

OPERATING MANUAL

MULTIPLE OUTPUT LINEAR SYSTEM DC POWER SUPPLY AGILENT MODELS 6625A, 6626A, 6628A, and 6629A

Agilent Part No 06626-90001



Agilent Technologies

CERTIFICATION

Agilent Technologies certifies that this product met its published specifications at time of shipment from the factory. Agilent Technologies further certifies that its calibration measurements are traceable to the United States National Bureau of Standards, to the extent allowed by the Bureau's calibration facility, and to the calibration facilities of other International Standards Organization members.

WARRANTY

This Agilent Technologies hardware product is warranted against defects in material and workmanship for a period of three years from date of delivery. Agilent software and firmware products, which are designated by Agilent for use with a hardware product and when properly installed on that hardware product, are warranted not to fail to execute their programming instructions due to defects in material and workmanship for a period of 90 days from date of delivery. During the warranty period Agilent Technologies will, at its option, either repair or replace products which prove to be defective. Agilent does not warrant that the operation of the software, firmware, or hardware shall be uninterrupted or error free.

For warranty service, with the exception of warranty options, this product must be returned to a service facility designated by Agilent. Customer shall prepay shipping charges by (and shall pay all duty and taxes) for products returned to Agilent for warranty service. Except for products returned to Customer from another country, Agilent shall pay for return of products to Customer.

Warranty services outside the country of initial purchase are included in Agilent's product price, only if Customer pays Agilent international prices (defined as destination local currency price, or U.S. or Geneva Export price).

If Agilent is unable, within a reasonable time to repair or replace any product to condition as warranted, the Customer shall be entitled to a refund of the purchase price upon return of the product to Agilent.

LIMITATION OF WARRANTY

The foregoing warranty shall not apply to defects resulting from improper or inadequate maintenance by the Customer, Customer-supplied software or interfacing, unauthorized modification or misuse, operation outside of the environmental specifications for the product, or improper site preparation and maintenance. **NO OTHER WARRANTY IS EXPRESSED OR IMPLIED. Agilent SPECIFICALLY DISCLAIMS THE IMPLIED WARRANTIES OF MERCHANTABILITY AND FITNESS FOR A PARTICULAR PURPOSE.**

EXCLUSIVE REMEDIES

THE REMEDIES PROVIDED HEREIN ARE THE CUSTOMER'S SOLE AND EXCLUSIVE REMEDIES. Agilent SHALL NOT BE LIABLE FOR ANY DIRECT, INDIRECT, SPECIAL, INCIDENTAL, OR CONSEQUENTIAL DAMAGES, WHETHER BASED ON CONTRACT, TORT, OR ANY OTHER LEGAL THEORY.

ASSISTANCE

The above statements apply only to the standard product warranty. Warranty options, extended support contracts, product maintenance agreements and customer assistance agreements are also available. Contact your nearest Agilent Technologies Sales and Service office for further information on Agilent's full line of Support Programs.

SAFETY SUMMARY

The following general safety precautions must be observed during all phases of operation, service, and repair of this instrument. Failure to comply with these precautions or with specific warnings elsewhere in this manual violates safety standards of design, manufacture, and intended use of the instrument. Agilent Technologies assumes no liability for the customer's failure to comply with these requirements.

BEFORE APPLYING POWER.

Verify that the product is set to match the available line voltage and the correct fuse is installed.

GROUND THE INSTRUMENT.

This product is a Safety Class 1 instrument (provided with a protective earth terminal). To minimize shock hazard, the instrument chassis and cabinet must be connected to an electrical ground. The instrument must be connected to the ac power supply mains through a three-conductor power cable, with the third wire firmly connected to an electrical ground (safety ground) at the power outlet. For instruments designed to be hard-wired to the ac power lines (supply mains), connect the protective earth terminal to a protective conductor before any other connection is made. Any interruption of the protective (grounding) conductor or disconnection of the protective earth terminal will cause a potential shock hazard that could result in personal injury. If the instrument is to be energized via an external autotransformer for voltage reduction, be certain that the autotransformer common terminal is connected to the neutral (earthed pole) of the ac power lines (supply mains).

FUSES.

Only fuses with the required rated current, voltage, and specified type (normal blow, time delay, etc.) should be used. Do not use repaired fuses or short circuited fuseholders. To do so could cause a shock or fire hazard.

DO NOT OPERATE IN AN EXPLOSIVE ATMOSPHERE.

Do not operate the instrument in the presence of flammable gases or fumes.

KEEP AWAY FROM LIVE CIRCUITS.

Operating personnel must not remove instrument covers. Component replacement and internal adjustments must be made by qualified service personnel. Do not replace components with power cable connected. Under certain conditions, dangerous voltages may exist even with the power cable removed. To avoid injuries, always disconnect power, discharge circuits and remove external voltage sources before touching components.

DO NOT SERVICE OR ADJUST ALONE.

Do not attempt internal service or adjustment unless another person, capable of rendering first aid and resuscitation, is present.

DO NOT EXCEED INPUT RATINGS.

This instrument may be equipped with a line filter to reduce electromagnetic interference and must be connected to a properly grounded receptacle to minimize electric shock hazard. Operation at line voltages or frequencies in excess of those stated on the data plate may cause leakage currents in excess of 5.0 mA peak.

SAFETY SYMBOLS.



Instruction manual symbol: the product will be marked with this symbol when it is necessary for the user to refer to the instruction manual (refer to Table of Contents) .



Indicates hazardous voltages.

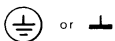

Indicate earth (ground) terminal.

WARNING

The WARNING sign denotes a hazard. It calls attention to a procedure, practice, or the like, which, if not correctly performed or adhered to, could result in personal injury. Do not proceed beyond a WARNING sign until the indicated conditions are fully understood and met.



The CAUTION sign denotes a hazard. It calls attention to an operating procedure, or the like, which, if not correctly performed or adhered to, could result in damage to or destruction of part or all of the product. Do not proceed beyond a CAUTION sign until the indicated conditions are fully understood and met.

DO NOT SUBSTITUTE PARTS OR MODIFY INSTRUMENT.

Because of the danger of introducing additional hazards, do not install substitute parts or perform any unauthorized modification to the instrument. Return the instrument to an Agilent Technologies Sales and Service Office for service and repair to ensure that safety features are maintained.

Instruments which appear damaged or defective should be made inoperative and secured against unintended operation until they can be repaired by qualified service personnel

SAFETY SUMMARY (continued)

GENERAL



















Any LEDs used in this product are Class 1 LEDs as per IEC 825-1.

This ISM device complies with Canadian ICES-001. Cet appareil ISM est conforme à la norme NMB-001 du Canada.

ENVIRONMENTAL CONDITIONS

This instrument is intended for indoor use in an installation category II, pollution degree 2 environment. It is designed to operate at a maximum relative humidity of 95% and at altitudes of up to 2000 meters. Refer to the specifications tables for the ac mains voltage requirements and ambient operating temperature range.

SAFETY SYMBOL DEFINITIONS

Symbol	Description	Symbol	Description
	Direct current		Terminal for Line conductor on permanently installed equipment
	Alternating current		Caution, risk of electric shock
	Both direct and alternating current		Caution, hot surface
	Three-phase alternating current		Caution (refer to accompanying documents)
	Earth (ground) terminal		In position of a bi-stable push control
	Protective earth (ground) terminal		Out position of a bi-stable push control
	Frame or chassis terminal		On (supply)
	Terminal for Neutral conductor on permanently installed equipment		Off (supply)
	Terminal is at earth potential (Used for measurement and control circuits designed to be operated with one terminal at earth potential.)		Standby (supply) Units with this symbol are not completely disconnected from ac mains when this switch is off. To completely disconnect the unit from ac mains, either disconnect the power cord or have a qualified electrician install an external switch.

Herstellerbescheinigung

Diese Information steht im Zusammenhang mit den Anforderungen der Maschinenläminformationsverordnung vom 18 Januar 1991.

* Schalldruckpegel $L_p < 70$ dB(A) * Am Arbeitsplatz * Normaler Betrieb

* Nach EN 27779 (Typprüfung).

Manufacturer's Declaration

This statement is provided to comply with the requirements of the German Sound Emission Directive, from 18 January 1991.

* Sound Pressure $L_p < 70$ dB(A) * At Operator Position * Normal Operation

* According to EN 27779 (Type Test).

Manufacturer's Name and AddressResponsible Party

Agilent Technologies, Inc.
550 Clark Drive, Suite 101
Budd Lake, New Jersey 07828
USA

Alternate Manufacturing Site

Agilent Technologies (Malaysia) Sdn. Bhd
Malaysia Manufacturing
Bayan Lepas Free Industrial Zone, PH III
11900 Penang,
Malaysia

Declares under sole responsibility that the product as originally delivered

Product Names

- a) Multiple Output 40 W and 80 W system dc Power Supplies
- b) Multiple Output 25 W and 50 W precision system dc Power Supplies

Model Numbers

- a) 6621A, 6622A, 6623A; 6624A, 6627A
 - b) 6625A; 6626A; 6628A; 6629A
- (and other customized products based upon the above)

Product Options

This declaration covers all options and customized products based on the above products.

Complies with the essential requirements of the Low Voltage Directive 73/23/EEC and the EMC Directive 89/336/EEC (including 93/68/EEC) and carries the CE Marking accordingly.

EMC Information

ISM Group 1 Class A Emissions

As detailed in Electromagnetic Compatibility (EMC), Certificate of Conformance Number CC/TCF/00/076 based on Technical Construction File (TCF) HPNJ3, dated Oct. 29, 1997

Assessed by: Celestica Ltd, Appointed Competent Body
Westfields House, West Avenue
Kingsgrove, Stoke-on-Trent
Staffordshire, ST7 1TL
United Kingdom

Safety Information

and Conforms to the following safety standards.

IEC 61010-1:2001 / EN 61010-1:2001
UL 1244
CSA C22.2 No. 1010.1:1992

This DoC applies to the above-listed products placed on the EU market after:



January 1, 2004

Date

Bill Darcy/ Regulations Manager

For further information, please contact your local Agilent Technologies sales office, agent or distributor.
Authorized EU-representative: Agilent Technologies Deutschland GmbH, Herrenberger Straße 130, D 71034 Böblingen, Germany

WHAT THIS MANUAL CONTAINS

It contains information relating to the installation, operation, and programming of these supplies as outlined below. Maintenance and troubleshooting instructions are given in a separate Service Manual (Agilent Part No. 06626-90003).

Chapter 1.--General Information

Chapter 1 contains a general description of the power supplies as well as instrument specifications and information concerning options and accessories.

Chapter 2.--Installation Procedures

Chapter 2 contains information to prepare the supply for use. Included in this chapter are power requirements, line voltage conversion, and GP-IB interface connections.

Chapter 3.--Getting Started

Chapter 3 contains a brief description of the supply's front panel controls and indicators and describes how to turn on the supply and to check its operation. An introduction to remote operation over the GP-IB is also given to help a first time user get started quickly.

Chapter 4.--Output Connections and Operating Information

Chapter 4 contains information about making connections to the supply's output terminals. General operating information is also provided.

Chapter 5.--Remote Operation

Chapter 5 contains all of the information required to operate the supply remotely via a GP-IB computer. All of the commands that can be used to program the supplies are described.

Chapter 6.--Local Operation

Chapter 6 contains instructions on using all of the front panel controls and indicators.

Appendix A--Calibration Procedure

Appendix A contains programming steps and procedures that are required to calibrate your power supply. It is recommended that the power supply be calibrated yearly.

Appendix B--Programming with Series 200/300 Computer

Appendix B contains Series 200/300 Computer programming examples (in Agilent extended BASIC language) for your Power Supply's most frequently used functions.

Appendix C--Command Summary

Appendix C contains an alphabetical listing of all commands that can be sent to a supply.

Appendix D--Error Messages

Appendix D contains a listing and brief explanation of all error codes and messages for all programming and hardware errors.

Appendix E - Manual Backdating

Appendix E contains backdating information for units with Serial numbers lower than those listed on the title page.

Table Of Contents

1	General Information	
	Introduction.....	11
	Safety Considerations.....	11
	Instrument and Manual Identification.....	11
	Options.....	11
	Accessories.....	12
	Description	12
	Basic Operation.....	14
	GP-IB Board.....	14
	Output Boards.....	15
	Specifications.....	15
	Qualifying Conditions.....	15
	Definitions.....	15
2	Installation	
	Introduction.....	25
	Initial Inspection.....	25
	Location and Cooling.....	25
	Input Power Requirements.....	26
	Line Fuse.....	27
	Power Cord.....	28
	Line Voltage Conversion.....	29
	GP-IB Interface Connection.....	29
3	Getting Started	
	Introduction	31
	Front Panel Controls and Indicators.....	31
	Turning On Your Supply.....	36
	Normal Self Test Indications.....	36
	Self Test Errors.....	37
	Checking Out Your Supply Using Local Control.....	37
	Voltage Test.....	38
	Overvoltage Test.....	38
	Current Test.....	38
	Changing Resolution Range	39
	Introduction To Remote Operation.....	39
	Enter/Output Statements.....	40
	Reading the GP-IB Address.....	40
	Changing the GP-IB Address.....	40
	Sending a Remote Command.....	41
	Getting Data from the Supply.....	41
	Often Used Commands.....	41
	Returning the Supply to Local Mode.....	43
4	Output Connections and Operating Information	
	Introduction	45
	Output Ranges.....	45
	Operating Quadrants.....	46
	Operating Range.....	47
	Protection Features.....	48
	Connecting The Load.....	49
	Wire Size Selection.....	49
	Multiple Loads.....	50

Table Of Contents (continued)

Positive and Negative Voltages.....	51
Remote Voltage Sensing.....	51
Remote Sense Connections.....	52
Output Noise Considerations.....	53
Programming Response Time with an Output Capacitor.....	53
Open Sense Leads.....	54
Overvoltage Trigger Connections.....	54
External Trigger Circuit.....	54
Power Supply Protection Considerations	55
Battery Charging.....	55
Capacitive Load Limitation.....	56
Parallel Operation.....	56
CV Operation.....	57
CC Operation.....	58
Remote Sensing.....	58
Specifications for Parallel Operation.....	58
Series Operation.....	59
CV Operation.....	59
CC Operation.....	60
Remote Sensing.....	60
Specifications for Series Operation.	60
Bi-Polar Operation	61
5 Remote Operation	
Introduction	63
GP-IB Operation.....	63
Interface Functions.....	63
GP-IB Address Selection.....	64
Power-On Service Request (PON)	65
Programming Syntax.....	65
Numeric Data.....	67
Order of Execution.....	70
Terminators.....	70
Initial Conditions.....	71
Power Supply Commands	71
Voltage Programming.....	71
Current Programming.....	73
Range Programming.....	73
Output On/Off.....	74
Overvoltage Protection.....	74
Overcurrent Protection.....	75
Multiple Output Storage and Recall.....	75
The Clear Command.....	76
Status Reporting.....	76
Service Request Generation.....	79
Reprogramming Delay.....	80
Display On/Off.....	81
Other Queries.....	82
6 Local Operation	
Introduction	85
Local Mode.....	85

Table Of Contents (continued)

	Local Control Of Output Functions.....	85
	General.....	85
	Setting Voltage and Voltage Range.....	86
	Setting Current and Current Range.....	87
	Enabling/Disabling an Output.....	87
	Setting Overvoltage Protection.....	88
	Resetting Overvoltage Protection.....	88
	Enabling/Disabling Overcurrent Protection.....	88
	Resetting Overcurrent Protection.....	88
	Local Control Of System Functions.....	88
	Setting the Supply's GP-IB Address.....	88
	Displaying Error Messages.....	89
	Storing and Recalling Voltage and Current. Settings for all Outputs.....	89
A	Alignment Procedures	
	Introduction.....	91
	Test Equipment and Setup Required.....	91
	Calibration Program.....	91
	Alignment Program.....	95
B	Programming With a Series 200/300 Computer	
	Introduction	103
	I/O Path Names.....	103
	Voltage and Current Programming.....	103
	Voltage and Current Programming With Variables... ..	104
	Voltage and Current Readback.....	104
	Programming Power Supply Registers.....	105
	Present Status.....	105
	Service Request and Serial Poll.....	106
	Error Detection	107
	Stored Operating States.....	108
C	Command Summary	
	Introduction	109
D	Error Messages	
	Introduction.....	117
	Power-On Self Test Messages.....	117
	Error Responses.....	117
	Test Responses.....	117
E	Manual Backdating	
	Introduction	121
	Make Changes.....	121
	Agilent Sales and Support Office	
	Contacts	122

General Information

Introduction

This chapter contains a general description of your power supply as well as its performance specifications. Information about options, accessories, and GP-IB cables is also provided. This manual describes the Agilent 6625A, 6626A, 6628A, and Agilent 6629A power supplies. Unless stated otherwise, the information in this manual applies to all of these models. Information that is specific to one model only is identified as such in this manual.

Safety Considerations

This product is a Safety Class 1 instrument, which means that it is provided with a protective earth terminal. This terminal must be connected to a power source that has a 3-wire ground receptacle. Review the instrument and this manual for safety markings and instructions before operation. Refer to the Safety Summary page at the beginning of this manual for a summary of general safety information. Safety information for specific procedures is located at appropriate places in this manual.

Instrument and Manual Identification

Agilent Technologies power supplies are identified by a two-part serial number, i.e. 2601A-00101. The first part of the serial number (the prefix) is a number/letter combination that denotes either the date of manufacture or the date of a significant design change. It also indicates the country of origin. (Starting at 1960, 26 = 1986; 01 = the first week of the year; A = U.S.A.) The second part of the serial number is a different sequential number assigned to each instrument starting with 00101.

Options

Options 100,120, 220, and 240 simply determine which line voltage is selected at the factory. For information about changing the line voltage setting, see line voltage conversion paragraph on page 29.

Option 750 consists of a fault indicator (FLT) and remote inhibit (INH) circuit and relay control, which provide additional shutdown protection should either the GP-IB and/or controller fail. This Option is described in a separate document entitled, "Appendix E Option 750 Operating Instructions for the Multiple Output Linear System DC Power Supply, Agilent Models 6621A, 6622A, 6623A, 6624A, and 6627A" (Agilent P/N 5957-6372).

- #100 Input power, 100 Vac, 47-66 Hz
- #120 Input power, 120 Vac, 47-66 Hz
- #220 Input power, 220 Vac, 47-66 Hz
- #240 Input power, 240 Vac, 47-66 Hz
- #750 Fault (FLT) Remote Inhibit (INH) and Relay Control
- #908 One rack mount kit (5062-3977)
- #909 One rack mount kit with handles (5062-3983)
- #0L2 One extra operating manual
- #0B3 One service manual

Accessories

10833A GP-IB cable, 1 m (3.3 ft)
 10833B GP-IB cable, 2 m (6.6 ft)
 10833C GP-IB cable, 4 m (13.2 ft)
 10833D GP-IB cable, 0.5 m (1.6 ft)
 10834A GP-IB connector extender
 Slide mount kit (1494-0059)

Description

The Agilent power supply features a combination of programming capabilities and linear power supply performance that make them ideal for systems applications. The models in this family offer a total of up to 200 watts of output power, with voltages up to 50 volts and currents up to 2 amps. The output combinations that correspond to each model are shown in Table 1-1. Each isolated output has a high resolution and standard resolution range, as shown in Figure 1-1.

Table 1-1 Output Combinations Available

Model	Output 1	Output 2	Output 3	Output 4
Agilent 6625A	25 W	50 W	--	--
Agilent 6626A	25 W	25 W	50 W	50 W
Agilent 6628A	50 W	50 W	--	--
Agilent 6629A	50 W	50 W	50 W	50W

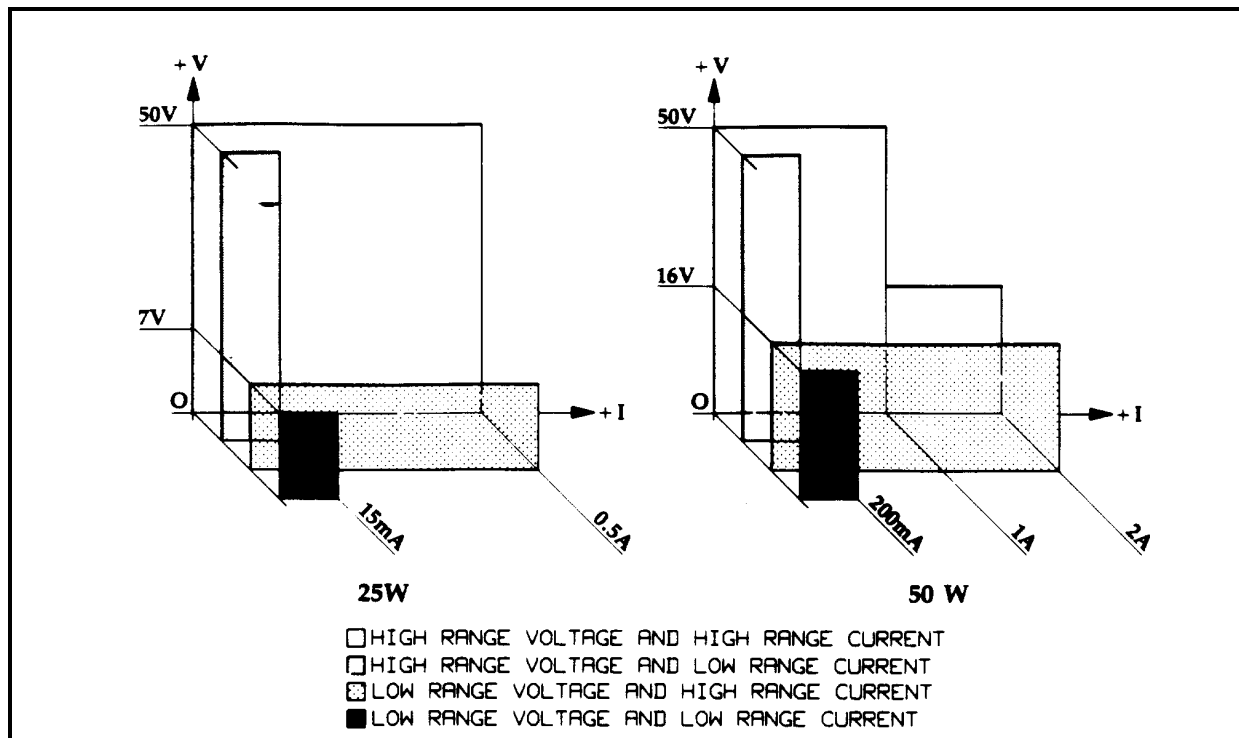

Figure 1-1. Output Operating Range

Output 2 of the Agilent 6625A and outputs 3 and 4 of the Agilent 6626A and all outputs of the Agilent 6628A and Agilent 6629A have an "L" shaped characteristic. The L shaped characteristic allows you to use the same output to power loads with different voltage and current requirements. The power supply automatically selects one of the operating ranges based on the last parameter (voltage or current) that is set. If a high resolution or a standard resolution application is required for either voltage or current, VRSET and IRSET should be used (see Appendix C-Command Summary). Additionally, each output contains an active downprogrammer, which means that voltage downprogramming can be accomplished as quickly as upprogramming, even without a load.

The power supplies allow up to a 10 volt sense lead drop. This feature makes them ideal for test system applications where remote sensing is used.

The output voltage and current for any output can be monitored with the front panel display. Output specific error messages are also displayed. Front panel annunciators show the operating status of the instrument. The front panel keypad lets you set and readback the voltage limit, current limit, and overvoltage trip level of any output. With the keypad, you can also enable or disable outputs, enable overcurrent protection, reset overvoltage and overcurrent protection, and return to local operating mode.

Your multiple output power supply can be both a listener and a talker on the GP-IB. (GP-IB is Agilent Technologies' implementation of IEEE-488). The built-in interface is tailored to the supply, resulting in simpler programming. Voltage and current settings can be sent directly to the specified output in volts and amps.

Service can be requested from your power supply for up to 10 reasons. The supply responds to a serial poll by identifying the output on which the fault occurred. Self-contained measurement and readback capability eliminate the need for externally scanning the outputs using a separate DVM. Upon command, the supply will measure its output voltage or current and return the value on the GP-IB. The following functions are implemented via the GP-IB:

- Voltage and current programming.
- Programmable resolution range.
- Voltage and current measurement and readback.
- Present and accumulated status readback.
- Programmable service request mask.
- Programmable overvoltage and overcurrent protection.
- Voltage and current range programming.
- Storage and recall of programmed voltage and current values for all outputs.
- Queries of programmed functions or settings.
- Output enable or disable.
- Programming syntax error detection.
- Programmable delay time for service request and OCP mask.
- Voltage, current, and overvoltage calibration.
- GP-IB interface selftest.
- Message display capability on the front panel.

Output connections are made to rear panel screw terminals. Either the positive or negative output terminal can be grounded, or the output can be floated up to ± 240 Vdc (including output voltage) from chassis ground. Output voltage can be locally or remotely sensed, and identical outputs can be operated in series or parallel combinations for increased output voltage or current capability. As shipped from the factory, the power supply is jumpered for local sensing.

Your power supply can be calibrated without having to remove the cover or even having to remove it from your system cabinet. This feature allows you to calibrate the supply at its normal operating temperature. The recommended calibration interval is one year. Refer to Appendix A of this manual for complete calibration details. A calibration security jumper is available inside the unit. Access is described in the service manual.

Basic Operation

Figure 1-2 is a block diagram that illustrates the major assemblies contained within the power supply. As shown in the figure, each supply includes a power transformer, two or more output boards, a GP-IB board, and front panel (display and control keys).

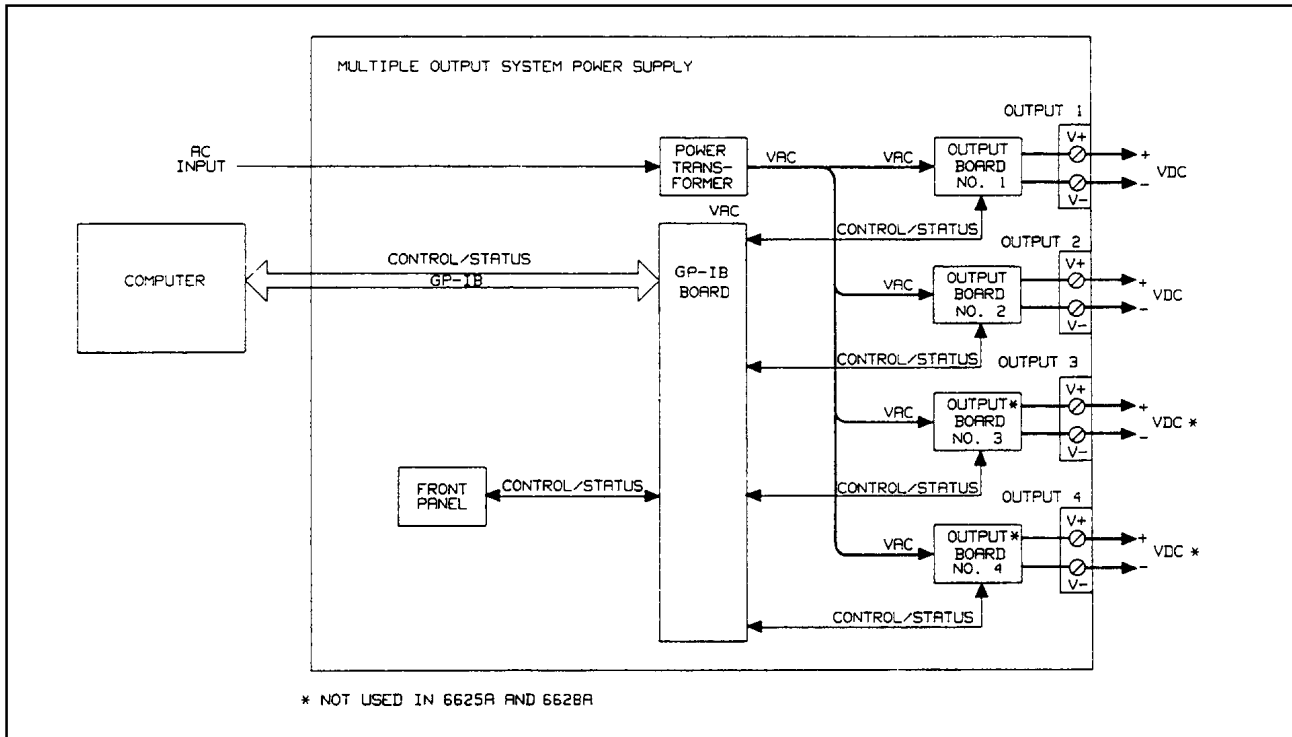

Figure 1-2. Block Diagram

The appropriate ac input voltage is applied to each output board where it is converted to a raw dc voltage which is subsequently linearly regulated to become the dc output voltage. The magnitude of the output and the mode of operation are determined by the load and the data received from the GP-IB computer or from the front panel.

Each power supply model contains one output board for each output that it provides.

GP-IB Board

The GP-IB board provides the interface between the user and the multiple outputs of the power supply. Each output board is actually an output channel that can be individually selected and controlled over the GP-IB or from the supply's front panel. Circuits on the GP-IB board interpret commands from the GP-IB or from the front panel to control the selected output.

The GP-IB board also processes measurement and status data received from the output boards. This data may be read back over the GP-IB and/or displayed on the supply's front panel.

The power supply has no potentiometers. Each output is individually calibrated over the GP-IB using calibration commands (see Appendix A). Correction factors are calculated by the power supply during calibration and are stored in a non-volatile memory which is located on the supply's GP-IB board. The supply contains no batteries.

Output Boards

The output boards are linear dc power supplies. Each isolated output operating boundary curve is shown in Figure 1-1.

The ac input to each output board is rectified and applied to a regulator circuit. Each output board employs series regulation techniques. A regulator element is connected in series with the load and operates in the linear region (between saturation and cutoff) of the transistor characteristic curve. Regulation is achieved by varying the conduction of the series element in response to a change in line voltage or circuit load.

The output board receives digital signals from the GP-IB board and converts them to analog signals which program the output voltage, current, and overvoltage values. The output may be programmed remotely over the GP-IB using commands (see Chapter 5) or locally from the supply's front panel using the control keys (see Chapter 6).

The output board can be commanded to send measurement and status data back over the GP-IB and/or front panel. The data is sent back via the supply's GP-IB board. GP-IB readback capabilities include output voltage and current, present and accumulated status, and all programmed settings. The front panel LCD display can indicate the output voltage and current, the supply's GP-IB address, error messages, and programmed values. Annunciators on the front panel indicate the operating status of the selected output (output board).

Specifications

Table 1-2 lists the performance specifications for the Agilent 662xA power supplies. Performance specifications describe the instrument's warranted performance. The service manual, Option 910, contains procedures for verifying the performance specifications.

Table 1-3 lists the supplemental characteristics for the Agilent 662xA supplies. Supplemental characteristics are type-tested or typical values, which are based on a product sample and, while representative, are not guaranteed.

Qualifying Conditions

All performance specifications apply over the full operating temperature range of the power supply (0 to 55°C) unless otherwise specified. All regulation, accuracy, etc. specifications are plus or minus the values listed. All measurements are made at the rear terminals of the supply with a resistive load and local sensing unless otherwise specified. Voltage measurements are made from the + S to the - S terminals. Overvoltage measurements are made from the + V to the - V terminals. + Current refers to the output acting as a current source while - Current refers to the output acting as a current sink.

Definitions

Load effect: Maximum steady state change in the regulated output parameter due to a change in load resistance on the output in question.

Source effect: Maximum steady state change in the regulated output parameter due to a change in the source voltage within rated values.

Cross regulation: Maximum steady state change in the regulated output parameter due to a change in load resistance on any other output(s).

Programming accuracy: (Calibration temp $\pm 5^\circ\text{C}$) Maximum difference between the programmed value and the actual output.

Readback accuracy: (Calibration temp $\pm 5^\circ\text{C}$) Maximum error in reading back an output parameter. Expressed as a percentage of the reading, plus a constant.

Output response time: Beginning at the time the power supply has finished processing a VSET command (change output voltage), the maximum time for the output voltage to settle to within a settling band about the final value from any specified operating point. This value must be added to the command processing time to obtain total programming time (see Figure 1-3). Time constant is the maximum time required for the voltage to reach 63% of its final value.

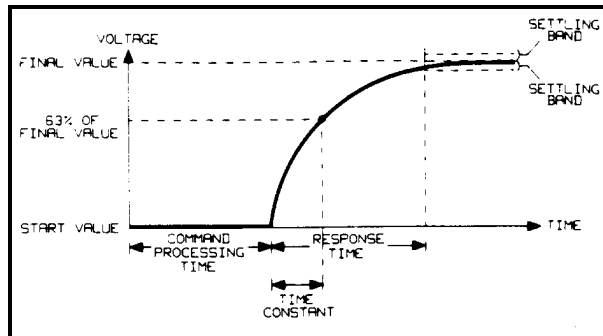

Figure 1-3. Output Response Characteristics

Temperature coefficient: Maximum change in the regulated output parameter per °C change in ambient temperature after a 30 minute warmup. Expressed as a percentage plus a constant per degrees C. (Plus a constant for readback temperature coefficient).

Long Term Drift: Maximum change of regulated output voltage or current during an 8-hour period following a 30 minute warmup, with all influence and control quantities maintained constant. Expressed as a percentage of the setting plus a constant.

Short Term Drift: Maximum change of regulated output voltage or current within 30 minutes after a line and/or load change. Expressed as a percentage of the setting plus a constant.

Output Noise (PARD): PARD replaces the former term ripple and noise. PARD is the periodic and random deviation of dc output voltage or current from its average value, over a specified bandwidth and with all influence and control quantities maintained constant.

Programming resolution: Average programming step size.

Current Sinking (- Current): Each output can sink as well as source current. The sinking capability is not programmable and depends upon the output voltage. The current sinking capability is described in greater detail in Chapter 4.

Table 1-2. Specifications

PERFORMANCE SPECIFICATIONS: (0 to 55 °C unless otherwise specified)				
DC Output Ranges: All outputs will accept voltage programming commands 1% higher than those listed and current programming commands 3% higher than those listed.				
Output Power	25 Watt Output		50 Watt Output	
	Lo Range	Hi Range	Lo Range	Hi Range
Output Range	0-7 V	0-50 V	0-16 V	0-50 V
Output Volts	0-15 mA	0-500 mA	0-200 mA	0-2 A
Output Amps				
Load Effect (Regulation):				
Voltage	0.5 mV	0.5 mV	0.5 mV	0.5 mV
+ Current	0.005 mA	0.005 mA	0.01 mA	0.015 mA

Table 1-2. Specifications (continued)

Source Effect:				
Voltage	0.5 mV	0.5 mV	0.5 mV	0.5 mV
+ Current	0.005 mA	0.005 mA	0.01 mA	0.01 mA
Programming Accuracy:				
Note: The programming accuracy specifications may degrade slightly when the unit is subjected to an RF field equal to or greater than 3 volts/meter.				
Voltage	0.016% + 1.5 mV	0.016% + 10 mV	0.016% + 3 mV	0.016% + 10 mV
+ Current	0.04% + 15 μ A	0.04% + 100 μ A	0.04% + 185 μ A	0.04% + 500 μ A
OVP	0.13% + 475 mV	0.13% + 475 mV	0.13% + 475 mV	0.13% + 475 mV
Measurement/Readback Accuracy*				
Voltage	0.016% + 2 mV	0.016% + 10 mV	0.016% + 3.5 mV	0.016% + 10 mV
\pm Current	0.03% + 15 μ A	0.03% + 130 μ A	0.04% + 250 μ A	0.04% + 550 μ A
Load Transient Recovery Time :(all outputs)				
75 μ S maximum to recover to within 75 mV of nominal value following a load change from 0.1 A to 100% of the maximum rated current				
Maximum Output Noise: (PARD) (20 Hz-20 MHz)				
CV pk-to-pk	3 mV	3 mV	3 mV	3 mV
CV rms	0.5 mV	0.5 mV	0.5 mV	0.5 mV
+CC rms	0.1 mA	0.1 mA	0.1 mA	0.1 mA
AC Input Voltage and Frequency:				
Nominal Line	100, 120, 220, or 240 Vac			
Amplitude	+6% to -13% of nominal line voltage			
Frequency	47 to 66 Hz			
Note at low line, the supply will operate with up to 3/4 ohm line resistance				

*For a $\pm 5^\circ$ C range about the calibration temperature

Table 1-3. Supplemental Characteristics

Output Power	25 Watt Output		50 Watt Output	
Output Range	Lo Range	Hi Range	Lo Range	Hi Range
Output Volts	0-7 V	0-50 V	0-16 V	0-50 V
Output Amps	0-15 mA	0-500 mA	0-200 mA	0-2 A
Temperature Coefficient-Programming:				
Voltage	(0.003%+0.1 mV) per $^\circ$ C	(0.003%+0.1 mV) per $^\circ$ C	(0.003%+0.1 mV) per $^\circ$ C	(0.003%+0.1 mV) per $^\circ$ C
+ Current	(0.0035% + 1.5 μ A) per $^\circ$ C	(0.0035% + 6 μ A) per $^\circ$ C	(0.0035% + 30 μ A) per $^\circ$ C	(0.0035% + 50 μ A) per $^\circ$ C
OVP	(0.013% + 1 mV) per $^\circ$ C	(0.013% + 2 mV) per $^\circ$ C	(0.013% + 1 mV) per $^\circ$ C	(0.013% + 2 mV) per $^\circ$ C

Table 1-3. Supplemental Characteristics (continued)

Output Power	25 Watt Output		50 Watt Output	
Output Range	Lo Range	Hi Range	Lo Range	Hi Range
Output Volts	0-7 V	0-50 V	0-16 V	0-50 V
Output Amps	0-15 mA	0-500 mA	0-200 mA	0-2 A
Temperature Coefficient-Measurement:				
Voltage	(0.002% + 0.1 mV) per° C +0.5 mV	(0.002% + 0.1 mV) per° C +4 mV	(0.002% + 0.1 mV) per° C +1 mV	(0.002% + 0.1 mV) per° C +4 mV
± Current	(0.0025% + 1.5 µA) per° C + 1 µA	(0.0025% + 10 µA) per° C + 40 µA	(0.0025% + 20 µA) per° C + 15 µA	(0.0025% + 50 µA) per° C + 150 µA
Long Term Drift: (In an 8 hour period following a 30 minute warm up)				
Voltage	0.006% + 0.5 mV	0.006% + 2 mV	0.006% + 0.5 mV	0.006% + 2 mV
+ Current	0.01% + 5 µA	0.01% + 20 µA	0.01% + 40 µA	0.01% + 60 µA
Short Term Drift: (Within 30 minutes after a line and/or load change):				
Voltage	0.002 + 0.5 mV	0.002 + 1 mV	0.002 + 0.5 mV	0.002 + 1 mV
+ Current	0.01% + 2 µA	0.01% + 20 µA	0.01% + 25 µA	0.01% + 60 µA
DC Floating Voltage:				
No output terminal may be more than 240 Vdc from any other terminal or from chassis ground. Also, no overvoltage terminal may be more than 240 Vdc from any other terminal or chassis ground.				
Remote Sense Capability: (see pages 50 - 52):				
Outputs can maintain specifications with up to 10 volt total in the remote sense leads.				
AC Input Power : 550 Watts				
Programming Resolution:				
Voltage	460 µV	3.2 mV	1 mV	3.2 mV
+ Current	1 µA	33 µA	13 µA	131 µA
OVP	230 mV	230 mV	230 mV	230 mV
Readback Resolution:				
Voltage	483 µV	3.3 mV	1.1 mV	3.3 mV
+ Current	1 µA	48 µA	14 µA	160 µA
- Current	1 µA	37 µA	14 µA	151 µA
Fixed Overvoltage Protection: (Measured at output terminals +V and -V)				
Minimum	56 V	56 V	56 V	56 V
Nominal	60 V	60 V	60 V	60 V
Maximum	64 V	64 V	64 V	64 V

Table 1-3. Supplemental Characteristics (continued)

High Line Inrush Current:	100 V Opt	120 V Opt	220 V Opt	240 V Opt
Peak Value	85 A	85 A	50 A	50 A
rms Value	6.3A	5.7 A	3.0 A	3.0 A
Fuse Rating	8 A	8 A	4 A	4 A
GP-IB Interface Capabilities:				
SH1, AH1, T6, L4, SR1, RL1, PP1, DC1, DT0, C0, E1				
Current Sink Capability:				
25 Watt output: 0.50 A				
50 Watt output: 1.0 A (2.0 A below 16 V)				
Command Processing Time: (see Figure 1-3)				
7 milliseconds typical (with front panel disabled). Using STD and RCL commands allows you to change all the voltage and current settings in about 10 mS (with front panel disabled).				
Maximum Output Programming:				
Response Time	6 mS	6 mS	6 mS	6 mS
Settling Band	50 mV	50 mV	50 mV	50 mV
Maximum Time				
Constant	750 μ S	750 μ S	750 μ S	750 μ S
Series and Parallel operation:				
Two outputs can be operated directly in parallel or can be connected for straight series operation. Refer to Chapter 4 for more information.				
Reactive Load Capability:				
All outputs have been designed with the ability to operate with significant reactive loads without instability (refer to Figures 1-4 through 1-6)				
Safety Agency Compliance:				
This series of power supplies is designed to comply with the following standards: IEC 348, UL 1244, and CSA 22.2 No. 231.				
Dimensions (all models):				
Height	132.6mm (5.22 in)			
Width	425.5mm (16.75 in.)			
Depth	497.8mm (19.6 in.)			

Table 1-3. Supplemental Characteristics (continued)

Weight:	Agilent 6625A, 6628A		Agilent 6626A, 6629A	
Net	15.5 kg (34 lbs.)		17.7 kg (39 lbs.)	
Shipping	20.8 kg (46 lbs.)		23 kg (51 lbs.)	
Load Cross Regulation:				
Voltage	0.25 mV	0.25 mV	0.25 mV	0.25 mV
+ Current	0.005 mA	0.005 mA	0.01 mA	0.01 mA

- ① ——— USING 14 AWG, 50 FOOT CABLE AND REMOTE SENSING
- ② - - - - USING 14 AWG, 5 FOOT CABLE AND REMOTE SENSING
- ③ ——— USING 20 AWG, 50 FOOT CABLE AND REMOTE SENSING
- ④ - - - - USING 20 AWG, 5 FOOT CABLE AND REMOTE SENSING
- ⑤ - - - - USING LOCAL SENSING AND CAPACITIVE LOAD RIGHT AT OUTPUT TERMINALS

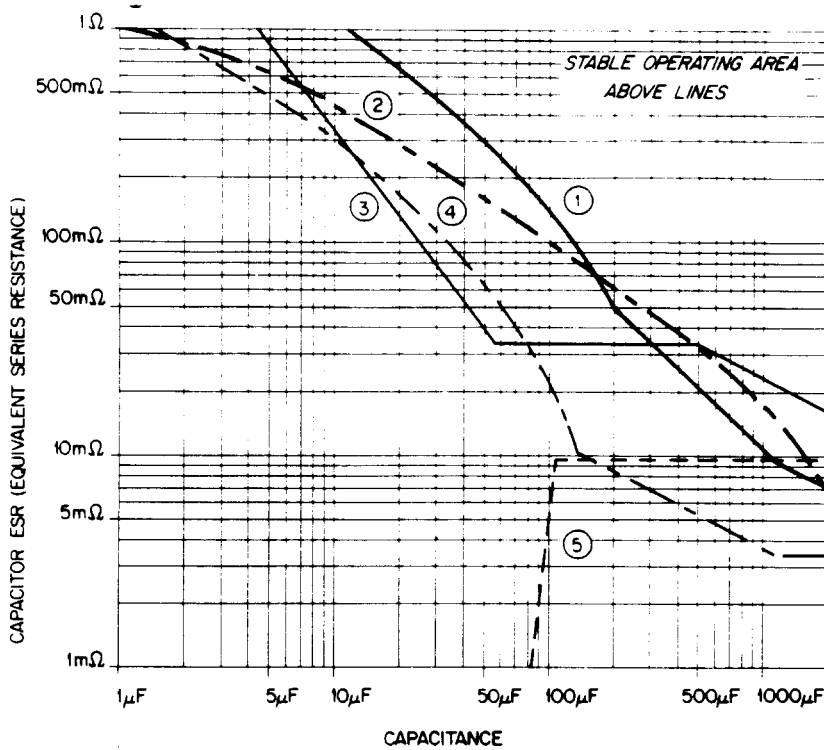

NOTE: CAPACITORS HAVING LOW CAPACITANCE AND LOW ESR (E.G. CERAMIC AND FILM CAPACITORS) ARE NOT RECOMMENDED FOR USE AS BYPASS CAPACITORS AT THE END OF A LONG LOAD CABLE (SEE ILLUSTRATION BELOW). THIS TYPE OF CAPACITOR MAY CAUSE THE OUTPUT TO BECOME UNSTABLE BECAUSE OF RESONANCE EFFECTS WITH THE LOAD LEAD INDUCTANCE. MOST ALUMINUM AND TANTALUM CAPACITORS FALL WITHIN THE STABLE OPERATING AREA OF THE GRAPHS SHOWN ABOVE. REFER TO PARAGRAPHS 4-6 THROUGH 4-14 FOR ADDITIONAL INFORMATION ABOUT CONNECTING LOAD LEADS AND REMOTE SENSE LEADS.

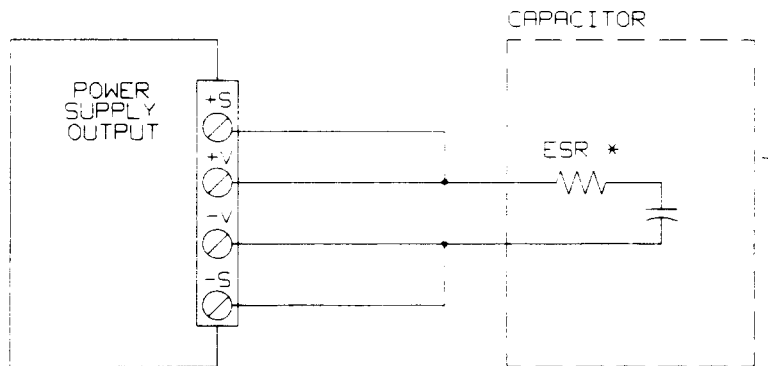

* EQUIVALENT SERIES RESISTANCE

Figure 1-4. CV Operation with Capacitive Load, Stability Graph for all Outputs

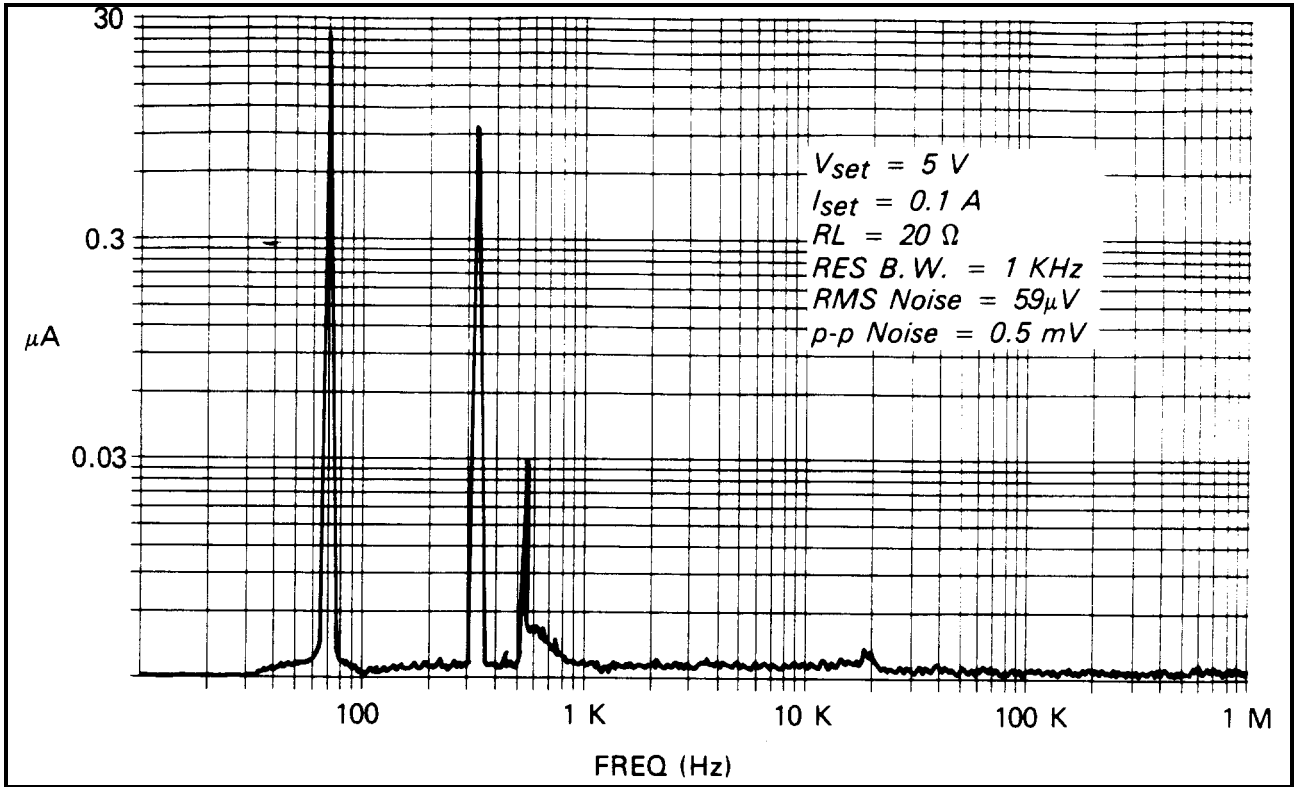

Figure 1-5. Output Noise (Typical) CC Mode

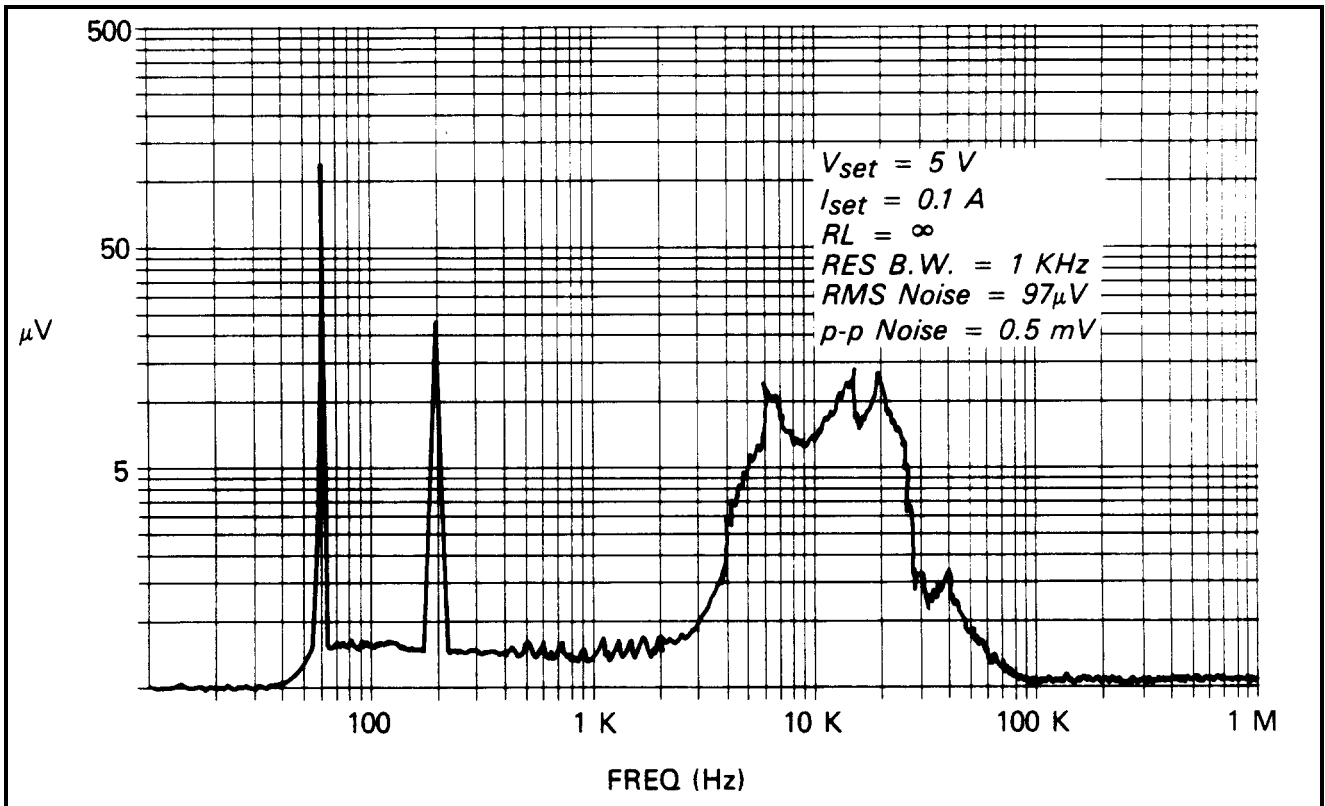

Figure 1-6. Output Noise (Typical) CV Mode

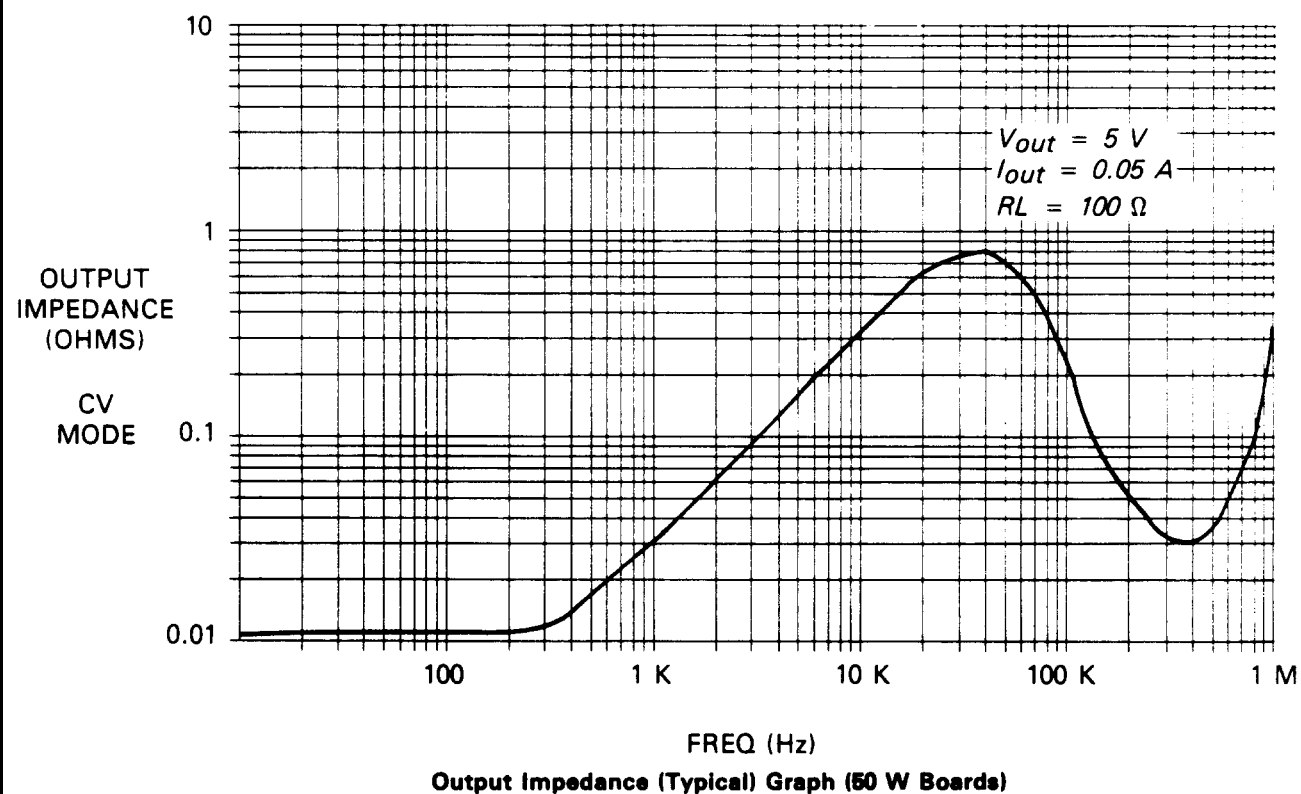
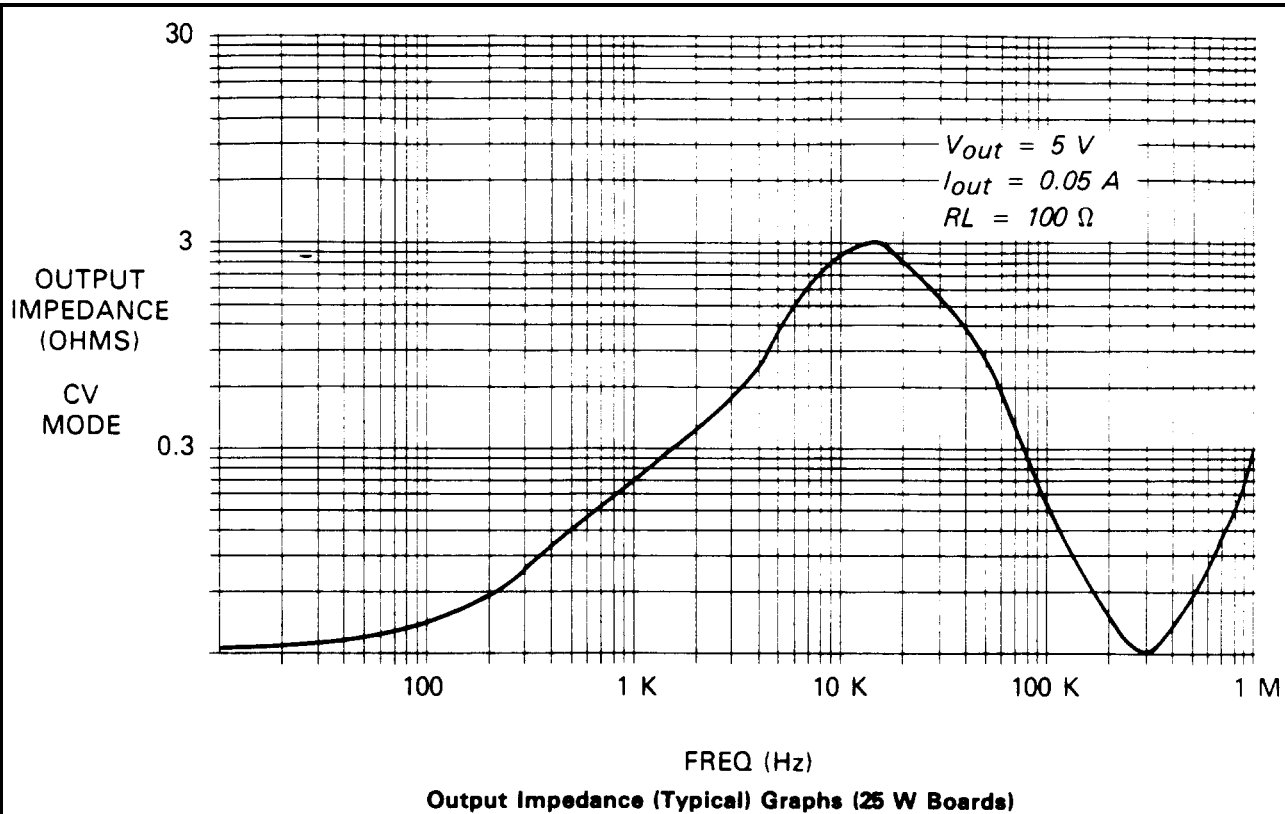

Figure 1-7. Output Impedance (Typical) Graph (See Supplemental Characteristics)

Installation

Introduction

This chapter contains instructions for checking and mounting your power supply, connecting your supply to ac power, converting it from one line voltage to another, and connecting the GP-IB cable.

The power supply generates operating magnetic fields which may affect the operation of other instruments. If your instrument is susceptible to magnetic fields, do not locate it in the immediate vicinity of the power supply. Typically, at three inches from the power supply, the electromagnetic field is less than 5 gauss.

Initial Inspection

Your instrument was thoroughly inspected and tested before it left the factory. As soon as you receive it, remove the power supply from its packing case and check to make sure it has not been damaged in shipment. Check that there are no broken connectors or keys, and that the cabinet and panel surfaces are free from dents and scratches. Check the rear panel terminal blocks and front panel display for any cracks. If damage is found, you should file a claim with the carrier immediately and notify the Agilent Technologies Sales and Service office nearest you.

Chapter 3 of this manual includes an electrical turn-on check-out procedure which, when carried out successfully, will give you a high level of confidence that the power supply is operating in accordance with its specifications. Detailed electrical checks complete with verification procedures are included in the Service Manual.

Keep the original packing materials for the carrier's inspection if there was damage, or in case any equipment has to be returned to Agilent Technologies. Warranty information is printed on the inside cover of this manual. Remember to send a detailed description of the failure and symptoms when returning the power supply for service. Your Agilent Technologies Sales and Service office will furnish the address of the nearest service office to which the instrument can be shipped.

Location and Cooling

Your power supply can operate without loss of performance within the temperature range of 0 to 55 ° C (measured at the fan intake). The fan, located at the rear of the unit, cools the supply by drawing air in through the openings on the rear panel and exhausting it through openings on the sides. Using Agilent Technologies rack mount kits will not impede the flow of air.

Because the power supply is fan cooled, it must be installed in a location that allows sufficient space at the rear and the sides for adequate circulation of air. Either side may be restricted to have as little as 1 inch (25 mm) space.

Figure 2-1 gives the dimensions of the power supply cabinet. These dimensions apply to both models. The cabinet has plastic feet that are shaped to ensure self-alignment when stacked with other Agilent Technologies System II cabinets. The feet may be removed for rack mounting.

The power supply can be mounted in a standard 19 inch rack panel or enclosure. Rack mounting accessories for this unit are listed under options (page 11) of Chapter 1. Complete installation instructions are included with each rack mounting kit. Instrument support rails are required for non-stationary installations. These are normally supplied with the cabinet and are **not** included with the rack mounting kits.

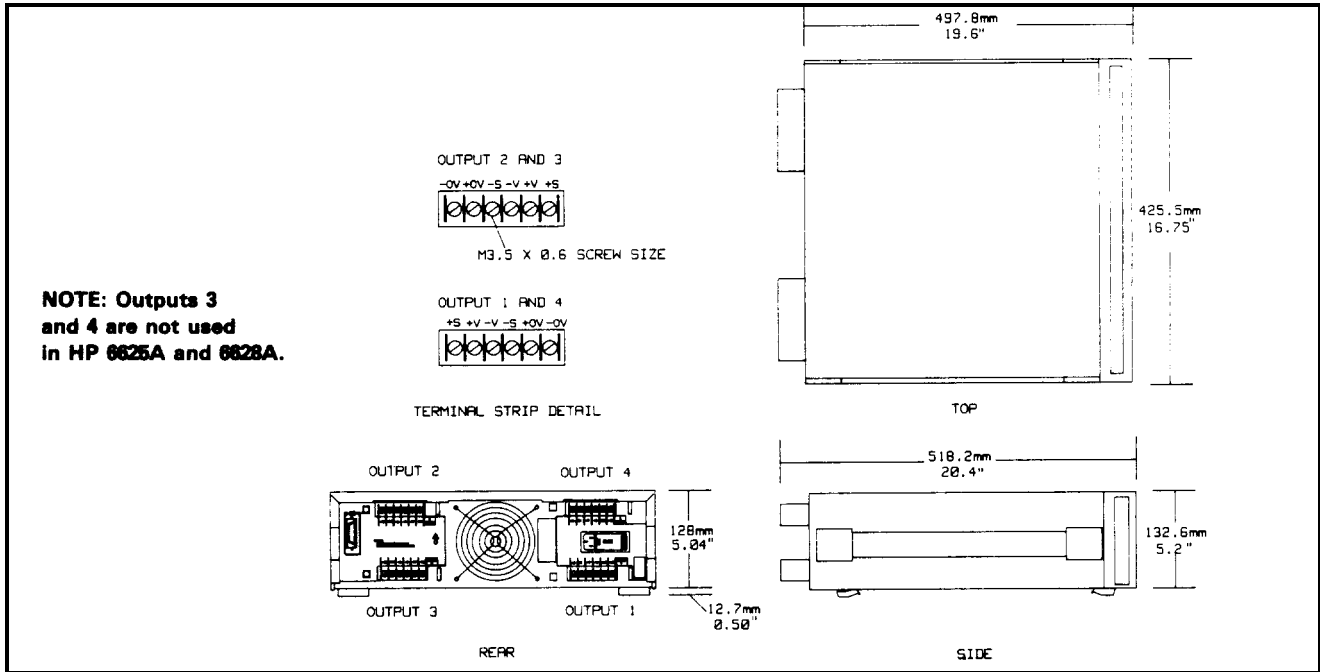

Figure 2-1. Outline Diagram

Input Power Requirements

You can operate this power supply from a nominal 100 V, 120 V, 220 V or 240 V single phase power source at 47 to 66 Hz. The input voltage range, maximum input current, high line inrush current (PK), and the fuse required for each of the nominal inputs are listed in Table 2-1. You can check the line voltage setting of your supply by examining the door on the line module. This is located on the rear panel of your supply as shown in Figure 2-2. The red mark that appears in one of the four windows on the line module indicates the line voltage setting for which your supply is set.

If necessary, you can convert the supply from one line voltage setting to another by following the instructions under LINE VOLTAGE CONVERSION (see page 29).

Table 2-1. Input Power

Nominal Voltage	Line Voltage Range	Maximum Input Current (rms.)	High Line Inrush Current (PK)	Fuse
100 V	Nominal -13%, +6%	6.3 A	85 A	8 AM
120 V		5.7 A	85 A	8 AM
220 V		3.0 A	50 A	4 AM
240 V		3.0 A	50 A	4 AM

Line Fuse

The ac line fuse is located behind the door on the line module (see Figure 2-3). To access the fuse, remove the power cord and push against the tab on the line module in the direction of the ac input socket. The current rating of the fuse is based on the line voltage setting of your supply. Table 2-2 gives the Agilent part numbers for the fuses that should be used with specific line voltages.

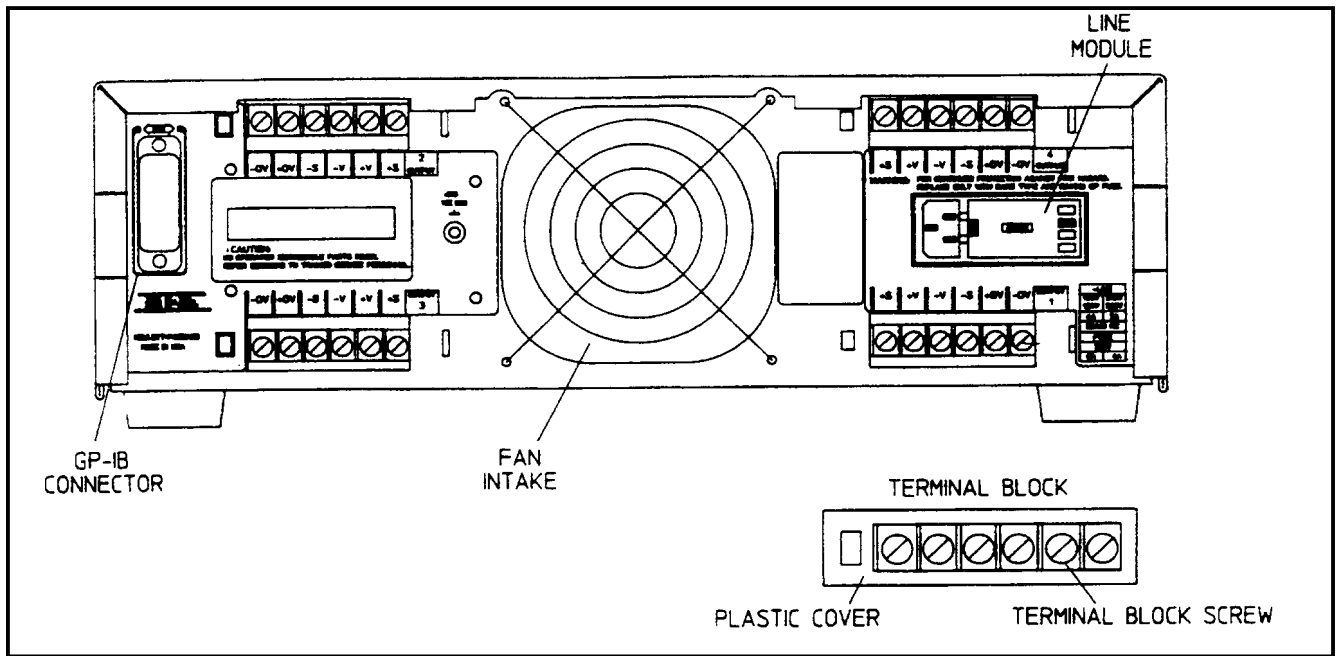

Figure 2-2. Rear Panel Detail (Agilent 6626A Shown)

Table 2-2 Line Fuses

Line Voltage	Fuse Needed	Agilent Part Number (for ¼ X 1¼ in. fuses only)
100/120 V	8AM	2110-0342
220/240 V	4AM	2110-0055

Note: All fuses are rated for 250 V.

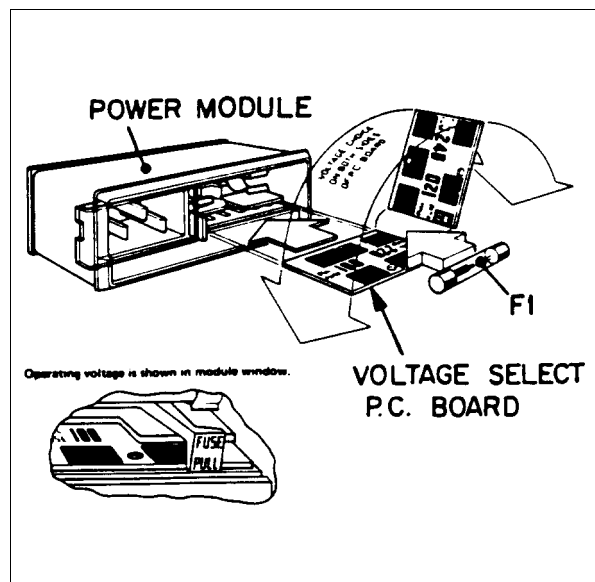

Figure 2-3. Line Module Detail

Power Cord

The power supply is shipped from the factory with a power cord that has a plug appropriate for your location. Figure 2-4 shows the standard configuration of plugs used by Agilent Technologies. Below each drawing is the Agilent part number for the replacement power cord equipped with a plug of that configuration. If a different power cord is required, contact the nearest Agilent Technologies Sales and Service office.

For your protection, the National Electrical Manufacturer's Association (NEMA) recommends that the instrument panel and cabinet be grounded. This power supply is equipped with a three-conductor power cord; the third conductor being the ground. The power supply is grounded only when the power cord is plugged into an appropriate receptacle. Do not operate this power supply without adequate cabinet ground connection.

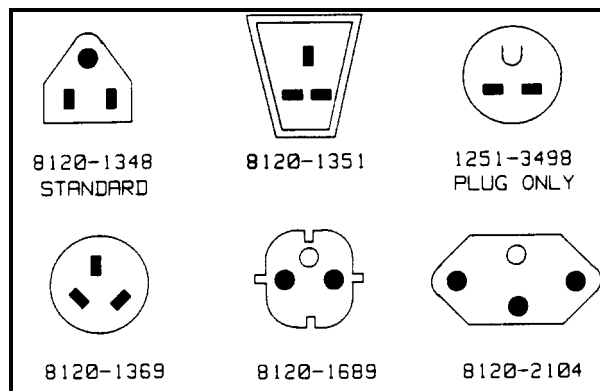

Figure 2-4. Power Cord Plug Configurations

WARNING

SHOCK HAZARD. Connect the power cord to a grounded receptacle before you connect any external floating voltages to the supply.

The offset pin on the standard three-prong power cord connector is the ground connection. If a two contact receptacle is encountered, it must be replaced with a properly grounded three-contact receptacle in accordance with the National Electrical Code, local codes and ordinances. The work should be done by a qualified electrician.

Line Voltage Conversion

You can change the supply to accept 100 V, 120 V, 220 V and 240 V ac input by adjusting the voltage selector card located inside of the line module (see Figure 2-3). After you have changed the line voltage, refer to Table 2-2 and check that the fuse inside the line module is the correct fuse for that line voltage. The procedure is as follows:

1. Turn off power and remove the power cord from the ac input socket on the back of the power supply.
2. To open the line module, move the plastic door on the module aside. If your line voltage change requires a change in the rating of the fuse, rotate FUSE PULL to the left and remove the fuse.
3. Grasp the voltage select pc board with a pair of needle-nose pliers and slide it out of its slot.
4. To select a voltage, orient the pc board so that the desired voltage appears on the top left side of the board. Push the board all the way back into its slot. The desired line voltage must be visible when the board is installed.
5. Install the correct fuse in the door of the line module if your line voltage change also requires a change in the rating of the fuse (see Table 2-2).

WARNING

FIRE HAZARD. Make sure the replacement fuse is one of the same type (size) and rating (amps) that is consistent with the voltage level you are operating at. Do not use a substitute fuse; use a fuse with the same Agilent Part number listed in Table 2-2.

6. Close the door of the line module and insert the power cord in the ac input socket. Your power supply is now configured to operate at the voltage you selected.

GP-IB Interface Connector

The GP-IB connector on the rear panel connects your power supply to your computer and other GP-IB devices (see Figure 2-2). Accessories (page 12) in Chapter 1 lists the cables and cable accessories that are available from Agilent Technologies. An GP-IB system can be connected together in any configuration (star, linear, or both) as long as the following rules are observed

1. The total number of devices, including the computer, is no more than 15.
2. The total length of all the cables used is no more than two meters times the number of devices connected together, up to a maximum of 20 meters.

Note IEEE Std. 488-1978 states that you should exercise caution if your individual cable lengths exceed 4 m.

Do not stack more than three connector blocks together on any GP-IB connector. The resultant leverage can exert excessive force on the mounting panels. Make sure that all connectors are fully seated and that the lock screws are firmly finger tightened. Do not use a screwdriver. Use a screwdriver only for the removal of the screws.

Getting Started

Introduction

This chapter is intended for the first time user of the supply. It provides four main discussions:

- Front Panel Controls and Indicators
- Turning on Your Supply
- Checking Out Your Supply Using Local Control
- Introduction to Remote Operation

First, the supply's front panel controls and indicators are briefly described. Some of the controls and indicators will be used in the Turn On And Checkout procedures that follow. Chapter 6 describes how to use all of the front panel controls.

Successful completion of the Turn On And Checkout procedures ensures with a high level of confidence that your supply is operating properly. Complete performance testing and troubleshooting procedures are given in the Service Manual (Agilent Part No. 06626-90003).

The checkout procedures are performed locally from the front panel. In addition to checking the operation of your supply, these simple step-by-step checkout procedures will help the first time user become familiar with operating the supply from the front panel.

When you have completed the checkout procedures, you are then introduced to the fundamentals of operating the supply remotely from a computer. You will learn how to send a command to the supply from the computer and how to get data back to the computer from the power supply. A few of the most often used power supply commands will be described to help you get started and become familiar with the basics of programming your supply.

After completing this chapter, you can proceed to Chapter 4 to find out how to make load connections to your supply's outputs and then to Chapter 5 (Remote Control) and/or Chapter 6 (Local Control) to learn all the details about operating your supply.

Front Panel Controls and Indicators

The power supply's controls and indicators are shown in Figure 3-1 and are described in Table 3-1. Note that the front panel controls are identical for all models except for the number of OUTPUT annunciators (number 3 in Figure 3-1).

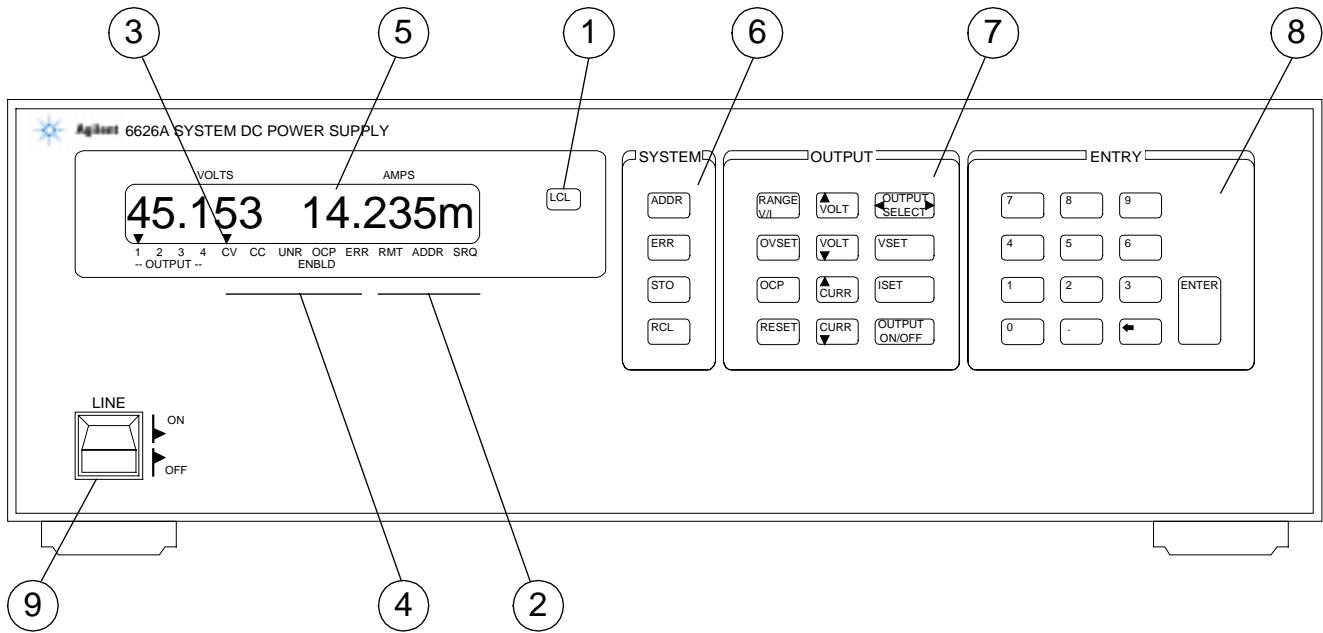

Figure 3-1. Agilent 6626A Front Panel

Table 3-1. Controls and Indicators

Number	Controls/Indicators	Description	Page
1	LCL key	Returns power supply to local mode (unless local lockout has been received via GP-IB). Also, turns the power supply's display on if it was turned off via the GP-IB.	3-13, 5-2, 6-1
2	GP-IB Status Annunciators (These three annunciators indicate the GP-IB status of the power supply).	RMT - Indicates that the power supply is operating under remote control (GP-IB) ADDR - Indicates that the power supply is addressed to talk or to listen. SRQ - Indicates that the power supply is requesting service.	3-13, 5-2, 6-1, 3-10, 5-1 5-1, 5-2, 5-3, 5-17
3	OUTPUT Annunciators	Indicate which output channel has been selected for front panel control and/or display (Only one output annunciator can be on at a time.)	3-7, 3-8, 6-1--6-4
4	Power Supply Status Annunciators (These five annunciators indicate the status of the power supply).	CV - Indicates that the selected output channel is in the constant voltage mode. CC - Indicates that the selected output channel is in the positive constant current mode (+ CC) or the negative current limit (- CC) mode.	3-8, 4-1, 6-2, 6-3 3-8, 4-1, 6-2, 6-3

Table 3-1. Controls and Indicators (continued)

Number	Controls/Indicators	Description	Page
4 (cont)		<p>UNR- Indicates that the selected output channel is unregulated; i.e., it is not regulated by CV or CC control loops.</p> <p>OCP ENBLD - Indicates that the overcurrent protection function for the selected channel is enabled.</p> <p>ERR - Indicates that a programming or hardware error has occurred and that the ERR bit in the serial poll register has not been cleared</p>	<p>4-4</p> <p>3-8, 6-4, 5-13</p> <p>4-4, 5-16</p>
5	<p>Alphanumeric LCD Display (When power is turned on, all segments will be displayed for approximately 2 seconds).</p>	<p>Normally displays the measured output voltage and current for the selected channel. When programmed from the front panel, the function being programmed (e.g. VSET), the output channel (e.g. 2), and the present value (e.g. 2.250) will be displayed. Error conditions will be spelled out in alpha characters</p>	<p>3-7--3-10, 4-4, 5-19, 5-20, 6-1--6-4</p>
6	<p>System Control Keys (These four control keys affect the entire power supply and are independent of the output selected.)</p>	<p>ADDR - Displays the power supply's GP-IB address. You can change the address using the numeric entry keys. You cannot query or change the address remotely (over the GP-IB).</p> <p>ERR - Displays a programming or hardware error message and clears the ERR bit in the serial poll register</p> <p>STO - Used in conjunction with the numeric entry keys to store the present output conditions for all outputs in the specified internal register (0-10). Each register stores the following parameters: VSET, VRSET, ISET, IRSET, and OVSET. In addition, register 0 also stores OCP, DLY, and MASK parameters. Register 0-3 are non-volatile.</p> <p>The parameters stored in register 0 are the "power-up" parameters. These parameters are set upon applying AC power to the power supply. Note that the STO command cannot be used over the bus more than once per non-volatile register (0-3) without cycling the AC power (OFF and ON). However, these registers can be used for an unlimited number of times via the front panel keys without cycling the AC power .</p> <p>RCL - Used in conjunction with the numeric entry keys to recall the settings from the specified internal register (0 to 10). All outputs are set to the recalled values.</p>	<p>3-10, 5-2, 6-4</p> <p>5-1, 5-20</p> <p>5-1, 5-13</p> <p>5-1, 5-13</p>

Table 3-1. Controls and Indicators (continued)

Number	Controls/Indicators	Description	Page
7	<p>Output Control Keys (These twelve keys are output dependent).</p>	<p>OUTPUT SELECT - Selects one of the output channels for local control or display. This key allows the channels to be selected in forward (➔) or reverse (➜) sequence.</p> <p>VSET - Displays the selected output's present voltage setting. The setting can be changed using the numeric entry keys, ⬆ VOLT, or ⬇ VOLT keys..</p> <p>ISET - Displays the selected output's present current setting. The setting can be changed using the numeric entry keys, ⬆ CURR, or ⬇ CURR keys.</p> <p>OUTPUT ON/OFF - Toggles the selected output on and off. When off, "DISABLED" appears on the display.</p> <p>OVSET - Displays the selected output's overvoltage trip point. The setting can be changed using the numeric entry keys.</p> <p>RANGE V/I - Displays the selected output's full scale programming range for voltage and current. This key also enables the Up/Down keys to change the programming range.</p> <p>Up/Down Keys - These keys increment or decrement the voltage or current settings of the output selected. The display will be in the metering mode for the output selected. When one of the keys is pressed, it will change the output selected by one least significant bit (LSB). If the key is pressed and held, it will continually change the setting until it is released The ⬆ VOLT key is disabled when the supply is in the CC mode. The ⬇ CURRENT key is disabled when the supply is in the CV mode.</p> <p>These keys will also allow you to change the programmed resolution range of voltage or current after the RANGE V/I key is depressed.</p> <p>⬆ VOLT - Increases the selected output voltage by an LSB and then a faster rate as the key is kept pressed, or after the RANGE V/I key has been pressed, sets the selected output to the high voltage range.</p> <p>⬇ VOLT - Decreases the selected output voltage by an LSB and then at a faster rate as the key is kept pressed, or after the RANGE V/I key has been pressed, sets the selected output to the low voltage range.</p>	<p>3-7, 3-8, 6-1--6-4</p> <p>3-8, 3-9, 5-9, 5-11, 6-2</p> <p>3-8, 5-11, 6-3</p> <p>5-12, 6-3</p> <p>3-8, 5-12, 6-4</p> <p>3-9</p> <p>3-9, 6-2, 6-3</p> <p>3-9</p> <p>3-9, 6-2</p> <p>3-9, 6-2</p>

Table 3-1. Controls and Indicators (continued)

Number	Controls/Indicators	Description	Page
7 (cont)		<p>↑ CURRENT - Increases the selected output current by an LSB and then at a faster rate as the key is kept pressed, or after the RANGE V/I key has been pressed, sets the selected output to the high current range.</p> <p>↓ CURRENT - Decreases the selected output current by an LSB and then at a faster rate as the key is kept pressed, or after the RANGE V/I key has been pressed, sets the selected output to the low current range.</p> <p>OCP - Toggles the selected output's overcurrent protection circuit on and off.</p> <p>RESET - This key performs the following:</p> <ol style="list-style-type: none"> 1. Reset the selected output's overvoltage crowbar (the cause of the overvoltage must be removed before reset is successful) . 2. Reset the selected output's overcurrent condition and returns the output to its previous settings (the cause of the overcurrent must be removed before reset is successful). 3. Return the display to the metering mode from any other mode (e.g. VSET). In the metering mode, the measured output voltage and current of the selected output are displayed . 	<p>3-9, 6-3</p> <p>3-9, 6-3</p> <p>3-8</p> <p>3-8</p>
8	<p>Numeric Entry Keys (These keys are used in conjunction with many of the System Control and Output Control keys to enter the desired values into the power the metering mode. Supply.</p>	<p>0 to 9 - Set the value of the specified function and and (e.g. VSET 1 6.550)</p> <p>.</p> <p>←(backspace) - Erases the previous keystroke. Depressing this key without setting a value places the display in</p> <p>ENTER - Enters the values on the display for the specified function, initiates the function, and returns the display to the metering mode. Pressing this key without setting a value will result in retention of the previous values and returning the display to the metering mode.</p>	<p>3-8, 6-1--6-5</p> <p>6-1</p> <p>3-8, 6-1--6-5</p>
9	<p>LINE switch</p>	<p>Turns ac power on and off.</p>	<p>3-6</p>

Table 3-1, in addition to providing a brief description of each control and indicator, lists the paragraphs in which the use of each control and indicator is described. Because most of the functions performed by the front panel controls can also be performed remotely by power supply commands, the corresponding paragraphs in Chapter 5 (Remote Operation) are listed in Table 3-1 where applicable.

Turning On Your Supply

The following paragraphs describe the power-on sequence which includes a self test of most of the power supply's circuits.

Before you turn on your supply, make sure that:

- The line module on the rear panel is set to match your input line voltage.
- The proper fuse is installed and the line cord is plugged in.

If you have any questions concerning installation or power requirements, review Chapter 2.

To turn on your supply, press the front panel LINE switch. When the power is initially applied, the supply performs a series of self tests which last about 3 seconds. Included in these tests are checks of circuits on the GP-IB board and on each of the output boards.

Normal Self Test Indications

If the supply passes the self test, the display will first show all segments of the LCD display with annunciators on as illustrated in Figure 3-2.

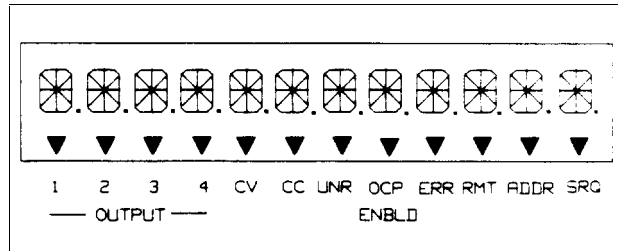

Figure 3-2. Test Pattern of all Display Segments at Power-on

After all segments are displayed, the supply's GP-IB address will appear for approximately 2 seconds as shown in Figure 3-3. As shipped from the factory, the power supply's address is set to 5. You must know this address before you can remotely program your supply.

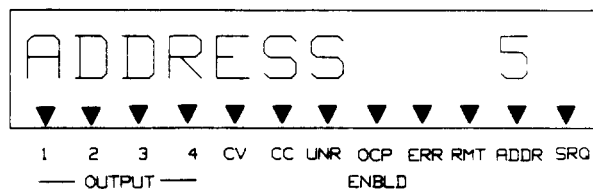

Figure 3-3. Typical Address Display During Power-On Self Test

When self test is successfully completed, the power-up parameters stored in register 0 will be set (see page 89 for a complete description of the store and recall functions). As shipped from the factory, this non-volatile register contains zero volts and zero current (see Table 5-4 on page 72) for all outputs. Note that the CV annunciator will indicate that the output is in the constant voltage mode.

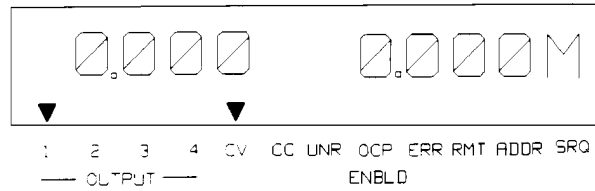

Figure 3-4. Typical Display at Power-On

Self-Test Errors

If the supply fails the power-on self-test, all power supply outputs will remain disabled (off) and the display will indicate the type of failure and the output channel on which it occurred. Figure 3-5 shows that self-test detected an error in output channel 3. Error messages that could appear on the display if self-test fails are listed below. Self-test error messages are explained in Appendix D and troubleshooting procedures are given in the Service Manual. You may also call your Agilent Sales Office for help.

Power-On Self Test Error Messages

HDW ERR CH "N"
 8291 FAILED
 TIMER FAILED
 CV DAC CH "N"
 CC DAC CH "N"
 OV DAC CH "N"
 FUSE CH "N"

Note: "N" specifies the failed output channel number: 1,2,3, or 4 as applicable.

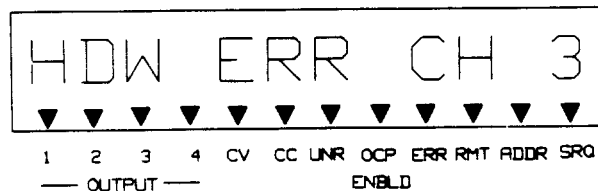

Figure 3-5. Sample Self-Test Failure Display

Checking Out Your Supply Using Local Control

The following procedures use the display and keys on the front panel to check each of your power supply's outputs. No test equipment, other than a jumper wire (14 AWG), is required to perform these tests. The tests must be repeated for each output of your particular supply. The checkout consists of voltage, overvoltage, and current tests. It is assumed that power has already been turned on, the supply has passed the power-on self-test, loads are not connected to any of the supply's outputs, and sense clips are connected between the sense terminals and the output terminals.

Note

The following procedures are identical for all models and for all outputs. Use the OUTPUT SELECT key to select an output to be tested. If an output fails any of the tests, refer to the troubleshooting section in the Service Manual.

Voltage Test

1. Set the voltage of the selected output to 10 V by pressing:

2. Check that the display reads approximately 10 V and 0 A and the CV annunciator is on indicating that the supply is in the constant voltage mode of operation.

Overvoltage Test

1. Program the overvoltage protection (OVP) to 19 V by pressing:

2. Set the voltage to 16 V by pressing:

3. Check that the display reads approximately 16 V and 0 A.

4. Set the voltage to 20 V by pressing:

5. Check that the display reads "OVERVOLTAGE"

6. Reset the supply by pressing:

7. Check that the display reads approximately 16 V and 0 A.

Current Test

1. Turn off the supply.

2. Remove the barrier block cover from the output to be tested and connect a short circuit (jumper wire) between the + V and -V terminals of the output being tested.

3. Turn on the supply.

4. Use the to select the output being tested.

5. Set the voltage to a volts by pressing:

Set the current to 0.01 amps by pressing:

6. Check that the display reads approximately 0 volts and the programmable current limit value. Also, check that the front panel CC annunciator is on indicating that the output is in the constant current mode of operation.

7. Set the current to 0.5 A by pressing:



8. Check that the display reads approximately 0 V and 0.5 A.

9. Enable the overcurrent protection circuit by pressing:



10. Check that the OCP ENBLD annunciator is on indicating that overcurrent protection is enabled and the display reads "OVERCURRENT". When in overcurrent, the output is disabled.

11. Disable the overcurrent protection circuit by pressing:



12. Reset the output by pressing:



13. Check that the display reads approximately 0 V and 0.5 A.



14. Turn off the supply and remove the jumper from the output terminals.





Repeat the voltage, overvoltage and current tests given on page 38 for the other output channel(s) using the  key

Changing Resolution Range

1. Press the  key.

2. Observe the selected output's full scale programming range for voltage and current in the front panel display.

3. Press either the  or the  key. (voltage or current)

4. Observe that the selected output's full scale programming range for voltage and current changes to the high range (if the  key is pressed) or low range (if the  key is pressed). Note that no range change will occur if the  or  key is pressed while the supply is already in the requested range.

Introduction To Remote Operation

The following paragraphs explain the fundamentals of operating the supply remotely from a computer. Only a few commonly used programming commands will be discussed. Refer to Chapter 5 for a detailed description of all the commands. The intent of this discussion is to help first time users to quickly become familiar with operating their supply from a computer.

The programming examples that follow assume that a computer is connected to the GP-IB connector on the rear of your supply (see Chapter 2), power is applied, and loads are not connected to any of the supply's outputs. The examples used are primarily for Agilent Series 200/300 computers using Agilent BASIC language. Read the manuals for your particular computer to find out which statements you must use.

Enter/Output Statements

The programming statements you use to operate your supply from remote depend on your computer and its language. In particular, you need to know the statements your computer uses to output and enter information. For example, the Agilent BASIC language statement that addresses the power supply to listen and sends the command to the power supply is:

OUTPUT

The Agilent BASIC language statement that addresses the power supply to talk and reads back data from the power supply is:

ENTER

The supply's front panel ADDR annunciator is on when the supply is addressed to talk or to listen.

Reading the GP-IB Address

Before you can operate your power supply remotely, you need to know its GP-IB address. The address was displayed during the power on sequence described in page 36. To see the address, press:

ADDR

A typical address display is shown in Figure 3-6:

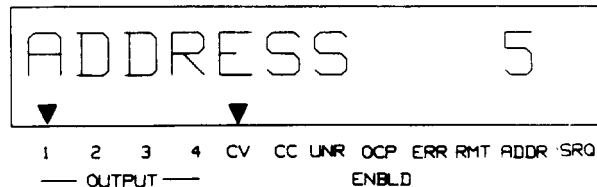

Figure 3-6. Typical Address Display

The displayed response is the power supply's GP-IB address. When sending a remote command, you append this address to the computer's GP-IB interface select code (normally 7). For example, if the select code is 7 and the power supply's GP-IB address is 5, the combination is 705.

Changing the GP-IB Address

Note All examples in this discussion assume a GP-IB address of 5. It is recommended that you retain this address to simplify programming.

Every device on the GP-IB must have an address. The supply's address is factory set to decimal 5. Any address from 0 through 30 is a valid address. If you need to change the Agilent 662xA Supply's address press:

ADDR

You can now enter a new address. For example, press:

1

4

ENTER

You have now changed the address from 5 to 14. If you want to change the address back to 5, repeat the above procedure but use 5 instead of 14 in the last step. Note that the address is stored in the power supply's non-volatile memory and therefore will be retained through interruption of the ac line power.

Sending a Remote Command

To send the power supply a remote command, combine your computer's output statement with the GP-IB interface select code, the GP-IB device address, and finally, the power supply command. For example, to set the output voltage of output channel 1 to 2 volts, send:

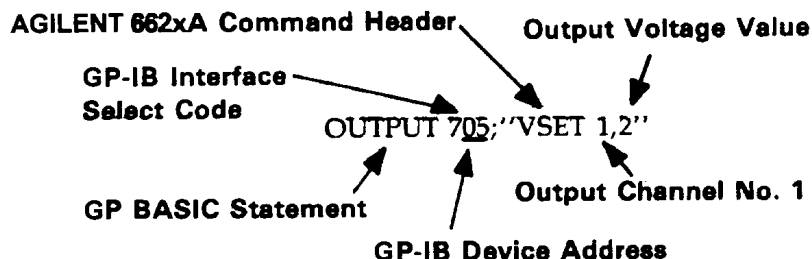

Getting Data From The Supply

The supply is capable of measuring the values of its output parameters in response to queries. In this example, the query asks the supply to measure the output voltage at output 1.

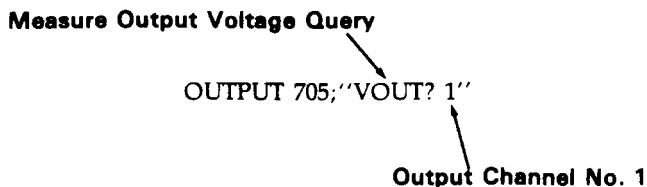

When you send a query from remote, the supply does not display the response as it did when you executed the command from the front panel. Instead, it holds the response in an output buffer. The output buffer is a register that holds information until it is read by the computer or is replaced with new information.

Note On an Agilent Series 200/300 Computer, the A variable must be declared before you do the following steps. Refer to your computer's operating manual for more information.

Use your computer's enter statement to get the response from the output buffer. For example, execute:

```
ENTER 705; A
```

Followed by:

```
DISP A
```

The ENTER statement enters whatever is in the supply's output buffer into the computer's A variable. The DISP statement displays the A variable's contents on the computer's display.

Often Used Commands

The command set contains over sixty commands that allow you to program the power supply in a variety of applications. Within this command set, however, is a small subset of commands that are all you need for most applications. These commands are: VRSET, IRSET, VSET, ISET, VOUT?, IOUT?, OUT, OVSET, and OCP.

Each of these commands is briefly discussed in the following paragraphs to help you get started in programming your supply. To know more about these commands, refer to Chapter 5.

The VRSET and IRSET commands select the range the power supply operates in. Two ranges are available for each output - standard resolution, and high resolution (see Table 1-2).

If the value for voltage or current entered is not within the present operating range of the supply, the error annunciator will indicate an error. Sending ERR?, and addressing the supply to talk, will return the error message (in the case "number range" error would be displayed).

Voltage and Current Programming. You can send voltage and current values to the power supply directly in volts or amps. The following examples use voltage and current values that are within the range of any output that the power supply provides.

To set the voltage of output 1 to 5 volts, send:

```
OUTPUT 705; "VSET 1,5"
```

To set the current of output 2 to 450 milliamps, send:

```
OUTPUT 705; "ISET 2,.450"
```

Output Voltage and Current Measurement. The power supply has built-in metering circuitry, which allows it to monitor the output voltage and current of the selected output. You can instruct the supply to return its present output voltage and current using VOUT? and IOUT? queries respectfully. The metering circuitry is auto-ranging, and will select the proper resolution.

To measure the output voltage at output 1, send:

```
OUTPUT 705; "VOUT? 1"
```

To get the measurement from the output buffer, send:

```
ENTER 705; A
```

```
DISP A
```

The computer should display a reading of approximately 5 volts .

To measure the output current at output 2, send:

```
OUTPUT 705; "IOUT? 2"
```

To get the measurement from the output buffer, send:

```
ENTER 705; A
```

```
DISP A
```

Output On/Off. You can turn a specified output on or off. Individual outputs can be controlled as shown below.

To turn off output 1, send:

OUTPUT 705; "OUT 1,0"

When an output is turned off, it is set to 0 volts and to the minimum current limit value

To turn on output 1, send:

OUTPUT 705; "OUT 1,1"

When an output is turned on it will return to the voltage and current settings determined by the present VSET and ISET values.

Overvoltage Setting. You can send an overvoltage setting value to the power supply directly in volts. If the output voltage exceeds this setting, the output crowbar is fired, and the output voltage is quickly downprogrammed and disabled (0 volts output).

To set the overvoltage value of output 2 to 3.5 volts, send:

OUTPUT 705; "OVSET 2,3.5"

Overcurrent Protection. The output will go to the off state (0 volts and 0 current) when the overcurrent protection (OCP) feature is enabled and the output is in the + CC mode. To enable the overcurrent protection mode for output 2 send:

OUTPUT 705; "OCP 2,1"

To disable the overcurrent protection mode for output 2, send:

OUTPUT 705; "OCP 2,0"

When overcurrent protection is disabled and the output is in + CC mode, the output current will be limited to and will stay at the ISET value.

Returning the Supply to Local Mode

In the remote mode (RMT annunciator on), the front panel keys have no effect on any of the supply's outputs and only the computer can control the supply. However, you can still use the front panel display to monitor the output voltage and current or check any of the present settings (VSET, ISET, OVSET, etc.) of the selected output channel.

If you want to use the front panel keys to change the output settings, you must return the supply to the local mode. You can return the supply to the local mode (provided that the local lockout command has not been received from the computer) by pressing the LCL key. A change between the local and remote modes (or vice versa) will not result in a change in the power supply outputs. Refer to Chapter 6 for additional details on using the LCL key and operating the supply in the local mode.

Output Connections and Operating Information

Introduction

This chapter explains how to make connections to the output terminals located on the rear of your power supply. Some general operating information is included in this chapter to help you understand how the power supply operates under various load conditions. This information applies whether you are operating the supply via the front panel or the GP-IB.

Output Ranges

Figure 4-1 identifies the output combinations that are available on the power supply. Each output can operate as a constant voltage (CV) or constant current (CC) source over a wide variety of output voltage and current combinations. In addition, each output has an active downprogrammer which operates at currents up to approximately 110% of the maximum positive current rating of the output. This means that each output can actively sink as well as source its maximum rated output current. At voltages below 2.5 V, a downprogramming resistor continues downprogramming until the voltage reaches approximately zero volts.

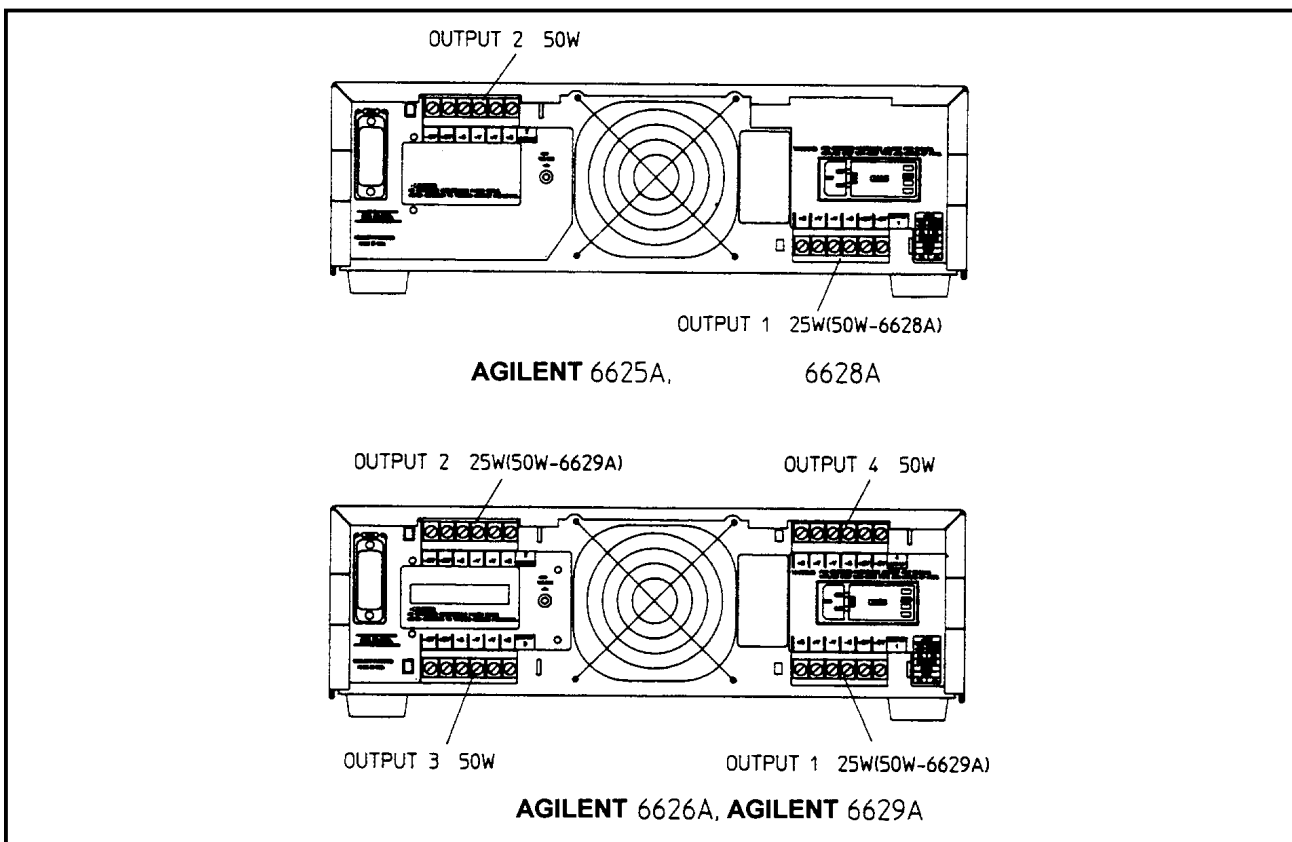

Figure 4-1. Output Combinations

Operating Quadrants

Figures 4-2A and 4-2B show the operating locus of your power supply in three quadrants. The area in quadrant 1 shows the operating locus defined by the voltage and current settings of each output. The area in quadrant 2 indicates the locus where each output can operate as a current sink. You cannot program current limit values in quadrant 2.

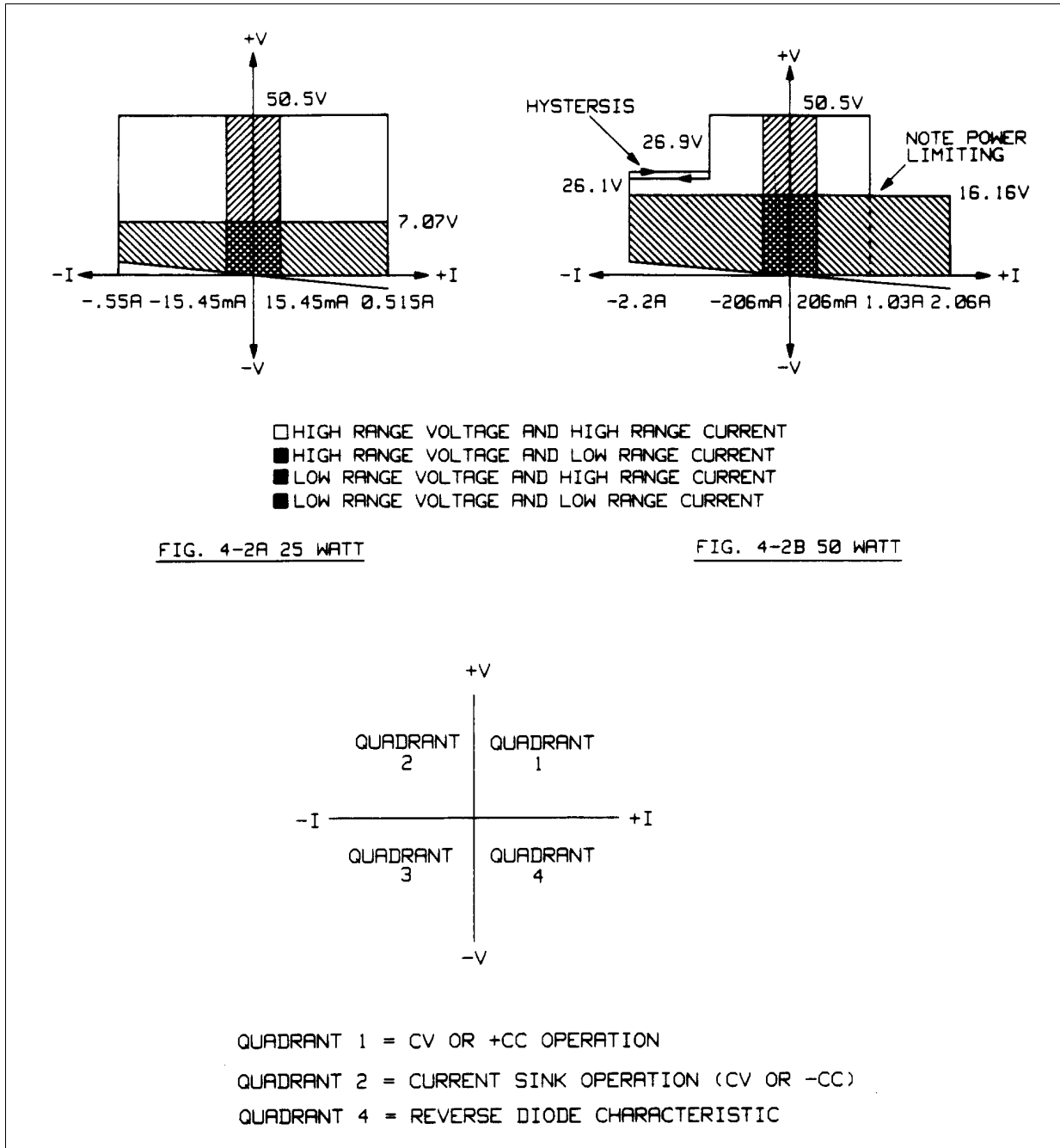

Figure 4-2. Typical Output Range Characteristics

Figure 4-3 shows the current sink characteristics lower voltages in greater detail. The area in quadrant 4 illustrates the reverse polarity diode characteristics of each output. Do not operate any output with reverse-voltage currents that are greater than the maximum rating of the output.

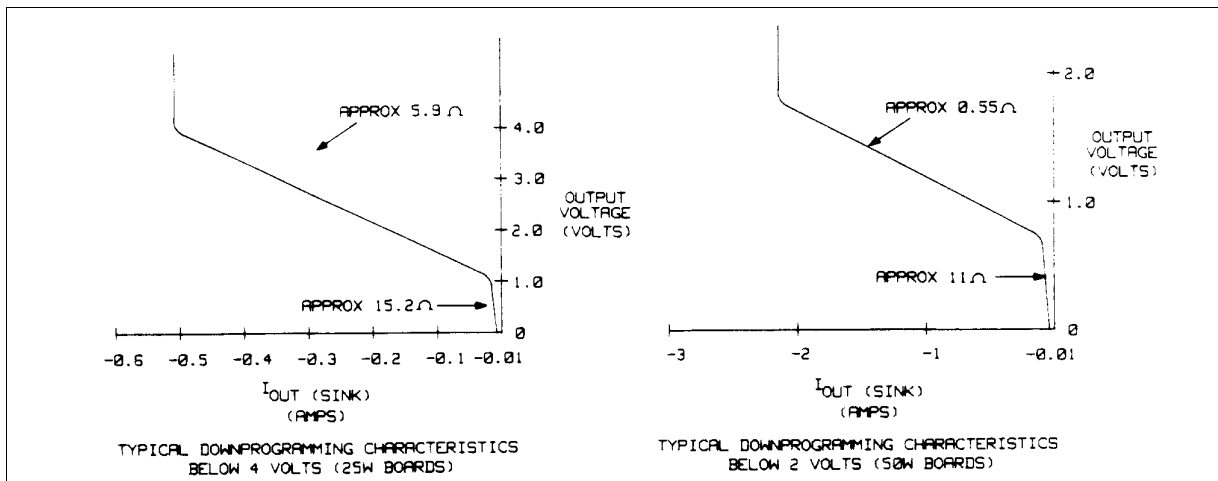

Figure 4-3. Typical Downprogramming Characteristic Below 2.0 V

Operating Ranges

Notice in Figure 4-2, there are four overlapping areas in quadrant one for both the 25 watt and 50 watt outputs. The Low Range Voltage and Low Range Current ranges are higher precision than the High Range Voltage and High Range Current ranges. The voltage and current ranges can be set independently (see page 73). If the high resolution range is programmed, attempting to program values outside this range will result in a number range error.

The 50 watt output (Figure 4-2B) is different from the 25 watt output (Figure 4-2A), in that there is a power limiting boundary at 1 amp in the High Voltage/High Current range. As a result, the 50 watt output can be set to no more than 1.03 amps at voltage settings above 16.16 volts, and vice versa.

Setting parameters of voltage or current beyond this power limit boundary, but within the High Voltage/High Current range will cause the other parameter (voltage or current) to automatically be scaled down to the power limiting boundary (see pages 71 and 73).

The voltage and current programming resolution of the outputs is affected by the setting of the range. The voltage of the 25 watt output, when programmed to the Low Voltage Range, has a voltage programming resolution of 460 μ V. When programmed above 7 volts, the High Voltage Range must be selected resulting in a programming resolution of 3.2 mV.

The current of the 25 watt output, when programmed to the High Current Range, has a current programming resolution of 1 μ A. When programming above 15 mA, the High Current Range must be selected, resulting in a programming resolution of 33 μ A.

The voltage of the 50 watt output, when programmed to the High Voltage Range, has a voltage programming resolution of 1 mV. When programming above 16.16 volts, the high range must be selected, resulting in a programming resolution of 3.2 mV.

The current of the 50 watt output, when programmed to the High Current Range, has a current programming resolution of 13 μ A. When programmed above 200 mA, the High Current Range must be selected, resulting in a programming resolution of 131 μ A.

The readback range of the outputs is not programmable, and is selected automatically by the power supply.

The readback resolution of the 25 watt outputs when metering voltages of 7 volts or below, will be 483 μV . For voltages above 7 volts, the readback resolution will be 3.3 mV.

The readback resolution of the 25 watt outputs when metering source currents of 15 mA or below, the readback resolution will be 1 μA . When metering source currents above 15 mA, the readback resolution will be 48 μA .

When metering sink currents of 15 mA or below, the readback resolution of the 25 watt outputs will be 1 μA . When metering sink currents above 15 mA, the readback resolution will be 37 μA .

When metering voltages of 16 volts, or below, the readback resolution of the 50 watt outputs will be 1.1 μV . For voltages above 16 volts, the readback resolution will be 3.3 mV.

When metering source currents of 200 mA or below, the readback resolution of the 50 watt outputs will be 14 μA . When metering source currents above 200 mA, the readback resolution will be 160 μA .

When metering sink currents of 200 mA or below, the readback resolution of the 50 watt outputs will be 14 μA . When metering sink currents above 200 mA, the readback resolution will be 151 μA .

Protection Features

Protective circuitry within the supply can limit or turn off an output in the event of an abnormal condition. The activated protection feature can be determined by observing the front panel display area. You can also read back the status of the supply over the GP-IB. The following protection features are implemented:

OVERVOLTAGE -- shorts the output by firing an SCR crowbar and sets zero volts and minimal current on an output if any of the following conditions are present:

1. The output voltage exceeds the programmed overvoltage trip point.
or
2. The sum of the voltage from the + V output terminal to the +S terminal plus the voltage from the -S terminal to the -V output terminal exceeds 10.0 V (applies to remote sensing only).
or
3. A trip signal is received on the output's OV terminals.
or
4. The output's fixed overvoltage circuit is activated.

The OV trip point can be programmed up to 55 V. When an overvoltage occurs, the word OVERVOLTAGE appears in the front panel display and the OV status bit is set for that output. Chapter 5 explains how to program the overvoltage trip level.

A fixed overvoltage threshold of approximately 120% of the maximum rated output voltage is built into each output. Because the fixed overvoltage circuit is biased from the output terminals, it can be activated and provide protection even when the supply is not connected to the ac power line.

The OVRST command or front panel RESET key restores the programmed voltage and current values and clears the OV once the cause of the overvoltage has been eliminated.

OVERCURRENT -- when the overcurrent protection feature is enabled, and the output is sourcing current and enters the + CC operating mode, the output will be disabled (set to zero volts and minimal current) and the word OVERCURRENT will appear on the front panel display. In addition, the OC status bit is set for that output. The OCRST command or front panel RESET key restores the programmed voltage and current values and clears the OC once the cause of the overcurrent condition has been eliminated. Refer to Chapter 5 for programming details.

UNREGULATED OUTPUT -- the supply informs the user when output regulation is not guaranteed. This can occur when attempting to sink excessive currents below 4 volts on 25 W outputs and 2 volts on 50 W outputs or when operating outputs in parallel. The UNR annunciator on the front panel and the UNR bit in the status register indicate that the specified output is unregulated. Line voltage dropout or an incorrectly set ac power module can also cause the output to become unregulated. If line voltage dropout continues, the supply shuts down and will return to the power-up condition when normal line voltage is restored.

OVERTEMPERATURE -- shuts down the linear pass transistors and downprogrammer of the output that has reached an unsafe operating temperature. Operation of the other outputs is unaffected. An overtemperature can occur because of excessively high ambient temperature, a blocked fan, or insufficient space at the sides for adequate air circulation. When an overtemperature condition occurs, the word **OVERTEMP** appears in the front panel display and the OT status bit is set. This circuit resets automatically and restores the output approximately 30 seconds after the temperature drops sufficiently for safe operation.

ERROR -- if the power supply receives an invalid command either through the front panel or the GP-IB, the ERR annunciator on the front panel comes on and the ERR bit in the serial poll register is set. The power supply does not execute the command and remains at previously set values. Pushing the ERR button in local mode displays the error message and clears the error. The error indicator may also indicate that an instrument failure has occurred. Refer to Appendix D for further details.

Connecting The Load

Each terminal block cover on the rear panel is secured by a locking tab which snaps into a slot at the left of the terminal block. To remove, insert a screwdriver into this rectangular slot and move the locking tab to the left. When the locking tab releases, gently pull the terminal block cover away from the terminal block. To reinstall the cover, align it over the terminal block and gently press it into position until the locking tab engages.

WARNING

SHOCK HAZARD. Turn off ac power before making rear panel connections. All wires and straps must be properly connected with terminal block screws securely tightened. Replace terminal block covers before reapplying power.

Each rear terminal block has six M3.5 x 0.6 x 6 mm screws for attaching wires (see Figure 2-2). Load connections to the supply are made at the + V and -V terminals on each terminal block. Do not connect unterminated wires to the load terminals. Wires used for load connections must be properly terminated with termination connectors securely attached. Remember to replace the impact resistant plastic covers (Agilent P/N 06624-20007) over the terminal blocks after making connections.

Consistent with good engineering practice, all sense and trigger leads connected to the rear terminal blocks should be twisted and shielded to maintain the instrument's specified performance.

Wire Size Selection

WARNING

FIRE HAZARD Select a wire size large enough to carry short-circuit current without overheating. Two factors must be considered when selecting wire size for load connections: conductor temperature and voltage drop. To satisfy safety requirements, load wires must be heavy enough not to overheat while carrying the short-circuit output current of the unit. Table 4-1 lists the current-carrying capacity (ampacity) for various sizes of stranded wire.

Note that the minimum wire size required to prevent overheating may not be large enough to prevent OV trip when remote sensing and to maintain good regulation. The load wires should be large enough to limit the total voltage drop in both leads to no more than 10 volts. See Figure 4-6 for total allowed load lead drop when programming to high voltage settings. With remote sensing, load regulation is degraded 1 mV per 1 V in the - V output terminal load lead. (See Remote Sense Connections on page 52).

Note

To prevent tripping of the overvoltage circuit, pick a wire size sufficient to handle the FULL output current of the unit no matter what the intended load current or current limit setting.

Table 4-1 lists the resistivity for various wire sizes and the maximum lengths to limit the voltage drop to 1.0 volts for various currents.

Table 4-1. Stranded Copper Wire Ampacity and Maximum Wire Lengths to Limit Load Lead Voltage Drop

Wire Size (AWG)	Ampacity Per Wire (Amps)		Resistivity (Ω /ft)	Max Length to Limit Voltage Drop to 1 V Per Lead		
	2 Wire Bundled	4 Wire Bundled		5 A	10 A (feet)	20 A
20	7.8	6.9	0.0102	20	10	5
18	14.5	12.8	0.0064	30	15	7.5
16	18.2	16.1	0.0040	50	25	12.5
14	29.3	25.9	0.0025	--	40	20
12	37.6	33.2	0.0016	--	--	30
(Cross Section Area in mm ²)			(Ω /m)	(meters)		
0.5	7.8	6.9	0.0401	5	2.4	1.2
0.75	9.4	8.3	0.0267	7.4	3.8	1.8
1	12.7	11.2	0.0200	10	5	2.6
1.5	15.0	13.3	0.0137	14.6	7.2	3.6
2.5	23.5	20.8	0.0082	--	12.2	6

Notes:

1. Ampacities for AWG wires are derived from MIL-W-5088B. Maximum ambient temp: 55°C. Maximum wire temp: 105°C.
2. Ampacities for metric wires are derived from IE Publication 335-1.
3. Ampacity of aluminum wire is approximately 84% of that listed for copper wire.
4. Because of wire inductance considerations, it is recommended that you keep your load leads twisted, tie wrapped, or bundled together and less than 50 feet (14.7 meters) in length per lead.
5. See Page 49 for information on wire gauge considerations with capacitive loads.

Note

The OVP circuit senses at the main output terminals and not on the sense leads. Thus, the voltage sensed by the OVP circuit could be as much as 10 V higher than the voltage being regulated at the load. Program the OVP trip voltage accordingly when using remote sensing. In addition, if the total voltage drop in both leads exceeds 10 V, a protective circuit will fire the OVP circuit regardless of the OVP setting.

Load lead resistance is an important factor relating to the CV stability of the supply with remote sensing of capacitive loads. If high capacitance loads are expected, you should not use wire gauges heavier than 12 to 14 AWG for long runs of load lead. See Figure 1-4 for more information about stability with output capacitors.

Multiple Loads

If you will be sensing the load locally (as shipped from the factory) and are connecting multiple loads to one output, connect each load to the output terminals using separate connecting wires (see Figure 4-4). This minimizes mutual coupling effects and takes full advantage of the power supply's low output impedance. Each pair of wires should be as short as possible and twisted or bundled to reduce lead inductance and noise pickup.

If load considerations require the use of distribution terminals that are located remotely from the supply, connect the power supply output terminals to the remote distribution terminals by a pair of twisted or bundled wires. Connect each load to the distribution terminals separately. Remote voltage sensing is recommended under these circumstances. Sense either at the remote distribution terminals or, if one load is more sensitive than the others, directly at the critical load.

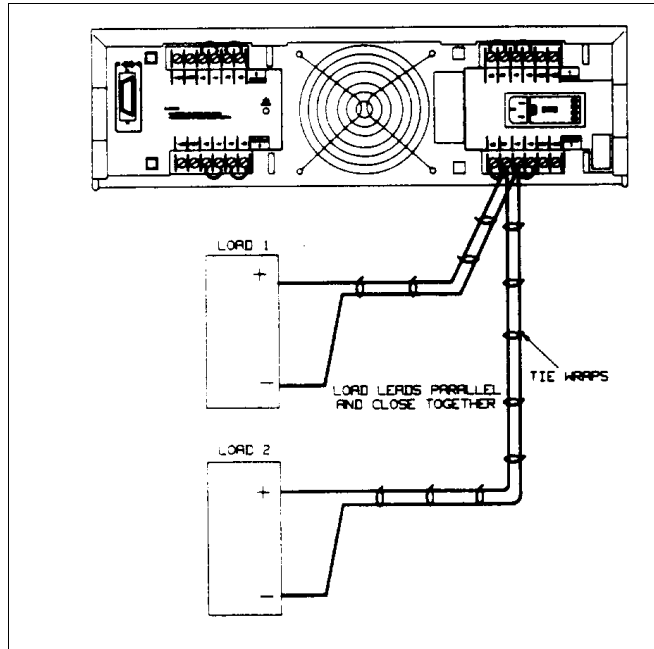

Figure 4-4. Optimum Hookup for Multiple Loads, Local Sensing

Note

When a load is connected through relay or switch contacts, contact bounce may activate the overvoltage circuit and shut down the supply. Therefore, it is recommended that the output be downprogrammed to 0 or turned-off (disabled) before the relay (or switch) contact is opened or closed.

Positive and Negative Voltages

Either positive or negative voltages can be obtained from the supply by grounding (or "commoning") one of the output terminals. Always use two wires to connect the load to the supply regardless of where or how the system is grounded. This supply can be operated with any output terminal ± 240 Vdc (including output voltage) from ground.

Remote Voltage Sensing

The power supplies will allow up to a total load lead drop of 10 V.

Because of the unavoidable voltage drop developed in the load leads, the as-shipped terminal block strapping pattern shown in Figure 4-4 does not provide the best possible voltage regulation at the load. The remote sensing connections shown in Figure 4-5 improve the voltage regulation at the load by monitoring the voltage there instead of at the supply's output terminals. This allows the power supply to automatically compensate for the voltage drop in the load lead. Remote sensing is especially useful for CV operation with load impedances that vary or have significant lead resistance. It has no effect during CC operation. Because sensing is independent of other power supply functions, remote sensing can be used regardless of how the power supply is programmed. Note that with remote sensing, voltage readback monitors the load voltage at the sense points.

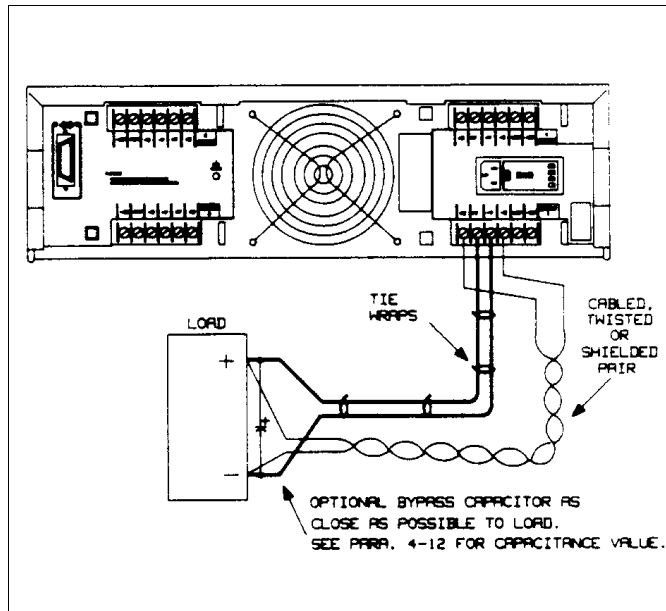

Figure 4-5. Remote Voltage Sensing

The maximum voltage available at the power supply output terminals during remote sensing (see Figure 4-6) is 50.5 volts. This allows the sum of the voltage across both load leads to equal 10 volts maximum. For lower output voltages refer to Figure 4-3.

Remote Sense Connections

Remember to turn off the power supply before making or changing any connections on the rear panel terminal blocks. Connect the unit for remote sensing by first disconnecting the straps between sense and load terminals. Then make your connections as shown in Figure 4-5. Connect the sense leads as close to the load as possible. See wire size selection (pages 49 - 50) for information on selection of load lead wire gauge. Best results will be obtained by using the shortest load leads practical. It is recommended that you keep your load leads under 14.7 meters (50 feet) per lead because of inductance effects.

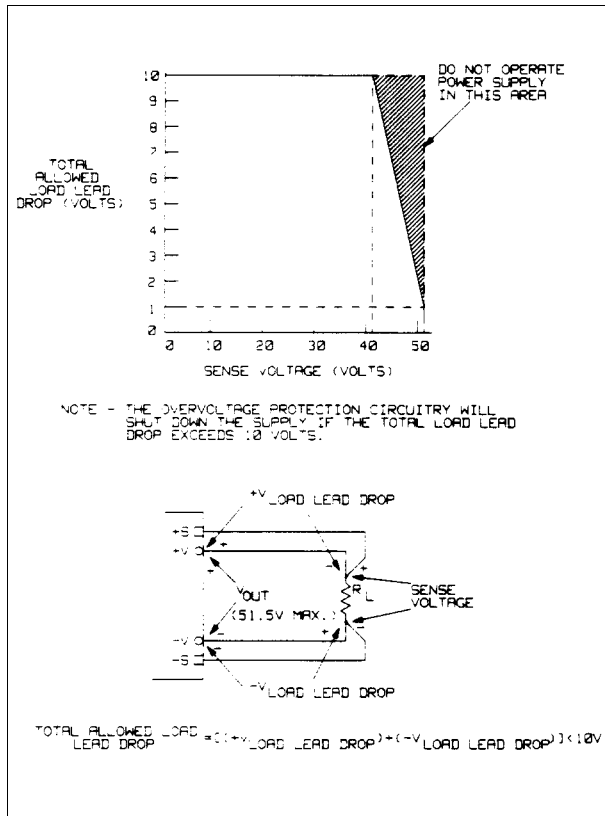

Figure 4-6. Total Allowable Load Lead Voltage Drop (total of both leads) with Remote Sensing

Output Noise Considerations

Any noise picked up on the sense leads will appear at the supply's output and may adversely affect CV load regulation. Twist the sense leads or use a ribbon cable to minimize the pickup of external noise. In extremely noisy environments it may be necessary to shield the sense leads. Ground the shield at the power supply end only; do not use the shield as one of the sensing conductors.

The noise specifications in Table 1-2 apply at the power supply output terminals when using local sensing. However, voltage transients may be produced at the load by noise induced in the leads or by load current transients acting on the inductance and resistance of the load lead. If it is desirable to keep voltage transient levels to a minimum, place an aluminum or a tantalum capacitor, with an approximate value of 10 μF per foot (30.5 cm) of load lead, right across the load (see Figure 4-5). Refer to Figure 1-4 for capacitive load stability considerations.

Programming Response Time with an Output Capacitor

Because voltage programming into an external output capacitor may cause the supply to briefly enter CC operating mode, voltage programming response time may be longer than that specified in Table 1-2. Use the following formula to estimate the additional response time:

$$\text{Additional Response Time} = \frac{(\text{Added Output Capacitor})(\text{Charge in Vout})}{\text{Current Limit Setting}}$$

Open Sense Leads

The sense leads are part of the supply's feedback path. Connect them in such a way so that they do not inadvertently become open circuited. The power supply includes protection resistors that reduce the effect of open sense leads during remote-sensing operation. If the sense leads open during operation, the supply returns to the local sensing mode, with the voltage at the output terminals approximately equal to the programmed value.

Overvoltage Trigger Connections

Each output of your power supply has two OV terminals on its rear panel terminal block. These terminals are labeled +OV and -OV. By connecting the OV terminals all in parallel as shown in Figure 4-7, an overvoltage shutdown on any one output will also trigger the overvoltage on the remaining outputs. Any number of OV terminals up to eight sets can be strapped together. Observe polarity when connecting the OV terminals in parallel.

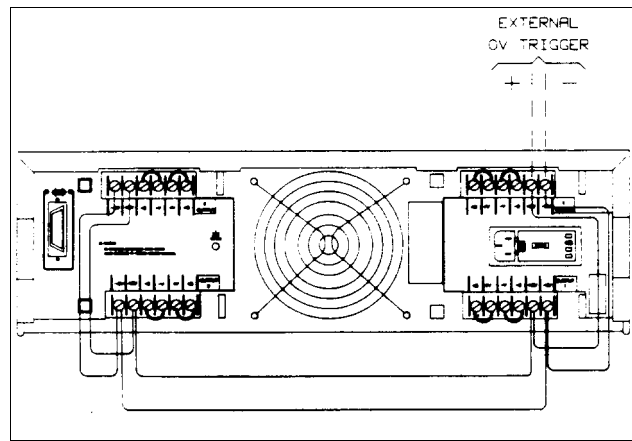

Figure 4-7 Overvoltage Connections

The overvoltage trip point for each output can be set either from the front panel or by remote programming. You can also externally fire the overvoltage circuit of one or more outputs by applying a 5 volt pulse of at least 50 μ s to any pair of OV terminals (see Figure 4-8). As long as all OV terminals are wired together, the outputs will be crowbarred simultaneously.

External Trigger Circuit

Figure 4-8 illustrates a recommended external circuit that can be used to provide an OV trip signal to the OV terminals. This circuit configuration provides good noise immunity and protects against the voltage pulse that is returned from the OV terminals every time that the overvoltage circuit fires. It can be operated from a wide range of bias voltages provided the input limiting resistors are chosen as tabulated in the figure. If it is not required to trip the OV with a TTL signal, then a bias supply, switch, current limiting resistor (R2), and protection diode are all that are required. Note that with the unit off (ac power removed), the + OV and - OV terminals are inactive.

The internal equivalent OV circuit is shown in Figure 4-9. Note the internal DC blocking capacitor, bleed resistor, and noise bypass capacitors.



Do not exceed 50 volts maximum between the + OV and the - OV terminals. The OV terminals are rated at ± 240 Vdc (including external OV voltage) from chassis ground or any other output terminals.

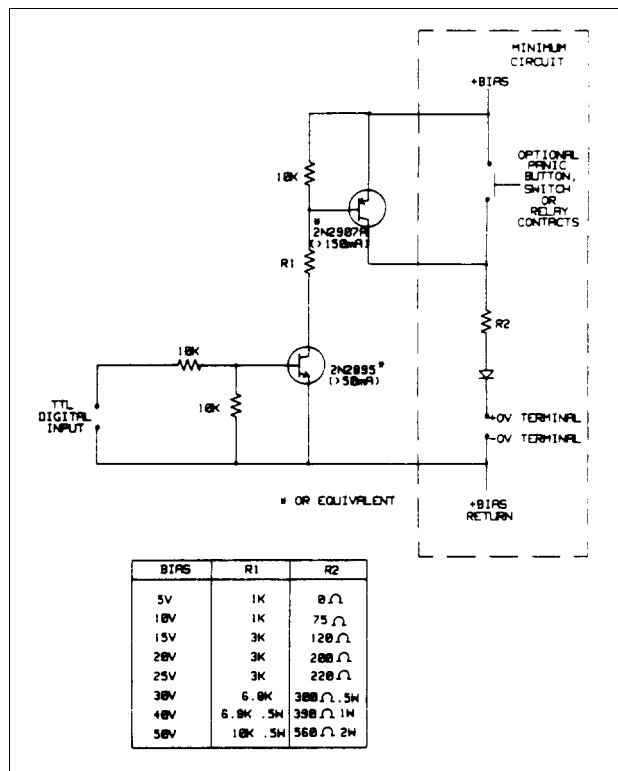

Figure 4-8. External Trigger Circuit

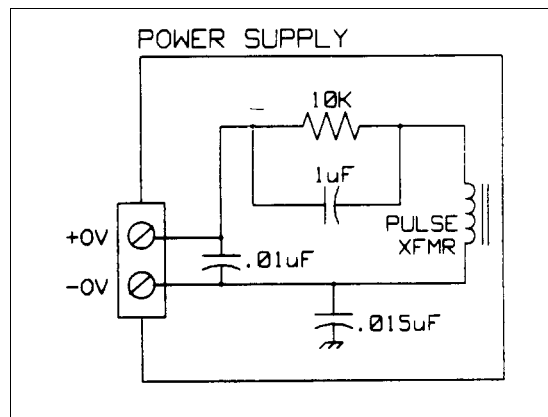

Figure 4-9. Equivalent Internal OV Trigger Circuit

Power Supply Protection Considerations

Battery Charging

If you are using your supply in a battery charging application, it is recommended that a series protection diode be added to prevent damage to the supply during an overvoltage shutdown. Remember that each output has an overvoltage protection circuit that fires a crowbar to disable the output for any of the OVERVOLTAGE conditions described on page 48.

Figure 4-10 illustrates the recommended connections and protection circuit for a battery charging application. The diode will prevent damage to your supply that can result from excessive battery current flowing into the supply's output in the event of an overvoltage shutdown.

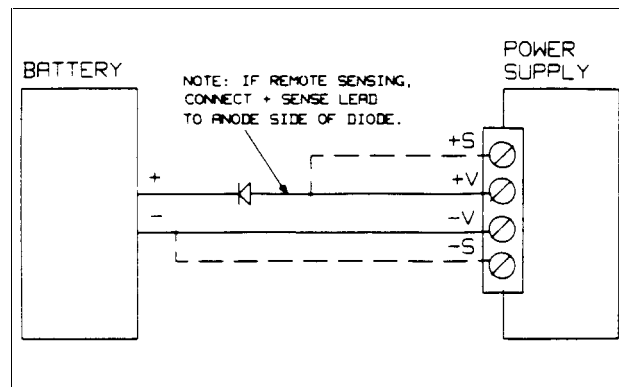

Figure 4-10. Recommended Protection Circuit for Battery Charging

Capacitive Load Limitation

The programmable overvoltage protection circuit can be used to downprogram capacitive loads although it is primarily intended for use as a protection feature as described on page 48.

CAUTION

Repetitive (over 100 cycles) tripping of the overvoltage circuit with output capacitors greater than 2000 μF may result in eventual damage to the supply.

Parallel Operation

CAUTION

Connect in parallel only outputs that have equivalent voltage and current ratings.

Connecting outputs in parallel provides a greater current capability than can be obtained from a single output. Because each output contains an active downprogrammer that is capable of sinking current from only ONE identical output, you can parallel no more than two outputs. These outputs must have equivalent voltage and current capability. For example, on the Agilent 6626A power supply, only outputs 1 and 2 or 3 and 4 may be connected together. On the Agilent 6625A supply, none of the outputs may be connected together. If you are mixing different model supplies (i.e. an Agilent 6625A and an Agilent 6626A) be sure to connect only equivalent voltage and current outputs in parallel.

As an example, Figure 4-11 shows how to connect two outputs in parallel to a single load with local sensing. This configuration applies to both CV and CC operating modes. Connecting the load leads of output 2 directly to the + V and - V terminals of output 1 keeps the total length of the load leads to a minimum and reduces the number of wire connections that must be made at the load itself. Connecting the + S and -S terminals of output 2 directly to the sense terminals of output 1 compensates for the IR drop in the interconnecting load leads.

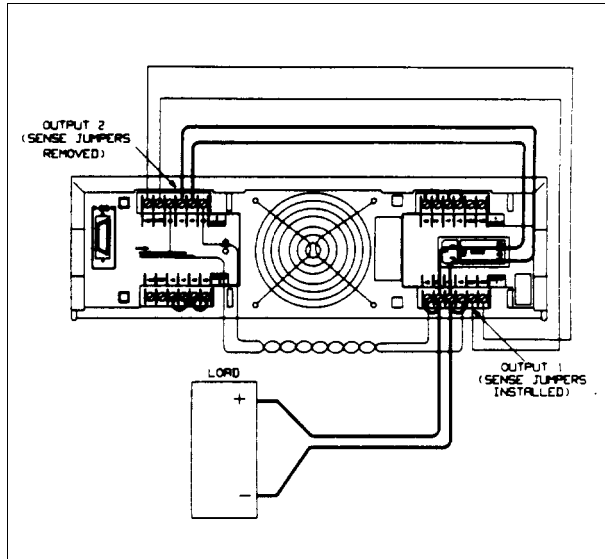

Figure 4-11. Parallel Connections with Local Sensing

CV Operation

For CV operation, one output must operate in CC mode and the other output must operate in CV mode. Although each output operates independently of the other, the output that is operating in CV mode will be "controlling" the voltage regulation of both outputs. Setting the output voltages as outlined in the following paragraph and configuring the outputs as shown in Figure 4-11 will allow output 1 to operate in CV mode and output 2 to operate in CC mode.

To assure that output 2 will be operating in CC mode, you must program output 2's voltage to a higher value than the voltage of output 1. One way to accomplish this is to first program output 2 to the maximum allowable voltage setting for the desired operating range (see Table 4-2 or Figure 4-2). These values are 1% higher than the rated voltage for the operating range. Then, program output 1's voltage to the desired operating voltage. The lower voltage setting of output 1 will determine the voltage that appears across the load. The current limit point of the paralleled outputs is the sum of both individual current limit points. The output current of the parallel combination is the algebraic sum of the individual current readbacks.

The + OV and - OV terminals of output 1 should be wired to the + OV and - OV terminals of output 2. When programming the overvoltage setpoint, set both outputs to the same overvoltage value. When resetting the overvoltage, first disable both outputs by using the OUTPUT ON/OFF key or OUT command. Next, reset both overvoltages. Finally, re-enable the outputs with the OUTPUT ON/OFF key or OUT command.

Table 4-2. Maximum Allowable Voltage Setting

Output Type	Maximum Low Range Voltage	Maximum High Range Voltage
25W	7.07V	50.5V
50W	16.16V	50.5V

Note

Below 4 V on 25 W outputs and 2 V on 50 W outputs, the downprogrammer cannot sink the maximum rated current. (See Figures 4-2 and 4-3). To operate parallel outputs at voltages under 2.5 V, program both outputs to the same voltage setting. Depending on the load, one output may operate in the unregulated mode.

CC Operation

For CC operation, set the output voltages as outlined in CV operation (page 57), or alternatively, program the voltage settings of both outputs to the same voltage limit point. Then program the current of each output so that the sum of both currents equals the total desired operating current. The simplest way to accomplish this is to program each output to one half of the total desired operating current. Both outputs will operate in the CC mode.

Remote Sensing

If it is necessary to remote voltage sense at the load, parallel the sense leads of output 1 with the sense leads of output 2 and connect to the load as shown in Figure 4-12. The outputs can be programmed as previously described.

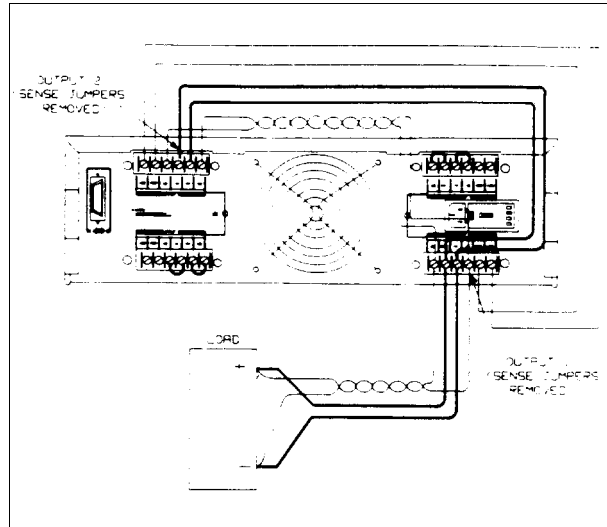

Figure 4-12. Parallel Connections with Remote Sensing

Specifications for Parallel Operation

Specifications for outputs operating in parallel can be obtained from the specifications for single outputs. Most specifications are expressed as a constant or as a percentage (or ppm) plus a constant. For parallel operation, the percentage portion remains unchanged while constant portions or any constants are changed as indicated below.

Current	All parallel specifications referring to current are twice the single output specification except for programming resolution which is the same for both single output and parallel output operation.
Voltage	All parallel specifications referring to voltage are the same as for a single output except for CV load effect, CV load cross regulation, CV source effect, and CV short term drift. Below 4 V on 25 W outputs and 2 V on 50 W outputs, these are all twice the voltage programming accuracy (including the percentage portion). CV load effect above 4 V on 25 W outputs and 2 V on 50 W outputs, could be twice the load effect specification for a single output. CV output noise for output voltages less than 4 V on 25 W outputs, and 2 V on 50 W outputs, may be slightly higher than the output noise for a single output.
Load Transient Recovery Time	350 μ s maximum to recover within 100 mV of nominal value following a load change within the range of 0 to full load.

Series Operation

WARNING

SHOCK HAZARD. Floating voltages must not exceed 240 Vdc. No output terminal may be more than 240 Vdc from chassis ground.

CAUTION

Connect in series only outputs that have equivalent current ratings. Each output has a reverse voltage protection diode across its output terminals. The current conducted by this diode is not internally limited by the output. Therefore, never connect an output in such a way that this diode will conduct current in excess of the rated current of the output since damage could result.

Connecting outputs in series provides a greater voltage capability than can be obtained from a single output. Because the current is the same through each element in a series circuit, outputs connected in series must have equivalent current ratings. Otherwise, the higher rated output could potentially damage the lower rated output by forcing excessive current through it under certain load conditions.

Figure 4-13 shows an example of how to connect two outputs in series to a single load with local sensing. This configuration applies to both CV and CC operating modes. Connecting the + load lead of output 2 directly to the - V terminal of output 1 completes the series connection between the two outputs. Connecting the + S terminal of output 2 directly to the - S terminal of output 1 and removing the sense jumper (between + S and + V) on output 2 compensates for the IR drop in the load lead from output 2 to output 1.

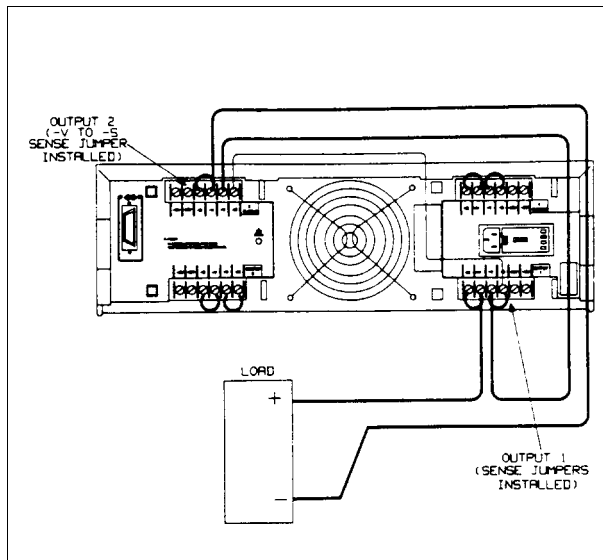

Figure 4-13. Series Connections with Local Sensing

CV Operation

For CV operation, first program the current setting of each output to the desired current limit point. Then program the voltage of each output so that the sum of both voltages equals the total desired operating voltage. The simplest way to accomplish this is to program each output to one half of the total desired operating voltage. Both outputs will operate in CV mode.

CC Operation

For CC operation, the current setting of each output must be programmed to the desired operating current. The sum of the voltage settings determines the voltage limit point. As an example, one way to program the voltage of the output is to set the voltage of each output to one half of the total voltage limit point. Then, at load voltages less than one half of the total voltage limit point, one output will operate in CC mode while the other output will be conducting through its internal reverse voltage protection diode. At load voltages greater than one half the total voltage limit point, the output that was in CC mode will change to CV mode while the output that was conducting through its diode will regulate the current in CC mode and provide the balance of the voltage required by the load. Note that the total load voltage can be found by adding the results of reading back the individual series outputs only when neither reverse voltage protection diode is conducting. When this diode is conducting, the corresponding output has reverse voltage across it so that its voltage readback may not be accurate.

When an output is conducting through its reverse voltage protection diode, the output will have a reverse voltage across its output terminals with the - V terminal more positive than the + V terminal. This voltage will be maximum at the rated current of the output. (See Figure 4-2 for reverse diode characteristic). Note that when an output conducts through this diode, it will indicate CC mode even though it is not regulating the current or voltage. Also, note that the voltage readback is not specified to indicate negative voltages although it will operate down to a limit of about - 0.176 V on the 25 W outputs and -0.392 V on the 50 W outputs. These values will still be indicated even if the actual voltage is more negative.

Remote Sensing

If it is necessary to remote voltage sense at the load, connect the sense leads of output 1 and output 2 as shown in Figure 4-14. Note that the + sense lead of output 2 must remain connected to the -sense terminal of output 1. The outputs may be set as previously described.

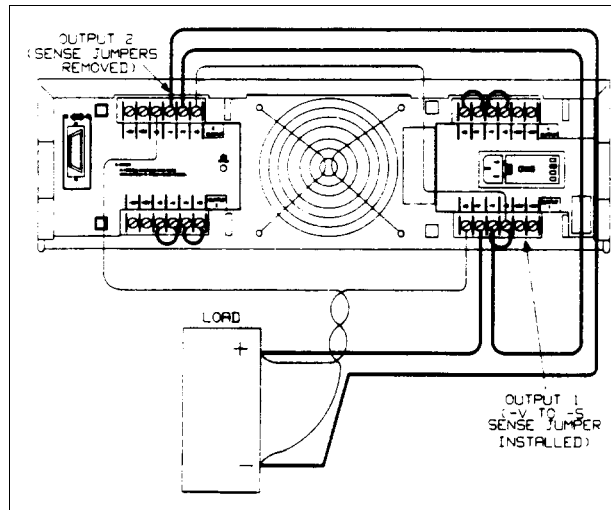

Figure 4-14 Series Connections with Remote Sensing

Specifications for Series Operation

Specifications for outputs operating in series can be obtained from the specifications for single outputs. Most specifications are expressed as a constant or a percentage (or ppm) plus a constant. For series operation, the percentage portion remains unchanged while constant portions or any constants are changed as indicated below.

Voltage	All series specifications referring to voltage are twice the single output specification except for programming resolution which is the same as for a single output.
Current	All series specifications referring to current are the same as for a single output except for CC load effect, CC load cross regulation, CC source effect, and CC short term drift which are twice the current programming accuracy (including the percentage portion).
Load Transient Recovery Time	Load transient recovery time is the same to within approximately twice the voltage setting band since the output impedances of the series combination add together.

Bi-Polar Operation

Figure 4-15 shows an example connecting the outputs of the power supply for bi-polar operation to test power FET's (PFET).

Great flexibility is achieved with this setup. The outputs of the power supply can be programmed as voltage or current sources providing positive or negative voltages or currents. By taking measurements via internal readback circuitry in the power supply, the outputs can be used as voltmeters or ammeters.

In order to properly measure the parameters of the PFET, it is desirable to be able to directly regulate any two of the bias parameters of the PFET, while being able to measure a third. The setup shown in Figure 4-15 allows control of V_{ds} and I_{ds} while measuring V_{gs} .

In this example, outputs 3 and 4 are connected to allow bipolar operation. Notice that the - S and - V leads, of outputs 3 and 4, are strapped together. The + S lead of V3 senses the voltage at the drain of the Device Under Test (DUT) and the + S lead of output 4 senses the voltage at the source of the DUT. Outputs 1 and 2 are strapped to sense the gate to source voltage.

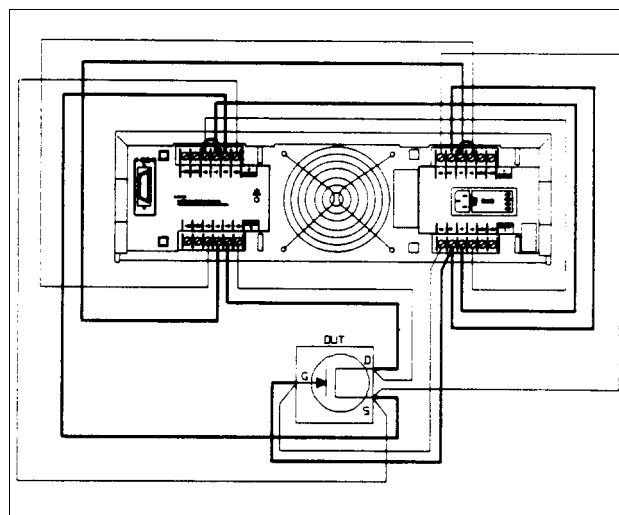

Figure 4-15. Bipolar Operation

Remote Operation

Introduction

Chapter 3 introduced you to the basics of remote operation and provided a few simple examples using a Series 200/300 computer as the GP-IB controller. This chapter contains all the information required to control your power supply remotely and discusses in greater detail how each of the commands can be implemented. The material covered is intended for any controller capable of using the GP-IB interface functions mentioned in Interface Functions on page 63.

Four major sub-sections are discussed. These are:

1. GP-IB Operation
2. Programming Syntax
3. Initial Conditions
4. Power Supply Commands

The GP-IB section briefly describes the GP-IB interface functions to get you acquainted with remote programming using the GP-IB. Under Programming Syntax, the syntax of all commands, the numeric data formats and the programmable ranges for all models are given. Initial Conditions highlights the initial values of all the parameters at power-on. Power Supply Commands will describe all the commands which can be used to program the supply's functions including status reporting, error handling, protection features, and voltage and current programming. The power supply commands are summarized in Appendix C.

The examples are written in a generic form to make adaptation to your controller easy. You should be familiar with the use of your controller and its instruction set and how the power supply commands can be incorporated in your controller commands. If you are not familiar with the operation of the power supply, you are advised to read through Chapters 2 through 4 first.

GP-IB Operation

Interface Functions

Remote control is implemented by the GP-IB. It enables instructions to be sent from an external computer equipped with a GP-IB interface. The power supply implements the following IEEE-488 Interface Functions:

SH1 - Source Handshake	SR1 - Service Request
AH1- Acceptor Handshake	RL1 - Remote/Local
T6 - Talker	RL1 - Parallel Poll
L4 - Listener	DC1 - Device Clear

The source handshake, acceptor handshake, talker and listener functions are implemented by the interface circuits of the power supply and the controller. The ADDR annunciator indicates when the power supply is addressed to listen or talk. (The talker function includes the Serial Poll, see page 64).

Service Request. This is a message which can be initiated by the power supply to request service from the controller. When the supply is requesting service, it asserts the service request (SRQ) line on the GP-IB to interrupt the controller providing the controller is configured to service interrupts. A service request can be generated whenever there is a fault on one of the outputs (up to 4 outputs), a programming error has occurred, or at power on providing certain commands are sent. Service request commands are discussed in detail in Service Request Generation on page 79.

The SRQ annunciator on the front panel display is turned on when the power supply is requesting service from the computer and remains on until the controller conducts a serial poll. A serial poll removes the service request and turns off

the SRQ annunciator regardless of whether the condition that caused the service request continues to exist. The service request is also removed when you send the "CLR" command (see page 76).

Remote/Local. The power supply can receive programming information either from the GP-IB (remote) or from the front panel (local). When the power supply is in remote, the state of the supply cannot be changed by using the front panel keys, although the LCL key will remain enabled. Remote operation takes precedence over local operation, hence if the supply is accepting commands remotely and you attempt to change it to local operation, the supply will not allow any local settings and will remain in remote. You can prevent the front panel from sending programming information by sending the local lockout command. This command is sent only from the GP-IB. If you change from local to remote or vice-versa, there will be no change in the programmed settings.

Parallel Poll. Parallel Poll allows the controller to receive at the same time one bit of data from each of up to eight instruments connected to the bus. Agilent power supplies designate bit #6, the RQS bit of the serial poll register for this operation. By checking the status of this bit, the computer can quickly determine which instruments on the bus requested service. Once an instrument is identified, the computer can perform a serial poll to find out the exact cause of the request. Parallel Poll does not reset this service request bit (RQS) in the power supply.

Note IEEE-488 does not define what data an instrument should put on a bus in response to parallel poll. Many instruments such as Agilent Technologies power supplies indicate the state of their RQS bit, but the operator should not assume that all instruments on the bus respond to parallel poll with their RQS bit.

Unless remotely configured, the power supply will respond with a 1 on one of the GP-IB data lines if it is requesting service and its address is between 0 and 7. Addresses 0 through 7 define which data line (1 through 8) the supply will respond on. If the address is set to 8 or greater, the supply will not respond unless remotely configured.

The power supply may be remotely configured to respond with a 0 or 1, on any of the data lines, to indicate that it is requesting service. This is done in accordance with IEEE-488 1978.

Serial Poll. In a serial poll, the controller polls each instrument on the bus one at a time. The power supply responds by placing the contents of the eight-bit serial poll register on the GP-IB data lines. The Serial Poll register is discussed on page 78 and defines the function of each of the bits. After the serial poll, the service request is cleared and the SRQ annunciator at the front panel is reset (off). However, the condition that generated the service request may still be present. See page 79.

Device Clear. The Device clear command is typically used in systems to send all devices in the system to a known state with a single command. It may be implemented as an addressed or an unaddressed command. The power supply CLR command performs the same function as Device Clear (see page 76).

GP-IB Address Selection

You can find out the present address or change the address of the supply by using the front panel ADDR key as described in Chapter 3. Any address 0 through 30 is a valid address. If you program an address outside this range you will get a number range error.

Note Care should be taken to not select the controller address.

Power-On Service Request (PON)

The power supply can request service from the controller when the power is turned on. This request can be enabled or disabled by sending a PON command (see page 80). When the request is enabled, the supply can generate an SRQ at power-on or when there is a momentary loss in power. You can execute a serial poll to clear the service request. Table 5-7 details the conditions under which a PON command will generate an SRQ.

Note The power supply has a non-volatile memory in which it stores certain system variables. Some of these variables are the calibration constants, the present supply address, and the present setting of the PON command.

Programming Syntax

The following paragraphs describe the syntax of the device command that is used to program your power supply. As shown in Figure 5-1, the device command is a specific part of the program statement that your computer will accept. The first part of the statement is computer as well as programming language specific. Figure 5-1 shows the structure of a typical programming statement for an Agilent Series 200/300 computer. If you are using a different computer or programming language, refer to your computer programming manual to determine the correct syntax for this portion of the program statement. This section of the manual is only concerned with the device command portion (the part inside the quotes for Series 200/300 computers with BASIC) of the program statement.

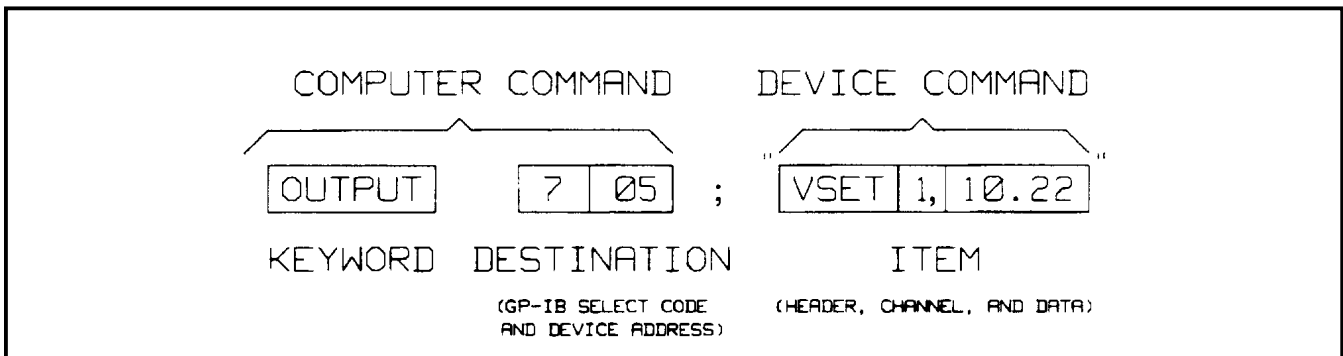

Figure 5-1. Typical Program Statement for Series 200 Computers

Table 5-1. Power Supply Commands

Command	Header	Output Channel	Data Range (Fig. 5-2)	Syntax
Query accumulated status register	ASTS?	1, 2, 3, 4	---	Q2
Return power supply to turn on state	CLR	---	---	C1
Turn calibration mode on or off	CMODE	---	0,1 (OFF,ON)	C2
Query if calibration mode is on	CMODE?	1, 2, 3, 4	See Table 5-4	Q1
Set the state of outputs at power on	DCPON	---	0,1 (OFF, ON) CC+ 2,3 (OFF, ON) CC-	
Query outputs power on state	DCPON?	---	---	
Set the reprogramming delay time	DLY	1, 2, 3, 4	0-32	C4
Query the setting of the delay time	DLY?	1, 2, 3, 4	---	Q2
Turn front panel display on or off	DSP	---	0,1(OFF,ON)	C2
Display a string on front panel	DSP	---	"STRING"	C6
Query if front panel display is on	DSP?	---	---	Q1

Table 5-1. Power Supply Commands (continued)

Command	Header	Output Channel	Data Range (Fig. 5-2)	Syntax
Query present hardware error	ERR?	---	See Table 5-8	Q1
Query fault register	FAULT?	1, 2, 3, 4	---	Q2
Query the model number of supply	ID?	---	---	Q1
Program the I DAC in counts	IDAC	1, 2, 3, 4	See Service Manual	C4
Query setting of I DAC in counts	IDAC?	1, 2, 3, 4	---	Q2
Send data to calibrate I circuits	IDATA	1, 2, 3, 4	See Table 5-4	C5
Sets output to high I cal. value	IHI	1, 2, 3, 4	See Table 5-4	C3
Sets output to low I cal. value	ILO	1, 2, 3, 4	See Table 5-4	C3
Query measured I output	IOUT?	1, 2, 3, 4	See Table 5-4	Q2
Used to Calibrate I readback circuits	IRDAT	1, 2, 3, 4	See Table 5-4	C5
Set output to + I readback high cal value	IRHI	1, 2, 3, 4	See Table 5-4	C3
Set output to - I readback high cal value	IRHN	1, 2, 3, 4	See Table 5-4	C3
Set output to - I readback low cal value	IRLN	1, 2, 3, 4	See Table 5-4	C3
Set output to + I readback low cal value	IRLO	1, 2, 3, 4	See Table 5-4	C3
Set full scale current range of output	IRSET	1, 2, 3, 4	See Table 5-4	C4
Query full scale current range	ISET?	1, 2, 3, 4	See Table 5-4	Q2
Set current of an output	ISET	1, 2, 3, 4	See Table 5-4	C4
Query current of an output	ISET?	1, 2, 3, 4	See Table 5-4	Q2
Increase or decrease output current by value	ISTEP	1, 2, 3, 4	See Table 5-4	C4
Select which output will be metered	METER	---	1-4	C2
Query which output is being metered	METER?	---	---	Q1
Send data to calibrate -I readback	NIDAT	1, 2, 3, 4	See Table 5-4	C5
Enable overcurrent protection	OCP	1, 2, 3, 4	0,1 (OFF,ON)	C4
Query if OCP is enabled	OCP?	1, 2, 3, 4	---	Q2
Reset overcurrent protection	OCRST	1, 2, 3, 4	---	C3
Turn output on or off	OUT	1, 2, 3, 4	0,1 (OFF,ON)	C4
Query if output is on or off	OUT?	1, 2, 3, 4	---	Q2
Perform overvoltage calibration	OVCAL	1, 2, 3, 4	See Table 5-4	C3
Reset overvoltage circuit	OVRST	1, 2, 3, 4	---	C3
Set overvoltage trip value	OVSET	1, 2, 3, 4	See Table 5-4	C4
Query overvoltage trip value	OVSET?	1, 2, 3, 4	See Table 5-4	Q2
Enable power on service request	PON	---	0,1 (OFF,ON)	C2
Query if PON is enabled	PON?	1, 2, 3, 4	---	Q1
Recall voltage and current settings	RCL	---	0-10	C2
Set readback DAC to a number of counts	RDAC	1, 2, 3, 4	See Service Manual	C4
Query readback DAC count setting	RDAC?	1, 2, 3, 4	---	Q2
Query revision date of ROM	ROM?	---	---	Q1
Query revision date of secondary ROM	SRQM?	1, 2, 3, 4	---	Q2
Set causes for generating a service request	SRQ	---	01,2,3	C2
Query causes which will generate an SRQ	SRQ?	---	---	Q1

Table 5-1. Power Supply Commands (continued)

Command	Header	Output Channel	Data Range (Fig. 5-2)	Syntax
Store present output state	STO		0-10	C2
Query preset status of output	STS?	1, 2, 3, 4		Q2
Perform self test on GP-IB interface	TEST?		.	C1
Set bits in mask register	UNMASK	1, 2, 3, 4	0-255	C4
Query bits set in mask register	UNMASK?	1, 2, 3, 4		Q2
Program the voltage DAC in counts	VDAC	1, 2, 3, 4	See Service Manual	C4
Query setting of voltage DAC in counts	VDAC?	1, 2, 3, 4		Q2
Send data to calibrate the voltage circuits	VDATA	1, 2, 3, 4	See Table 5-4	C5
Set output to high V calibration value	VHI	1, 2, 3, 4	See Table 5-4	C3
Set output to low V calibration value	VLO	1, 2, 3, 4	See Table 5-4 V	C3
Query inputs of analog multiplexer	VMUX?	1, 2, 3, 4	1-18	C4
Query measured value of an output	VOUT?	1, 2, 3, 4	See Table 5-4	Q2
Calibrate the voltage readback circuitry	VRDAT	1, 2, 3, 4	See Table 5-4	C5
Set output to V readback high cal value	VRHI	1, 2, 3, 4	See Table 5-4	C3
Set output to V readback low cal value	VRLO	1, 2, 3, 4	See Table 5-4	C3
Set full scale voltage programming range	VRSET	1, 2, 3, 4	See Table 5-4	C4
Query full scale voltage programming range	VRSET?	1, 2, 3, 4	See Table 5-4	Q2
Set output voltage	VSET	1, 2, 3, 4	See Table 5-4	Q2
Query setting of output voltage	VSET?	1, 2, 3, 4	See Table 5-4	Q2
Increase or decrease output voltage by value	VSTEP	1, 2, 3, 4	See Table 5-4	C4

Figure 5-2 shows the possible syntax forms for the device commands that are used to program the power supply. Syntax forms for the calibration commands that are discussed in Appendix A are also included. The oblong shape at the left of the syntax forms contains the command header which must be entered as shown in Tables 5-1 and 5-2. Commands are accepted in either uppercase or lowercase letters (ASCII characters). Circles contain characters that must be entered exactly as shown. Characters such as a space <SP> or a comma are used to separate elements in the command string. Characters such as a line feed <LF> or a semicolon are used to terminate the command string. Rectangles contain parameters that follow the command header lines and arrows indicate the correct paths through the syntax diagrams.

Numeric Data

The power supply will accept numeric data in implicit point, explicit point, or scientific notation. A general syntax diagram for numeric data is included in Figure 5-2. Implicit point notation means that numbers do not contain a decimal point; integers for example. Numbers written in explicit notation contain a decimal point, such as 12.35. In scientific notation, the letter E stands for "10 raised to". For example, 1.2E3 is read as 1.2 times 10 raised to the 3rd power, which equals 1,200. Plus and minus signs are considered numeric characters and are optional. If you program a number with an accuracy that is greater than the resolution of the supply, the number will automatically be rounded to the nearest multiple of the power supply's resolution. Table 5-1 gives the ranges for numeric data that is sent to the supply.

The power supply will also return numeric data (ASCII characters) to your computer. The format of the numbers returned depends upon the type of data requested. Table 5-2 gives the format for data returned to the computer in response to any of the queries that are listed.

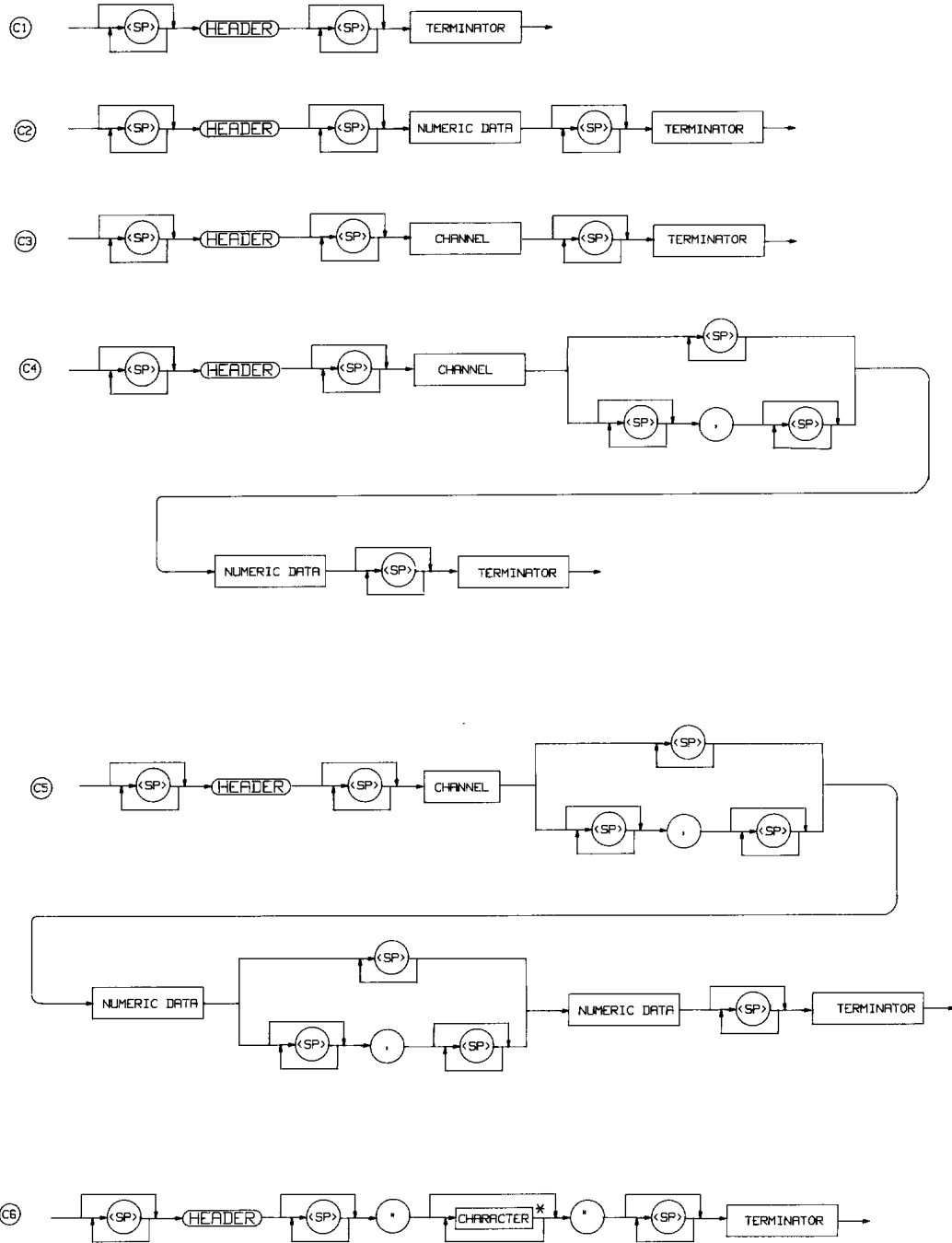

Figure 5-2 (Sheet 1 of 2). Syntax Forms For Power Supply Commands

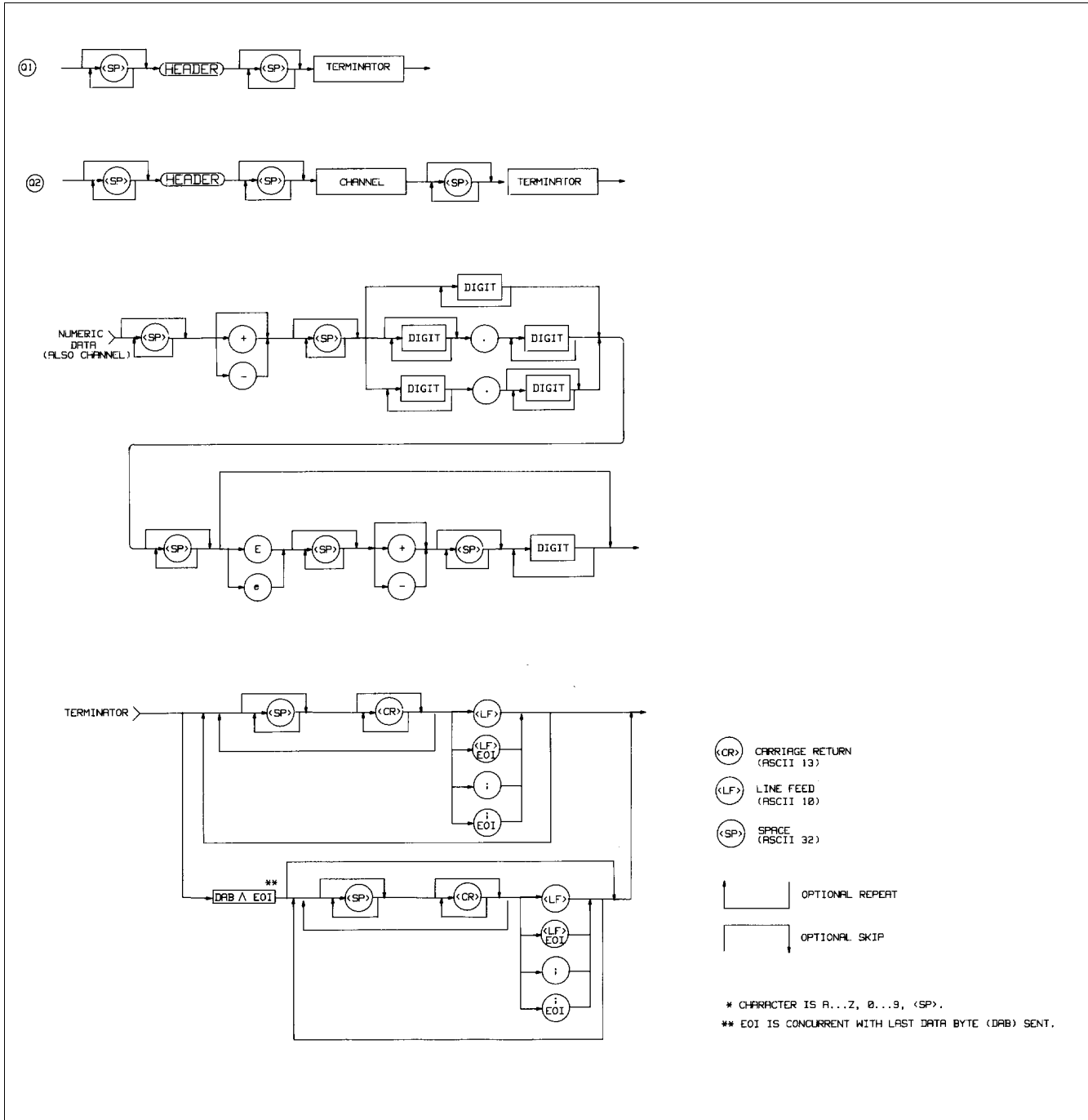

Figure 5-2 (Sheet 2 of 2). Syntax Forms For Power Supply Commands

Table 5-2. Power Supply Queries

Query	Header (Note 7)	Channel (Note 1)	Response (Notes 5 and 6)	Initial Value	Syntax (Fig. 5-2)
Voltage Setting	VSET?	1,2,3,4	SZD.DDD(Note 3)	0(Note 8)	Q2
Current Setting	ISET?	1,2,3,4	(Note 2)	10 mA (Note 8)	Q2
Full Scale Current Range	IRSET?	1,2,3,4	(Note 2)	High (Note 8)	Q2
Full Scale Voltage Range	VRSET?	1,2,3,4	ZD.DDD (Note 8)	High (Note 8)	Q2
Voltage Output	VOUT?	1,2,3,4	SZD.DDD (Note 3)	--	Q2
Current Output	IOUT?	1,2,3,4	(Note 2)	--	Q2
OVP Setting	OVSET?	1,2,3,4	SZZD.DD	55 V (Note 8)	Q2
OC Protection On/Off	OCP?	1,2,3,4	ZZD	--	Q2
Output On/Off	OUT?	1,2,3,4	ZZD	--	Q2
Unmask Setting	UNMASK?	1,2,3,4	ZZD	0 (Note 8)	Q2
Delay Setting	DLY?	1,2,3,4	<sp>ZD.DDD	.02 (Note 8)	Q2
Status	STS?	1,2,3,4	ZZD	--	Q2
Accumulated Status	ASTS?	1,2,3,4	ZD	--	Q2
Fault	FAULT?	1,2,3,4	ZZD	--	Q2
Error	ERR?	--	ZZD	--	Q1
Service Request Setting	SRQ?	--	ZZD	0 (OFF)	Q1
Power-On SRQ On/Off	PON?	--	ZZD	0 (OFF) (Note 9)	Q1
Display On/Off	DSP?	--	ZZD	1 (ON)	Q1
Model Number	ID?	--	Agilent 662XA (Note 4)	--	Q1
Selftest	TEST?	--	ZZD	--	Q1
Calibration Mode	CMODE?	--	ZZD	0 (OFF)	Q1
DC Power On	DCPON?	--	ZZD	1 (ON) (Note 9)	Q1

S = Sign Z = Digit with leading zeros put out as spaces D = Digit < sp > = space

NOTES:

1. Output channels 3 and 4 are not used in all modes. (See Table 5-4).
2. Current is SZD.DDDDD (0.5 A) & SZD.DDDDD (15 mA) SZD.DDDD(2 A) & SZD.DDDDD (0.2 A)
3. Voltage can be SZD.DDDD on 7 VR
4. "X" depends upon model.
5. A space is returned for a + sign.
6. All responses are followed by a <CR> and <LF> (EOI asserted with <LF>).
7. Spaces are allowed between the header and the question mark.
8. Unit powers up with values in state register 0. Table 5-3 gives initial factory settings.
9. Factory setting. Powers up to last stored value.

Order of Execution

When you send a set of instructions to the power supply, they are executed in the order in which they are received. The power supply completes the execution of the present command before executing another command. To send more than one command within the power supply command string, use a semicolon to separate the commands. This maximizes the rate at which the power supply accepts commands.

Terminators

Terminators mark the end of a command string. As shown in Figure 5-2, the semicolon, line feed < LF >, and carriage return line feed < CR > < LF > are the characters that indicate the end of a message to the power supply. When you are using the Agilent Series 200 computer with BASIC to send a command using the standard format (see Figure 5-1), the computer automatically sends < CR > < LF > on the data bus following the command.

Initial Conditions

Immediately after power on from the factory, the power supply automatically undergoes a self-test and sets all parameters to the values contained in Table 5-3. The values in the first part of the table come from storage register 0 and were stored at the factory. They will remain until STO 0 is used to change settings of the power on state. When the power supply is again turned on, it will initialize its outputs to the values in storage register 0.

Table 5-3. Initial Conditions

Parameter	Initial Value
Voltage	0 V High Range
Current	10 mA High Range
Reprogramming Delay	20 mS
Store/Recall registers:	
0-10: Voltage	0 V High Range
Current	10 mA High Range
Over Voltage (OV)	55 V (High Range)
Over Current Protection (OCP)	Disabled
UNMASK register	0 (cleared)
SRQ	0 (Off)
Output Channels	On
Front Panel Metering	Output #1
Power Supply Address	Last stored value (Factory set to 5)
Local Control	Enabled
PON bit	On
PON SRQ	Off (0)
Cal Mode	Off

Power Supply Commands

This section discusses the commands which you will use to program the supply's voltage and current, protection circuits, and enhanced features like storage and recall registers, and reprogramming delay. When programming, you should be aware that the current, voltage and overvoltage ranges for each output of your supply may differ. Table 5-1 shows these values for the power supply. If you send values out of these ranges, you will get a number range error. A summary of all commands appears in Appendix C.

WARNING

The output voltage of some output channels exceeds the safe operating limit of 42.2 V. To avoid any electrical shock, program the voltage to zero volts or turn off ac input power before changing any rear panel connections. Make certain all straps are properly connected, terminal block screws are securely tightened and terminal block covers are replaced before reapplying power.

Voltage Programming

To program voltage, send the output channel and the programmed value. In the example below, output 1 is programmed to 5 V.

VSET 1,5

The values you send must always be volts. For example if you want to program 450 millivolts, convert to volts and then send the command:

VSET 1,.45

If the output channel is operating in constant voltage mode (CV annunciator on) then the actual voltage is the programmed voltage, but in CC mode of operation (CC annunciator on), the programmed voltage is the voltage limit for that output.

When programming a value of voltage, the current setpoint will be changed if the total power is greater than the power boundary (see Figure 4-2).

Example: ISET 4,1.5 sets current to 1.5 A
VSET 4,50 sets voltage to 50 V

Sending the VSET command caused the current ISET to be reduced to 1.03 A. This is an example of power limiting changing a supply setting. When this occurs, the "couple parameter" bit (see Table 5-5) in the status register is set.

Table 5-4. Programmable Output Range

Model		Operating Range *	Output Volt (Avg. Res.)	Output Curr ** (Avg. Res.)
Output Configuration				
6625A / 6628A	6626A / 6629A			
OUTPUT	OUTPUTS	Low	0-7 V (0.460 mV)	0-15 mA (1 µA)
1	1 & 2	High	0-50 V (3.2 mV)	0-0.5 A (33 µA)
OUTPUT	OUTPUTS	Low	0-16 V (1.0 mV)	0.2 A (13 µA)
2 (1,2-6628A)	3-4 1,2,3,4-6629A)	High	0-50 V (3.2 mV)	0-2 A (131 µA)
* The maximum programmable voltage values for each range are 1% higher than the rated voltage and the maximum programmable current values for each range are 3% higher than the rated current.				
** Each channel wakes up to values stored in state register 0. The factory set values are shown in the first part of Table 5-3. All other registers are set to these settings. Volatile registers 4-10 always power-up to these conditions.				

To readback the programmed voltage setting for output 1, send the query:

VSET? 1

and address the supply to talk. If you want to know the value of the actual output voltage of output 1, send the query:

VOUT? 1

The results are placed on the GP-IB and read into the controller when the supply is addressed to talk.

Note The power supply will round the VSET and ISET settings to the nearest multiple of their resolution. Table 5-4 lists the average resolution of these settings.

Current Programming

To program the current, send the output channel and the programmed value in amps. In the example below, output 1 is programmed to 15 mA.

```
ISET 1,0.015
```

The value you send must always be in amps. For example if you want to program 95 milliamps, convert to amps and then send the command

```
ISET 1,.095
```

If the output channel is in constant current (CC) mode of operation, then the actual current is the programmed current but if the output is in the CV mode, the programmed current is the current limit of that output.

When programming a value of current, the voltage set point can be changed if the total power is greater then the power boundary (see Figure 4-2).

Example: VSET 4,50 Voltage set to 50 V
 ISET 4,2 ISET to 2 A

Sending the ISET command caused the VSET to be reduced to 16.16 V. This is an example where power limiting changes a supply setting. When this occurs, the "coupled parameter" bit (see Table 5-5) in the status register is set.

To readback the programmed current for output 1, send the query and addressing the supply to talk.

```
ISET?
```

You can also instruct the supply to measure the actual output current at output channel 1 by sending the following query and address the supply to talk.

```
IOUT? 1
```

The results are placed on the GP-IB and read into the controller.

Range Programming

The range can be set by using the VRSET or IRSET commands. The power supply will automatically pick the range that the value sent will fit into.

Examples: VRSET 1,7 will select the 7 V range
 VRSET 1,3.2 will select the 7 V range
 VRSET 1,9.0 will select the 50 V range
 VRSET 1,50.5 will select the 50 V range
 IRSET 1,.015 will select the 15 mA range
 IRSET 1,0 will select the 15 mA range
 IRSET 1,.020 will select the 0.5 A range
 IRSET 1,0.1 will select the 0.5 A range

Note Ranges will accept values up to 1% greater then full scale for voltage and 3 % for current. Larger numbers will generate a number range error(s).

When going from the high range to the low range, the present setting must be within the boundary of the low range or the setting will be reduced to the maximum of the low range. If the setting is changed the "couple parameter" bit (see Table 5-5) in the status register will be set to indicate the change.

Output On/Off

The OUT command disables/enables an output channel of the power supply. It will not disturb any other programmed function nor will it reset the protection circuits. You can control individual outputs with the OUT command as shown below. For example, to disable output channel 1 send the following:

OUT 1,0

To enable output channel 1 send the following command

OUT 1,1

You can find out the present state of output 1 by sending the query:

OUT? 1

and addressing the supply to talk. The response from the supply is either a "0" to indicate output 1 is off or a "1" to indicate that the output is on. When disabled, the output behaves as if it were programmed to zero volts on the high voltage range and 10 mA on the high current range.

Overvoltage (OV) Protection

The programmable OV is a protection feature which can be set by the operator to protect the load against excessive voltage. When the actual voltage exceeds the programmed overvoltage setting for a given output channel, the OV is tripped. The OV circuit will fire the SCR crowbar which shorts across the output and the output assumes a low impedance state.

For example, to program the OV of output channel 1 to 9.5 V send the following command:

OVSET 1,9.5

To find out the OV setting for output channel 1 send the following query and address the supply to talk:

OVSET? 1

To enable an output after it went into overvoltage, you must first remove the overvoltage condition and then send the OV reset command.

To reset output 1 send:

OVRST 1

If you send the reset command without first removing the OV condition, the supply will fire the OV again.

Note

If the programmable OV fails, the supply has a fixed OV circuit which will fire the SCR crowbar if the voltage exceeds 120% of the maximum rated output. The fixed OV circuit will also fire the SCR crowbar if the supply is off (line cord disconnected) and an external source is supplying voltage which exceeds 120% of the maximum rated output.

Overcurrent Protection (OCP)

The OCP is a protection feature employed by the power supply to guard against excessive output currents. When the output enters the + CC mode and the OCP is enabled, the OCP circuit down programs the output voltage and disables the output.

To enable the OCP, for output channel 1, send the command

OCP 1,1

To disable the OCP, send the command

OCP 1,0

You can find out the OCP setting by sending the following query and addressing the power supply to talk.

OCP? 1

The response from the power supply is either a "0" to indicate that OCP is off or a "1" to indicate that it is on. To reset the output channel after an overcurrent trip, you can either disable the OCP and send the reset command, or you can reduce the output current below the programmed current and then send the reset command. To reset output 1, send the command:

OCRST 1

Note

The supply can report a fault condition when an output is in overvoltage or overcurrent. Although the OVRST and OCRST commands re-enable the output, they do not clear the fault register. As a housekeeping measure, it is advisable to always clear the fault register by querying its value after an OV or OC reset.

Multiple Output Storage & Recall

The power supply has 11 internal registers (0-10) each of which can store the voltage and current settings of all the outputs. By storing voltage, voltage range, current, current range and OV settings for all outputs and recalling them later, you can have significant savings in programming time. (See Supplemental Characteristics in Table 1-2). Upon shipment from the factory, registers (1-10) contain values of 0 volts and 0 current (see Table 5-4).

Registers 0-3 are non-volatile. They are limited to one STORE each. If more than one STORE is attempted, error 30 (STORE LIMIT) will result. The line must be turned off/on to re-enable these store locations. Register 0 is a special case that also contains Delay, Mask. When the power supply is turned on, it will access register 0 for power-up settings. Registers 4-10 (volatile) will be reinitialized to 0 volts and 10 mA (max OV & V, I ranges = HIGH) when power is cycled on/off.

To store voltage and current settings, issue the store (STO) command and specify a register (0-10). For example, to store the present setting of current and voltage of all outputs in register 2, send the following command:

STO 2

To set the power supply to the voltage, voltage range, current, current range, and overvoltage settings stored in a register, issue the recall (RCL) command followed by the desired register. For example to recall settings stored in register 2, send the following command:

RCL 2

When a register is recalled, the outputs will be set sequentially (output 1, output 2, etc.). If you attempt to recall a register outside the 0 to 10 range, you will get a number range error (GP-IB code 5 in Table 5-8).

The Clear Command

This command will return the power supply to its power-on state and all parameters are returned to their initial power-on values except for the following:

1. The store/recall registers are not cleared.
2. The power supply remains addressed to listen.
3. The PON bit in the serial poll register is cleared

To clear the power supply, send the following command:

CLR

Status Reporting

The power supply has the ability to report its internal status to the user whenever it is asked to do so. Depending on the type of status the user requested, the supply will interrogate the status, accumulated status, mask, or fault registers present in each output. The status register can report status independently (see page 76) or it can work together with the mask and fault registers to report a fault (see page 77). The accumulated status register records every status condition the output experienced since the time it was last read (see page 77). Figure 5-3 shows a conceptual model of the operation of these registers.

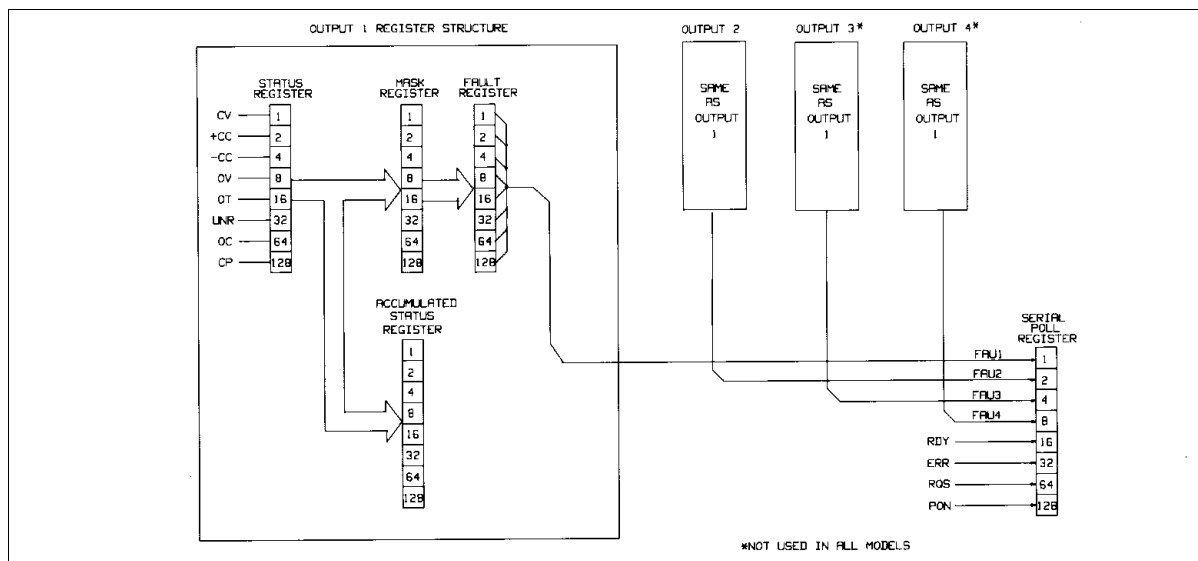

Figure 5-3. Functional Relationship of Status Registers

The supply has one serial poll register which services all outputs and provides the user with other power supply status-related information as discussed in page 78.

Status Register. Each output channel of the power supply maintains its present status in an eight bit register. This status register reports the status of the output channel whenever it is queried. A "1" in any of the bit positions indicates that the condition is true. As long as the condition continues to be true, the bit will remain set. Assignments for the bits are shown in Table 5-5.

Decoding of the reading is based on the weighted number placed on each bit of the eight bit status registers. For example, bit position 5 in the register has a bit weight of 32 (see Table 5-5). Each bit is assigned to a particular condition and the corresponding bit weight is used to identify that condition. When set, bit 5 indicates that the associated output is in the unregulated state. If this is the only bit that is set, the number 32 will be returned when the output's status register is queried.

Table 5-5. Bit Assignment for the Status, Astatus, Fault, and Mask Registers

Bit Position	7	6	5	4	3	2	1	0
Bit Weight	128	64	32	16	8	4	2	1
Meaning	CP	OC	UNR	OT	OV	-CC	+CC	CV
Where								
CV =	Constant Voltage Mode							
+ CC =	Positive Constant Current Mode							
- CC =	Negative Current Limit Mode							
OV =	Overvoltage Protection circuit tripped							
OT =	Over Temperature Protection circuit tripped							
UNR =	Unregulated Mode							
OC =	Over Current Protection tripped							
CP =	Coupled parameter (See Note)							
<p>Note: When the range is switched as discussed on page 73, or the power limit is exceeded (see pages 71 & 73), the CP bit is set. It is cleared when you send a voltage, current or range value that causes no other changes.</p>								

To query an output channel for its status, you must specify the output channel. For example, to find out the status at output 2 send the following query and address the supply to talk:

STS? 2

Accumulated Status Register. Each output channel of the power supply also maintains a cumulative status in its accumulated status (astatus) register. This register records every status condition the power supply output entered since it was last queried. When queried, it returns a decimal number which is decoded as shown below. The astatus register is reset to the present value of the status register after it is queried. The bits are assigned as in Table 5-5. Here is an example to help you decode the decimal number (from 0 to 255) returned when the astatus register is queried. If the output channel was in overvoltage since the last reading of the astatus register and that channel is presently operating in constant voltage mode, the reading you will get when you query the register will be 9. To decode this we use Table 5-5.

$$9 = 8 + 1$$

$$OV + CV$$

For example, to query the astatus register of output 2, send the following query and address the supply to talk

ASTS? 2

The Mask and Fault Register. The fault register works in conjunction with the mask register. These are two eight bit registers which report any fault condition on a particular output channel. The mask register is used to set up the conditions that generate a fault which is latched into the fault register. The user can then read the fault register to determine the fault. When a bit in the fault register is set, the power supply can generate a service request for that output providing the service request command on fault (SRQ 1 or SRQ 3) was previously sent. See page 79 for a discussion on service request.

To understand how these two registers work, we must include the status register in this discussion. Recall that the status register takes its input from the power supply and the user cannot change its contents. The mask register takes its inputs from the user, and the power supply cannot change its contents. The fault register takes its inputs from both the mask and the status registers. You can find out the setting of the mask register of output 2 by sending the following query and addressing the supply to talk:

UNMASK? 2

The response will be a numeric code between 0 and 255 which can be decoded by consulting Table 5-5. You can set the conditions to generate a fault by setting (unmasking) one or more bits in the mask register. The conditions will remain unmasked until you change them. To unmask conditions in output 2 for example, send the following command:

UNMASK 2,XXX

where XXX specifies the numeric code (0 to 255) for the unmasked conditions (see Table 5-5). If during operation, the output experiences any of the previously unmasked conditions, it will set the corresponding bit(s) in its fault register.

Remember that the bits in the fault register can be set when there is a change in either the status register or the mask register. Each output has its status, mask, and fault registers arranged as shown in Figure 5-3 and Table 5-5. The mask register, which is set by the user, is used to specify which bits in the status register are enabled (unmasked) to set bits in the fault register. A bit is set in the fault register when the corresponding bit in the status register changes from "0" to "1" and the corresponding bit in the mask register is a "1". Also, if a bit in the status register is already set and then the corresponding bit in the mask register is set (unmasked), the corresponding bit in the fault register will be set.

In addition, if both status and mask register bits remain set after the fault register was read (and cleared), the fault register will remain cleared as long as there are no changes in either the status or mask registers with the following exception. Executing a VSET, ISET, RCL, OVRST, OCRST, or OUT on/off command, will cause the CV, + CC, - CC, or UNR bit (as applicable) in the fault register to be set. Note that the fault register is cleared immediately after it is read.

As shown in Figure 5-3, if one or more bits in the fault register of a given output channel are set, then the FAU bit for that output in the serial poll register will also be set and a service request may be generated (see page 79). To read the fault register of output 2 and find out which bits are set, send the following query and address the supply to talk:

FAULT? 2

The power supply responds with a number which can be decoded from Table 5-5. For example, the number 9 (8 + 1) indicates that the OV and the CV bits in the fault register are set.

Note If the condition(s) generating the fault(s) is (are) removed but the fault register is not read, the bit(s) in the fault register will remain set.

The Serial Poll Register. The serial poll register is an 8 bit register which the supply uses to keep track of its internal operating status and to determine the operating status of each of its outputs. Table 5-6 defines each bit.

Table 5-6. Bit assignment of the Serial Poll Register

Bit Position	7	6	5	4	3	2	1	0
Bit Weight	128	64	32	16	8	4	2	1
Meaning	PON	RQS	ERR	RDY	FAU 4	FAU 3	FAU 2	FAU 1

The first four bits (0 to 3) in the register tell whether or not a particular output has a fault. If there is a fault in one of the outputs, then the corresponding FAU bit will be set. Thus if output 1 has a fault, then FAU 1 will be set. In models with only three outputs, FAU 4 will always be zero and in two output models, FAU 3 and FAU 4 will always be zero.

The RDY bit is set when processing is complete and is cleared when the supply is processing commands.

The ERR bit is set when a programming or hardware error occurs and is cleared when the error query (ERR?) is received. The error annunciator on the front panel informs the user when this bit is set or cleared.

The RQS bit is set when the power supply generates a service request and cleared after a serial poll is done (see page 79).

The PON bit is set at power on and cleared when a CLR command is sent.

Service Request Generation

When operating your supply, you may want it to request service every time a fault or a programming error condition occurs. To do this you send a service request (SRQ) command. When the condition is true, the power supply responds by setting the RQS bit in the serial poll register, setting the SRQ annunciator on the front panel, and issuing an SRQ over the GP-IB.

The power supply can generate a service request for any of the following reasons: (refer to Table 5-7)

- **An Output Fault.** If there is a fault on one or more of the output channels and you previously sent the SRQ 1 or SRQ 3 command (see Service Request Enable/Disable information below), then an SRQ will be generated.
- **An Error.** If there is an error (see Tables 5-8) and you previously sent the SRQ 2 or SRQ 3 command, (see Service Request Enable/Disable information below), then the supply will generate a service request.
- **Power-on.** At power-on, the PON bit of the serial poll register is set but the supply will only generate an SRQ if you previously sent a PON 1 command.
- **Input Line Voltage Dropout.** Same as power-on condition.

To find out the nature of the service request, you must do a serial poll. This will isolate the output that generated the request by checking which of the FAU bits are set in the case of a fault, or checking to see if the error bit is set in the case of an error. If the SRQ on faults was set, then send the fault query.

FAULT? 2 (using output 2 as an example)

and address the supply to talk if you want to find out which of the conditions you unmasked in Figure 5-3 are true. For example if the supply was in overvoltage and that condition was unmasked then the response from the fault query will be "8" (see Table 5-5).

Note	When you query the fault, the fault register is cleared. Performing a serial poll will reset the RQS bit but will not clear the fault register.
-------------	---

If the SRQ on error was set then you can send the error query ERR? and address the supply to talk. The response will identify the error by its code (see Table 5-8).

Service Request Enable/Disable. You can query the status of the service request enable/disable function by sending the query:

SRQ?

and addressing the power supply to talk. The response from the supply is one of the following:

0, 1, 2, or 3

0--indicates that the service request capability (except for power-on; see page 80) is disabled.

1--indicates that it is enabled for output fault conditions.

2--indicates that it is enabled for error conditions.

3--indicates that it is enabled for both fault and error conditions.

The ability to generate service requests can be enabled or disabled using the SRQ command as described below.

To disable the service request capability, except for power-on, send:

SRQ 0

To enable the service request capability for all output faults, send:

SRQ 1

To enable the service request capability for errors, send:

SRQ 2

To enable the service request capability for both faults and errors, send:

SRQ 3

The Power-On Service Request. You can also cause the power supply to request service every time it is switched on or every time there is a temporary loss in power. To do this send the following command:

PON 1

If you want to disable this facility, send the command.

PON 0

If you want to find out if the power-on SRQ is enabled or disabled, send the following query:

PON?

and address the supply to talk. The supply will respond with a 1 or 0 as discussed above.

Note The power-on (PON) SRQ mode is stored in the non-volatile memory of the supply so that although the supply may be switched off, it will remember the status of the last PON command at power-on and respond accordingly.

Table 5-7 summarizes all the conditions under which a service request will be generated.

Table 5-7. Conditions for Generating a Service Request

Condition	Commands Sent		State of RQS Bit
	PON	SRQ	
• Any	0	0	0
• Power-on	1	-	1
• Error	-	2 or 3	1
• Fault	-	1 or 3	1

Reprogramming Delay

The power supply may switch modes or become unregulated momentarily after a new output value is programmed. Because of their short duration, these cases may not ordinarily be considered a fault but the supply will recognize this deviation and generate a fault signal. To prevent this, the reprogramming delay feature is implemented.

Reprogramming delay will delay the onset of certain fault conditions and prevent the power supply from registering a fault when these conditions are true. When the delay is in effect, the CV, + CC, - CC and UNR bits of the status register are masked and cannot communicate with the mask and fault registers and the OCP function. This will prevent the supply from registering a fault should any of these bits become set during the delay period. Reprogramming delay is initiated when any of the following functions are executed:

VSET, ISET, RCL, OVRST, OCRST, OUT on/off

At power-on reprogramming delay is set to 20 mS. You can specify new values between 0 and 32 S in steps of 4 mS. If you specify a value which is not a multiple of 4 mS, the supply will round off the set value to the nearest 4 mS multiple.

To program a new value of 80 mS in output 2 for example, send the following:

DLY 2,.08

If you send a value outside the 0 to 32 S range you will get a programming error. You may use the programming response times in the specifications table to give you an idea of a typical delay setting. However, the appropriate delay setting will also depend on load capacitance, load resistance, and current limit setting. See page 53 for output capacitor considerations.

To query the reprogramming delay setting of a particular output channel, send the following query:

DLY? 2 (using output 2 as an example)

and address the supply to talk. The response will be a numeric value between 0 and 32.

Display On/Off

When the display is on, the commands sent across the GP-IB may experience a slower processing time because the processor must also spend time to monitor the outputs and update the display. You can shorten your command processing time by turning off the display. To turn off the display, send the command:

DSP 0

To re-enable the display send the command:

DSP 1

You can also find out the status of the display by sending the following query and addressing the supply to talk:

DSP?

The response will be either a "1" or a "0".

Message Display Capability. The display command can also be used to display messages on the front panel. Messages may consist of a maximum of twelve alphanumeric characters. Only upper case alpha characters, numbers, and spaces will be displayed.

For example, to display the message "OUTPUT 2 OK", send the following command:

DSP "OUTPUT 2 OK"

Note The BASIC programming statement for a series 200/300 computer would be as follows:

OUTPUT 705; "DSP""OUTPUT 2 OK""

Other Queries

In the examples discussed above, you saw how to use queries for each function discussed. The following paragraphs describe other queries which were not previously covered.

ERROR Query. The power supply can detect both programming and hardware errors. You can use either the front panel (see page 89) or the GP-IB to find out the type of error. Upon detecting an error, the error annunciator on the front panel and the ERR bit in the serial poll register will be set. When in local mode the supply will display the error name in response to pressing the ERR key on the front panel. Over the GP-IB, only the error code will be returned. After a query, the error bit is cleared. A description of these codes is given in Tables 5-8. To find out what the error is, send the following query and address the supply to talk:

ERR?

The supply will respond with an error code number (see Table 5-8).

ID Query. If you want to know the model number of the power supply you are working with, you can send the ID? query over the GP-IB. To do this send the following over the GP-IB and address the supply to talk.

ID?

The supply will respond with its model number.

Test Query. You can get the power supply to perform a limited self-test at any time during its operation by sending the TEST? query over the GP-IB. This test does not affect the analog control circuits of the supply and it can be performed while the outputs are connected to external circuits. For tests of the analog control circuits refer to Chapter 3. Responses to the test query are described in Table 5-9. This test cannot be done from the front panel. To instruct the power supply to carry out a self-test, send the following query and address the supply to talk:

TEST?

Calibration Mode Query. To be able to calibrate your power supply, the calibration mode (CMODE) must be turned on (See Appendix A for a detailed description of the calibration procedure). To find out if the CMODE is on or off, send the following query over the GP-IB and address the supply to talk:

CMODE?

The supply will respond with a "1" which indicates that CMODE is on or a "0" which indicates that CMODE is off.

DCPON. The DCPON command sets the state of all outputs at power-on. You can specify if the outputs wake up enabled or disabled when the unit is turned on. To enable all outputs at turn-on send:

DCPON 1

To disable all outputs at turn-on send:

DCPON 0

Note that these commands set the output voltage to zero and the output current to a slightly positive value when the OUTPUT OFF command is issued. Therefore, the constant voltage feedback loop is active and the outputs are in constant voltage mode when programmed "OFF".

Starting with firmware revision A.00.04 and later, two additional commands let you set the output current to a slightly negative value when the OUPUT OFF command is issued, causing the outputs to be in constant current mode when programmed "OFF". The benefit of being in constant current mode when the output is off is that if the load impedance and the voltage and current settings are such that the unit is forced into constant current mode at turn on, then the current feedback loop will be active during the transition to OUTPUT ON, and there will be no output current overshoot due to mode crossover.

To enable all outputs in constant current mode at turn on send: DCPON 2

To disable all outputs in constant current mode at turn-on send: DCPON 3

Table 5-8. Error Messages

Front Panel Response	GP-IB Code	Explanation
NO ERROR	0	This is the response to the ERR? query when there are no errors.
INVALID CHAR	1	You sent the supply a character it did not recognize.
INVALID NUM	2	Format of your number is incorrect. Check number syntax.
INVALID STR	3 or 28	Occurs when you send a command the supply does not understand.
SYNTAX ERROR	4	Either too many parameters are sent without delimiters or the number representation is incorrect. Follow the Syntax Diagram in Figure 5-2. Check spaces and delimiters.
NUMBER RANGE	5	An out of range number was sent. Send a new number within the legal range.
NO QUERY	6	Computer addressed the supply to talk, but it did not first request data. Send query first then address supply to talk.
DISP LENGTH	7	Quoted string exceeds the display length of 12 characters. Shorten string to a maximum of 12 characters.
BUFFER FULL	8	This error may occur if too many numbers are sent. Error #4 or #5 may occur first.
EEPROM ERROR	9	EEPROM is not responding correctly to programming commands. An instrument failure has occurred and service is required.
HARDWARE ERR	10	An output error has occurred in an unknown output. Service is required.

Table 5-8. Error Messages (continued)

Front Panel Response	GP-IB Code	Explanation
HDW ERR CH 1	11	Errors 11 through 14 refer to a specific output where there is an output error. Service is required.
HDW ERR CH 2	12	Same as in Error #11.
HDW ERR CH 3	13	Same as in Error #11.
HDW ERR CH 4	14	Same as in Error #11.
NO MODEL NUM	15	The interface cannot find its model number. There may be a hardware failure or the instrument may require reprogramming. Service is required.
CAL ERROR	16	You tried to use either a calibration command with CMODE off or the calibration failed while in CMODE. Enable CMODE and check numbers sent during calibration. Also, there could be a hardware error.
UNCALIBRATED	17	There is an incorrect checksum in the EEPROM possibly as a result of incorrect calibration procedure. Recalibrate, and if the problem persists, your supply has a hardware failure.
CAL LOCKED	18	Calibration was attempted with the Calibration Jumper on the GP-IB board in the lockout position. Reposition jumper if desired. See Service Manual.
SKIP SELF TST	22	The self test jumper on the GP-IB board is in the Skip Self Test position. No self-test was done. This is for diagnostics only. See Service Manual.

Table 5-9. TEST Responses

Code	Explanation
0	This is the response to the TEST? query when there are no errors.
20	The timer has failed self-test. Refer to the troubleshooting section in the Service Manual.
21	The RAM has failed self-test. Refer to the troubleshooting section in the Service Manual.
27	The ROM has failed the checksum test. Refer to the troubleshooting section in the Service Manual.
29	There is an incorrect checksum in the EEPROM for non-volatile state storage. The non-volatile states 0-3 have not been loaded. Store new values, if problem persists, your supply has a hardware failure.
30	The store limit has been reached for CMODE, store states 0-3, DCPON, or SRQ. The power must be turned off/on to reenable.

Local Operation

Introduction

Chapter 3 introduced you to the supply's front panel controls and indicators to help you turn on the supply and perform the checkout procedures that were given in that chapter. The following paragraphs describe how to use all of the front panel controls and indicators. Most of the remote operations described in Chapter 5 can also be performed locally from the supply's front panel.

Local Mode

In order to use the front panel keys to control the supply, the local mode must be in effect. The local mode is in effect immediately after power is applied. Table 5-3 lists the initial settings for all of the power supply's functions when power is initially applied. When the local mode is in effect (RMT annunciator off), the Output Function, System Function, and Numeric Entry keys on the front panel (see Figure 6-1) can be used to operate the power supply.

In the remote mode (front panel RMT annunciator on), the front panel keys will have no effect on any of the supply's outputs and only the computer can control the supply. You can, however, still use the front panel display to view the output voltage and current readings or the present settings for the selected output channel while the supply is in the remote mode.

You can return the supply to the local mode from the remote mode by pressing the LCL key provided that the local lockout command has not been received from the GP-IB controller. Pressing the LCL key will also turn the supply's display back on if it was turned off with a DSP command during remote operation (see page 81). A change between the local and remote modes will not result in a change in the power supply's outputs.

Local Control Of Output Functions

The Output Function keys (see Figure 6-1) allow you to control the selected output. Figure 6-1 shows the annunciator arrow over OUTPUT 2 indicating that output channel 2 is selected. Pressing the OUTPUT SELECT key selects the output channels in forward (▷) or reverse (◁) sequence. Note that Figure 6-1 illustrates the front panel for the Agilent 6626A supply which has four output annunciators. The front panel for Agilent Model 6625 is identical to Figure 6-1 except it has two output annunciators.

General

The power supply will accept programming values directly in volts and amps. The programmable voltage, current, and overvoltage ranges for the outputs of each model are given in Table 5-4. The power supply will round off the values received to the nearest multiple of the resolution for that particular output. If you send a value out of the valid range, it will not be executed and the ERR annunciator will come on. You can get a readout of the error on the display by pressing the ERR key. For an out-of-range error, the error message "NUMBER RANGE" will be displayed.

When you press the VSET, ISET, or OVSET key, the output selected and the present setting for that function will be displayed. You can change the setting using the numeric entry keys. Pressing the number keys will cause the present numeric setting to become blank and be replaced with the new numbers on the display. You can use the ◀ key to erase previous keystrokes if you make a mistake.

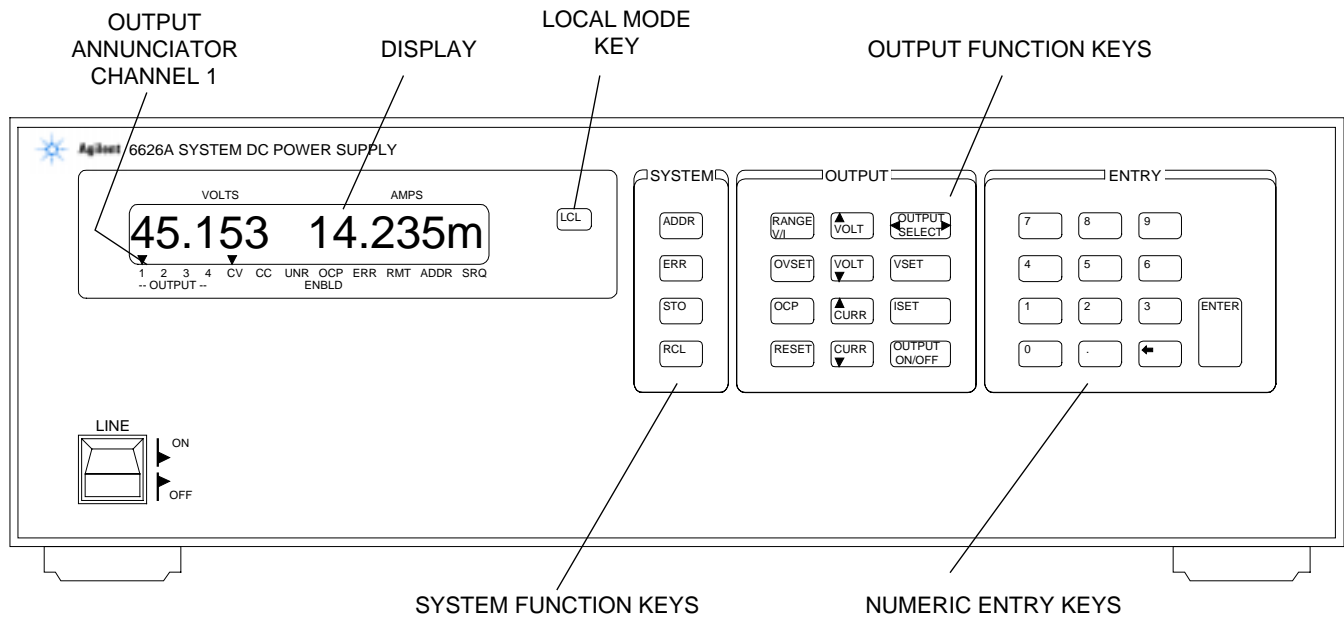

Figure 6-1. Front Panel (Model 6626A shown)

Pressing the ENTER key will enter the values displayed for the function indicated, initiate that function, and return the display to the metering mode in which the measured output voltage and current for the selected output are displayed. Pressing the ENTER key without entering numbers will result in retention of the previous values and return to the metering mode. You can also return to the metering mode at anytime by pressing the RESET key.

The RANGE V/I key is used to display the voltage and current range settings. The key toggles; pressing it will display the range, pressing it again will put the display back to background metering. The range display shows the largest values of voltage and current that can be set for the ranges presently set.

The voltage step and current step (arrow keys) are used to change voltage & current settings and voltage & current ranges. There are 3 modes:

1. To use the step keys to immediately change the output settings, the background metering mode must be in affect.
2. To use the step keys to change the setting, the VSET or ISET key must be pressed first. The step keys can then be used to adjust the setting. Press the ENTER key to change the actual setting.
3. To use the step keys to change the voltage or current ranges first press the RANGE V/I key. The step keys change the range as long as the RANGE display is in effect.

Note The step keys change the voltage or current by 1 LSB each time they are pressed. If the key is held down more than 1 second, the automatic step mode goes into effect. The step rate will start to increase from the initial value after about 3 seconds.

Setting Voltage and Voltage Range

The selected output's voltage is programmed locally using the VSET key. For example, program the voltage to 5.25 volts by pressing:



The front panel display then indicates the actual output voltage and current for the selected output.

The voltage step keys can also be used to change the voltage setting.

or then

The voltage can be set in the immediate execute mode. This mode is in effect when background metering is in effect. Pressing or will change the setting and the effect on the voltage and current can be observed on the display.

The voltage range can be changed by using the RANGE V/I key and the voltage step keys.

or

The range will change as soon as one of the voltage step keys is pressed and the display will be updated. If the voltage setting is greater than the highest value of the low range and the range is changed from high to low, the VSET will be automatically reduced to the maximum voltage of the low range.

Setting Current and Current Range

The selected output's current is programmed locally using the ISET key. For example, program the current to 1.5 amps by pressing:

The power supply will accept any programmed current between zero and the minimum programmable current and automatically set the output to the minimum programmable current without causing a programming error. See Table 5-4.

The current step keys can also be used to change the current setting.

or then

The current can be set in the immediate execute mode. This mode is in effect when background metering is in effect. Pressing or will change the setting and the effect on the voltage and current can be observed on the display.

The current range can be changed by using the RANGE V/I key and the current step keys.

or

The range will change as soon as one of the current step keys is pressed and the display will be updated. If the current setting is greater than the highest value of the low range and the range is changed from high to low, the ISET will be automatically reduced to the maximum current of the low range.

Enabling/Disabling an Output

The selected output channel can be turned on and off from the front panel. The OUTPUT ON/OFF key toggles the selected output on and off. When an output is turned off, the message "DISABLED" will be displayed.

The OUTPUT ON/OFF key will not affect any other programmed functions nor will it reset an overvoltage or overcurrent condition. An output disabled by the OUTPUT ON/OFF key will behave as if it were programmed to zero volts and 10 mA.

Setting Overvoltage Protection

Programmable overvoltage protection (OVP) guards your load against overvoltage by crowbaring and downprogramming the power supply output if the programmed overvoltage setting is exceeded.

A fixed OV circuit with a trip level about 20 percent above the maximum programmable voltage acts as a backup to the programmable OVP. When overvoltage protection is activated, the output is shorted and the message "OVERVOLTAGE" will appear on the front panel display.

The selected output's overvoltage setting is programmed locally using the OVSET key. For example, program the overvoltage to 10.5 volts by pressing:



Resetting Overvoltage Protection

The condition that caused the OVP must first be cleared and then the output can be returned to its previous state by pressing the RESET key.

Enabling/Disabling Overcurrent Protection

The overcurrent protection feature guards against excessive output currents. When the output goes into the + CC mode and OCP is enabled, the OCP circuit is activated which downprograms the output voltage and disables the output. For this condition, the message "OVERCURRENT" appears on the front panel display.

The selected output's overcurrent protection feature can be turned on and off from the front panel. The OCP key toggles the selected output's overcurrent protection circuit on and off. When it is on (enabled), the OCP ENBLD annunciator will be on.

Resetting Overcurrent Protection

The condition that activated the OCP circuit must first be cleared and then the output can be returned to its previous state by pressing the RESET key.

Local Control Of System Functions

The System Function keys consist of the ADDR, ERR, STO, and RCL keys as shown in Figure 6-1. These keys are independent of the output selected and are used in setting the supply's GP-IB address, displaying error messages, and storing/recalling voltage and current settings for all of the supply's output channels.

Setting the Supply's GP-IB Address

As described in page 40, before you can operate the supply remotely, you must know its GP-IB address. You can find this out locally from the front panel by pressing:



The supply's present address will appear in the display. Address 5 is the factory set address.

If you want to leave the address set at 5, you can return to the metering mode by pressing the METER key or you can press another function key.

If you want to change the address, you can enter a new value.

Any integer from 0 through 30 can be selected.

For example, you can change the address of your supply to 10 by pressing:

ADDR 1 0 ENTER

Displaying Error Messages

The power supply can detect both programming and hardware errors. Upon detecting an error, the ERR annunciator on the front panel comes on and the ERR bit in the serial poll register will be set (see page 78).

When an error is detected, you can display the error message by pressing the ERR key. The power supply will return the error message to the display and clear the error bit. For example, if you program a number that is not within the valid range, the ERR annunciator will come on. You can display the error message by pressing the ERR key. In this case, the error message "NUMBER RANGE" will be displayed. Errors generated either locally from the front panel or remotely from the GP-IB computer can be displayed by pressing the ERR key only when the supply is in the local mode. Pressing the ERR key also clears the error bit so if you press ERR again, the message "NO ERROR" will appear. All error codes and associated display messages are listed in Table 5-8.

Storing and Recalling Voltage and Current Settings for All Outputs

As described on page 75, the power supply has 11 internal registers for storing voltage and current settings of all outputs. At power on each location contains zero volts and the minimum current limit (see initial conditions on page 71).

The STO and RCL keys allow you to store and recall voltage and current settings for all your output channels from any of the 11 internal registers (numbered 0 through 10). For example, you can store the present settings of voltage and current for all the output channels in internal register 2 by pressing:

STO 2 ENTER

You can change the settings of any of your supply's outputs any number of times as required and then program them to the settings stored in internal register 2 by pressing:

RCL 2 ENTER

The internal registers 0-3 will retain the settings when power is turned off. When power is turned off and then on again, registers 4-10 will be reset to zero voltage and the current to 10 mA. Register 0 is the power on state. The power will be programmed from values in register 0 at power on.

The advantages in using the internal registers are that command processing time is saved and repetitive programming of different settings is simplified. The STO key can be used in conjunction with the OUTPUT ON/OFF key to store settings while the outputs are disabled (OFF). These stored settings can be used later to program the outputs to the stored settings using the RCL and OUTPUT ON/OFF keys.

Alignment Procedures

Introduction

This appendix contains the software alignment procedures for the power supply. These supplies should be aligned twice a year, or whenever certain repairs are made (see Service Manual).

The equipment that you need and the test setups to perform the alignment are also shown. A listing of the alignment procedure appears at the end of Appendix A. Refer to Appendix C (Command Summary) for detailed explanations of the commands used within the alignment program.

Because there are no internal or external hardware adjustments, your power supply can be aligned without removing the covers or removing it from the cabinet if it is rack mounted. Alignment is performed by measuring actual output values and sending them to the supply over the GP-IB.

Security against accidental alignment is available. A jumper inside the unit may be moved from NORMAL to CAL LOCKOUT to disable all alignment commands. Access to this jumper requires opening the unit (see Service Manual).

If a number returned to the power supply is out of range while running the alignment program, the front panel ERR annunciator will indicate an error. For example, an error will be created if the DMM is connected to measure a current when a voltage measurement is anticipated by the program.

Note The memory used to store correction constants will accept and store data about 10,000 times, which is more than sufficient for normal calibrations over the life of the instrument. However, do not put the unit in a calibration loop that repeatedly turns the calibration mode on and off.

Test Equipment and Setup Required

The following test equipment is required for alignment:

1. A computer connected to the GP-IB connector on the back of the power supply.
2. An Agilent 3458A Digital Multimeter (DMM).
3. A precision 0.1 ohm $\pm 0.003\%$, 5 A shunt resistor (4 terminal). Recommended--Leeds & Northrop Part Number 4221-B (in oil bath) or Guildline - Part Number 9330././Agilent (in air).

In line 130, change the constant SHUNT_r to the actual measured value of the shunt being used.

Figures A-1 through A-5 show setups required for aligning the power supply. You will be instructed by the program to refer to a particular setup. Observe polarity when connecting the DMM.

Calibration Program

The following alignment program can be used as is, provided you have an HP Series 200/300 computer with the BASIC programming language and an Agilent 3458A DMM. Refer to Appendix C (Command Summary) for further information on the commands used within the program.

The program contains embedded comments (identified by a leading asterisk { ! }) which explain various sections and procedures. To reduce keystroking, the program may be shortened to a minimum number of lines by eliminating these comments.

The alignment program is available on a 5¼ floppy (Agilent P/N 06626-10001) or 3½ inch microfloppy (Agilent P/N 06626-10002). Both disks also contain a verification program, which tests the power supply's output programming and readback accuracy to ensure that it is aligned correctly.

The program will automatically recognize what model power supply is being tested, the number of outputs the power supply has, and which type output it is testing. Using this information, the program will calibrate each of the power supply.

After the program has finished calibrating the power supply, it will store the calibration constants and turn off the calibration mode.

Type in the program and press RUN.

The program first does some "house keeping".

It will clear the screen, and assign a number of Common Variables (lines 100 - 130).

The program next assigns the address of the power supply to 705 (line 160) and the address of the DMM to 722 (line 170). It will then assign the CRT as the output device (line 180) and the value of the current shunt. Enter the exact measured value at line 190.

The power supply is sent a CLR command (line 210), which will set it to the turn on state. It will then identify what model power supply is being tested (lines 220 and 230).

Next it will preset the DMM (line 250) and set the DMM sample (line 260).

It will now place the power supply in calibration mode (line 300).

The program is now ready to perform the calibrations on the power supply.

The program will first perform a subprogram (called at line 360 and performed in lines 3420 - 3630) which will set up the output parameters of the output under test.

The program will then calibrate its voltage programming and readback circuitry (the subprogram is called at lines 370 and 380, and performed in lines 1430 - 1920). During this subprogram, the controller will pause, and request that the user set up the power supply and DMM referring to a figure in this Appendix. Press CONTINUE when ready.

Next the overvoltage circuitry will be calibrated (the subprogram is called in line 390, and performed in lines 1960 - 2070).

The current alignment tests on the 2 Amp, 50 W outputs are made using a shunt, be sure that the DMM is connected to the HI and LO voltage input terminals when the shunt is used.

The current circuitry will be calibrated next (the subprogram is called in lines 400 and 410, and performed in lines 2110 - 2700). During this subprogram, the controller will pause and request that the user set up the power supply and DMM referring to a figure in this Appendix. Press CONTINUE when ready.

Finally the program will calibrate its current sink readback circuitry (performed in lines 2740 - 3380).

To perform the current sink readback alignment on the Agilent 6626A, outputs of equivalent current capability are used as pairs. For example outputs 1 and 2 are used to test each other, the outputs 3 and 4 are used to test each other.

In order to perform the current sink readback alignment on the Agilent 6625A, the program automatically limits the current of output 2 (the 50 W output) to 0.5 Amps (line 2780).

After testing of a channel is completed, the program will check if any errors have occurred (the subprogram is called in line 850 and performed in lines 3670 - 3780). If an error has occurred, a message will be sent to the output device (CRT).

After all outputs are tested without errors, the CAL MODE will be turned off, and the calibration constants stored.

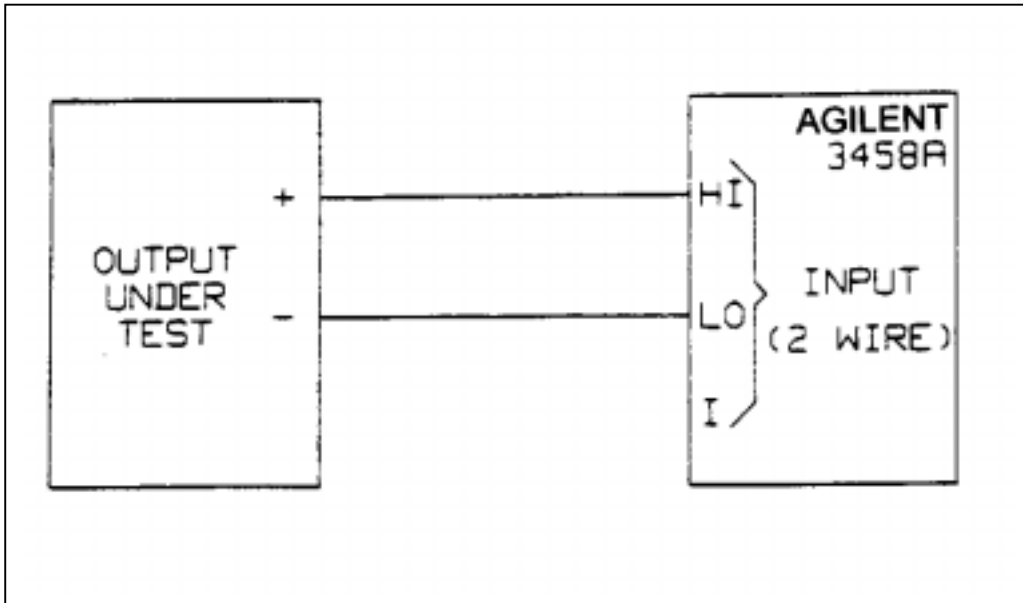

Figure A-1

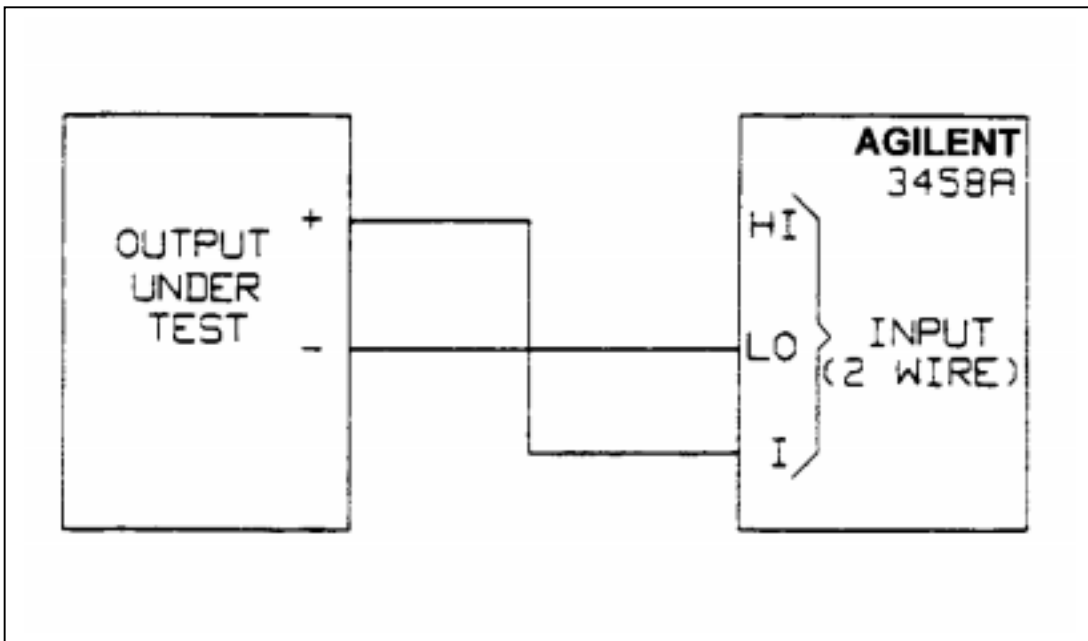

Figure A-2

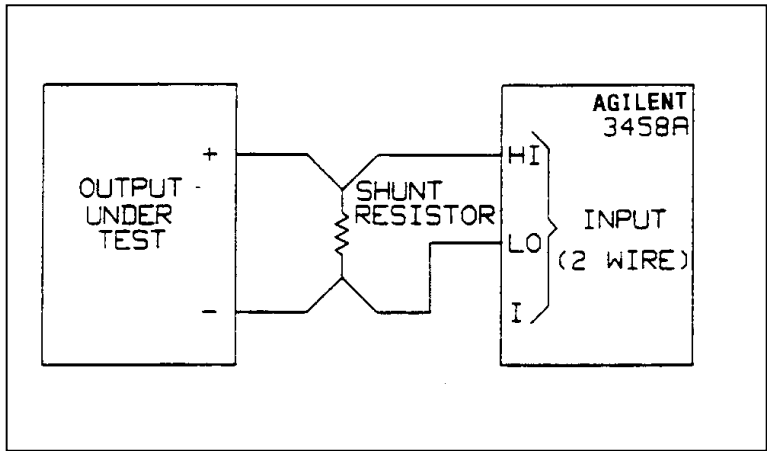

Figure A-3

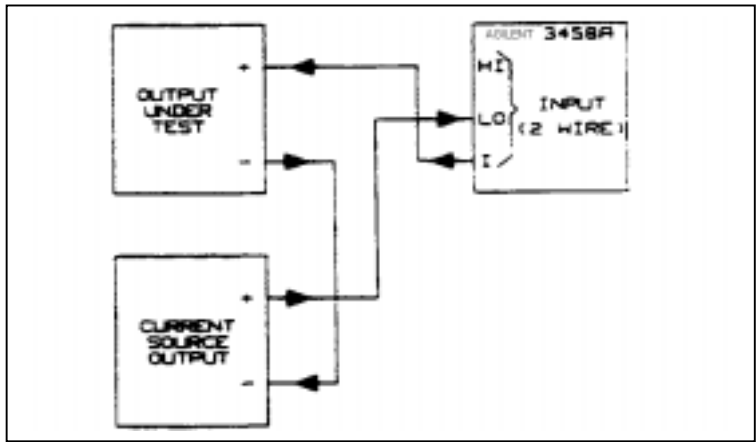

Figure A-4

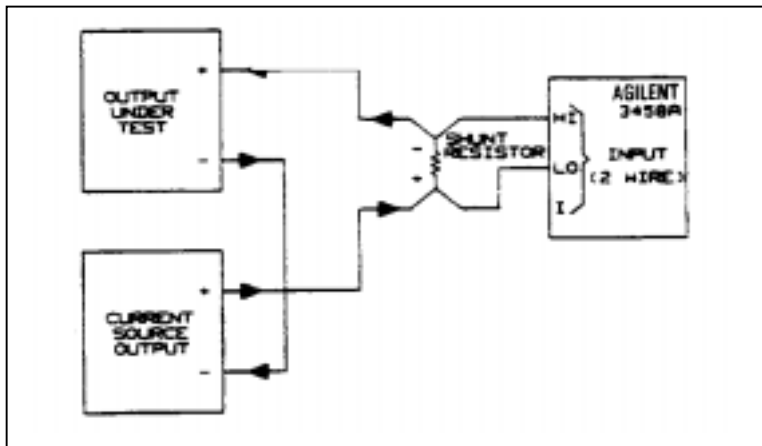

Figure A-5

Alignment Program

```
10 ! This program called "ALIGN_6626" will align
20 ! the Agilent6625A, 26, 28 and 29A Power Supplies It
30 ! requires an Agilent3458A DMM and a four terminal
40 ! 0.1 ohm current shunt accurate to +/-50 ppm
50 !
60 ! May 06,1989 Rev A.03.01
70 !
80 Clear_screen                ! Call program to clear display
90 !
100 COM /Specs/ Vrng_lo,Vrng_hi,Irng_lo,Irng_hi
110 COM /Ps/ Chan,Other_chan,@Ps,Model${7}
120 COM /Outputs/ No_of_outputs
130 COM /Vm/ @Vm
140 COM /Shunt/ Shunt_r
150 !
160 ASSIGN @Ps TO 705          ! Set Supply address to 705
170 ASSIGN @Vm TO 722          ! Set DMM address to 722
180 PRINTER IS 1              ! Print to the CRT
190 Shunt_r= 1                 ! Set value of current shunt
200 !
210 OUTPUT @Ps;"CLR"          ! Preset Supply to turn on state
220 OUTPUT @Ps;"ID?"          ! Queries Supply model number
230 ENTER @Ps;Model$          ! Enter model number
240 !
250 OUTPUT @Vm;"PRESET NORM;TRIG HOLD" ! Preset DMM
260 OUTPUT @Vm; "NPLC 100"    ! Set DMM sample
270 !
280 !
290 !
300 OUTPUT @Ps;"CMODE 1"      ! Turn on Supply CAL mode
310 !
320 IF Model$="Agilent6625A" OR Model$='Agilent6628A' THEN No_of_outputs=2
330 IF Model$="Agilent6626A" OR Model$="Agilent6629A" THEN No_of_outputs=4
340 !
350 FOR Chan=1 TO No_of_outputs ! Loop to test all outputs
360   Get_data                 ! Call program with range data
370   Cal_voltage(Vrng_lo)     ! Call program to cal low range voltage
380   Cal_voltage(Vrng_hi)     ! Call program to cal high range voltage
390   Cal_overvoltage(Vrng_hi) ! Call program to cal overvoltage
400   Cal_current(Irng_lo)     ! Call program to cal low range current
410   Cal_current(Irng_hi)     ! Call program to cal high range current
420 NEXT Chan                  ! Test next output
430 !
440 Chan=1                     ! Select channel to cal sink (-CC)
450 Other_chan=2               ! Select current source channel
460 Get_data                   ! Call program with range data
470 Cal_sink(Irng_lo,1)        ! Call program to cal low range sink
480                            ! 1 is + polarity for DMM
490 Chan=2                     ! Select channel to cal sink (-CC)
500 Other_chan=1               ! Select current source channel
510 Get_data                   ! Call program with range data
520 Cal_sink(Irng_lo,-1)       ! Call program to cal low range sink
```

Alignment Program (continued)

```
530 ! -1 is reverse polarity, this saves
540 ! reversing leads as sink channel
550 ! becomes the source for other channel
560 Chan=1 ! Select channel to cal sink (-CC)
570 Other_chan=2 ! Select current source channel
580 Get_data ! Call program with range data
590 Cal_sink(Irng_hi,1) ! Call program to cal high range sink
600 !
610 Chan=2 ! Select channel to cal sink (-CC)
620 Other_chan=1 ! Select current source channel
630 Get_data ! Call program with range data
640 Cal_sink(Irng_hi,-1) ! Call program to cal high range sink
650 !
660 IF No_of_outputs=4 THEN ! Cal outputs 3 & 4
670 Chan=3 ! Select channel to cal sink (-CC)
680 Other_chan=4 ! Select current source channel
690 Get_data ! Call program with range data
700 Cal_sink(Irng_lo,1) ! Call program to cal low range sink
710 !
720 Chan=4 ! Select channel to cal sink (-CC)
730 Other_chan=3 ! Select current source channel
740 Cal_sink(Irng_lo,-1) ! Call program to cal low range sink
750 !
760 Chan=3 ! Select channel to cal sink (-CC)
770 Other_chan=4 ! Select current source channel
780 Cal_sink(Irng_hi,1) ! Call program to cal high range sink
790 !
800 Chan=4 ! Select channel to cal sink (-CC)
810 Other_chan=3 ! Select current source channel
820 Cal_sink(Irng_hi,-1) ! Call program to cal high range sink
830 END IF
840 :
850 Check_error ! Call error checking program
860 Cal_mode_off ! Call program to turn cal mode off
870 !
880 END
890 !
900 !
910 !
920 SUB Clear_screen ! Subprogram to clear display
930 OUTPUT 2;CHR$(255)&CHR$(75); ! Clear screen
940 SUBEND
950 !
960 !
970 !
980 DEF FNDcv ! Function to r at voltage
990 COM /Vm/ @Vm
1000 OUTPUT @Vm;"DCV" ! Set DMM to read DC voltage
1010 TRIGGER @Vm ! Take a voltage reading
1020 ENTER @Vm;Volts ! Enter the voltage
1030 RETURN Volts ! Return voltage reading
1040 FNEND ! End of voltage function
```

Alignment Program (continued)

```
1050 !
1060 !
1070 !
1080 DEF FNDci(I_range)           ! Function to read current
1090   COM /Vm/ @Vm
1100   COM /Shunt/ Shunt_r
1110   IF I_range=2 THEN           ! 2A must read across shunt
1120     Amps=FNDcv/Shunt_r       ! Convert shunt voltage to Amps
1130   ELSE!                       ! <2A read direct from DMM
1140     OUTPUT @Vm;"DCI"         ! Set DMM to read DC current
1150     TRIGGER @Vm              ! Take a current reading
1160     ENTER @Vm;Amps           ! Enter the current
1170   END IF
1180   RETURN Amps                ! Return the current reading
1190 FNEND
1200 !
1210 !
1220 !
1230 SUB Output_on                 ! Subprogram to turn ON outputs
1240   COM /Ps/ Chan,Other_chan, @Ps, Model$[7]
1250   COM /Outputs/ No_of_outputs
1260   OUTPUT @Ps; OUT 1,1;OUT 2,1 ! Turn on outputs 1 & 2
1270   IF No_of_outputs=4 THEN OUTPUT @Ps;"OUT 3,1;OUT 4,1"
1280                                     ! Turn on outputs 3 & 4
1290 SUBEND
1300 !
1310 !
1320 !
1330 SUB Output_off               ! Subprogram to turn OFF outputs
1340   COM /Ps / Chan, Other_chan, @Ps, Model$ [ 7 ]
1350   COM /Outputs/ No_of_outputs
1360   OUTPUT @Ps;"OUT 1,0,OUT 2,0" ! Turn off outputs 1 & 2
1370   IF No_of_outputs=4 THEN OUTPUT @Ps; "OUT 3,0;OUT 4,0"
1380                                     ! Turn off outputs 3 & 4
1390 SUBEND
1400 !
1410 !
1420 !
1430 Cal_voltage : SUB Cal_voltage(V_range) ! Subprogram to cal voltage
1440   COM /Ps/ Chan,Other_chan,@Ps,Model$ [7]
1450   !
1460   IF V_range=50 THEN GOTO Cal_v    ! Skip setup instructions
1470   Output_off                       ! Turn off all outputs
1480   Clear_screen
1490   PRINT "Set up output";Chan;"for voltage calibration"
1500   PRINT
1510   PRINT " Use Fig A-1 of the Operating Manual"
1520   PRINT
1530   PRINT " 3458A input is connected to VOLTAGE terminals"
1540   PRINT
1550   PRINT " The current shunt is NOT used"
1560   PRINT
```

Alignment Program (continued)

```
1570 PRINT "Press CONTINUE when ready
1580 PAUSE
1590 Output_on
1600 !
1610 Cal_v: !
1620 Clear_screen
1630 PRINT "Calibrating the";V_range;"volt range programming"
1640 !
1650 OUTPUT @Ps;"VRSET" ;Chan,V_range ! Set voltage range
1660 !
1670 OUTPUT @Ps; VLO";Chan ! Set to low output voltage
1680 WAIT 1 ! Wait for supply to stabilize
1690 Vlo=FNDcv ! Read low voltage
1700 !
1710 OUTPUT @Ps; "VHI" ;Chan ! Set to high output voltage
1720 WAIT 1 ! Wait for supply to stabilize
1730 Vhi=FNDcv ! Read high voltage
1740 !
1750 OUTPUT @Ps; "VDATA" ;Chan, Vlo, Vhi ! Send output voltage data
1760 !
1770 Clear_screen
1780 PRINT "Calibrating the";V_range,'volt range readback"
1790 !
1800 OUTPUT @Ps; VRLO";Chan ! Set low readback voltage
1810 REPEAT ! Wait for supply to finish
1820 UNTIL BIT(SPOLL(@Ps),4) ! Finished when Bit 4 goes true
1830 Vrlo=FNDcv ! Read low output voltage
1840 !
1850 OUTPUT @Ps; "VRHI";Chan ! Set high readback voltage
1860 REPEAT ! Wait for supply to finish
1870 UNTIL BIT(SPOLL(@Ps),4) ! Finished when Bit 4 goes true
1880 Vrhi=FNDcv ! Read high output voltage
1890 !
1900 OUTPUT @Ps; "VRDAT"; Chan, Vrlo, Vrhi ! Send voltage readback data
1910 !
1920 SUBEND
1930 !
1940 !
1950 !
1960 Cal_overnoltage:SUB Cal_overnoltage(V_range) ! Sub program to cal OV
1970 COM /Ps/ Chan,Other_chan,@Ps,Model$[7]
1980 !
1990 Clear_screen
2000 PRINT "Calibrating the Overvoltage circuit
2010 !
2020 OUTPUT @Ps;"VRSET";Chan,V_range ! Set voltage range
2030 OUTPUT @Ps;"OVCAL";Chan ! Calibrate Overvoltage
2040 REPEAT ! Wait for supply to finish
2050 UNTIL BIT(SPOLL(@Ps),4) ! Finished when Bit 4 goes true
2060 !
2070 SUBEND
2080 !
```

Alignment Program (continued)

```
2090 !
2100 !
2110 Cal_current: SUB Cal_current(I_range)           ! Subprogram to cal current
2120   COM /Ps/ Chan,Other_chan,@Ps,Model$[7]
2130   !
2140   IF I_range=.5 THEN GOTO Cal_i                 ! Skip setup instructions
2150   !
2160   Output_off
2170   !
2180   Clear_screen
2190   PRINT "Set up output";Chan;"for";I_range;"A current calibration"
2200   PRINT
2210   IF I_range=2 THEN                             ! If the next cal range is 2
2220                                           ! amps then print this message
2230   PRINT " Use Fig A-3 of the Operating Manual"
2240   PRINT
2250   PRINT "3458A input is connected to VOLTAGE terminals"
2260   PRINT
2270   PRINT "The current shunt IS used"
2280 ELSE                                           ! If not 2 amps then print this
2290   PRINT "Use Fig A-2 of the Operating Manual"
2300   PRINT
2310   PRINT "3458A input is connected to CURRENT terminals"
2320   PRINT
2330   PRINT "The current shunt is NOT used"
2340 END IF
2350 PRINT
2360 PRINT "Press CONTINUE when ready"
2370   PAUSE
2380   Output_on
2390   !
2400 Cal_i :   !
2410   Clear_screen
2420   PRINT "Calibrating the";I_range;"A current programming
2430   !
2440   OUTPUT @Ps;"IRSET";Chan,I_range             ! Set current range
2450   OUTPUT @Ps;"ILO";Chan                       ! Set output current low
2460   WAIT 1                                       ! Wait for supply to stabilize
2470   Ilo=FNDci(I_range)                          ! Read low output current
2480   !
2490   OUTPUT @Ps;"IHI";Chan                       ! Set output current high
2500   WAIT 1                                       ! Wait for supply to stabilize
2510   Ihi=FNDci(I_range)                          ! Read high output current
2520   !
2530   OUTPUT @Ps;"IDATA";chan,Ilo,Ihi            ! Set output current data
2540   !
2550   Clear_screen
2560   PRINT "Calibrating the";I_range;"A current readback"
2570   !
2580   OUTPUT @Ps;"IRLO";Chan                     ! Set low readback current
2590   REPEAT                                       ! Wait for supply to finish
2600   UNTIL BIT(SPOLL(@Ps),4)                    ! Finished when Bit 4 goes true
```

Alignment Program (continued)

```
2610     Irlo=FNDci(I_range)                ! Read low output current
2620     !
2630     OUTPUT @Ps;"IRHI";Chan             ! Set high readback current
2640     REPEAT                             ! Wait for supply to finish
2650     UNTIL BIT(SPOLL(@Ps),4)           ! Finished when Bit 4 goes true
2660     Irhi=FNDci(I_range)                ! Read high output current
2670     !
2680     OUTPUT @Ps;"IRDAT";Chan,Irlo,Irhi  ! Send current readback data
2690     !
2700 SUBEND
2710 !
2720 !
2730 !
2740 Cal_sink SUB Cal_sink(I_range,Polarity) ! Subprogram to cal -CC
2750     COM /Ps/ Chan,Other_chan,@Ps,Model$[7]
2760     !
2770     IF I_range=.5 THEN GOTO Sink_rb     ! Skip setup instructions
2780     IF Model$="Agilent6625A" AND I_range=2 THEN I_range=.5
2790                                     ! If a 6625A, 2A output will be
2800                                     ! set to 5A to match output 1
2810     IF Chan=2 OR Chan=4 THEN GOTO Sink_rb ! Skip setup instructions
2820     !
2830     Output_off
2840     Clear_screen
2850     PRINT "Set up output";Chan;"for ;I_range; "A current SINK cal"
2860     PRINT
2870     PRINT "Connect outputs";Chan;"and" ;Other_chan;"together as in"
2880     !
2890     IF I_range=2 THEN                  ! If it is 2A output use setup 5
2900         PRINT " Fig A-5 of the Operating Manual"
2910         PRINT
2920         PRINT " 3458A input is connected to VOLTAGE terminals"
2930         PRINT
2940         PRINT " The current shunt IS used for this part"
2950         PRINT " of the alignment"
2960     ELSE                                ! If not 6626A 2A use setup 4
2970         PRINT "Fig A-4 of the Operating Manual"
2980         PRINT
2990         PRINT "3458A input is connected to CURRENT terminals"
3000         PRINT
3010         PRINT " The current shunt IS NOT used"
3020     END IF
3030     PRINT
3040     PRINT "The sink readback of both outputs"
3050     PRINT "will be aligned with this setup"
3060     !
3070     PRINT
3080     PRINT "Press CONTINUE when ready"
3090     PAUSE
3100     !
3110 Sink_rb
3120     Clear_screen
```

Alignment Program (continued)

```

3130 PRINT "Calibrating output";Chan;"";I_range;"A current sink readback"
3140 !
3150 OUTPUT @Ps;"IRSET";Chan,I_range;"IRSET";Other_chan,I_range
3160 ! Set I range for source and
3170 ! sink range
3180 OUTPUT @Ps; "ISET";Other_chan,0;"VSET";Other_chan,7
3190 ! Set source V & I output
3200 Output_on
3210 WAIT 1 ! Wait for source to stabilize
3220 !
3230 OUTPUT @Ps;"IRLN";Chan ! Set sink readback low
3240 REPEAT ! Wait for supply to finish
3250 UNTIL BIT(SPOLL(@Ps),4) ! Finished when Bit 4 goes true
3260 Ilo=(FNDci(I_range))*Polarity ! Read low sink current
3270 !
3280 OUTPUT @Ps;"ISET";Other_chan,I_range ! Set source output current
3290 WAIT 1
3300 !
3310 OUTPUT @Ps;"IRHN";Chan ! Set sink readback high
3320 REPEAT ! Wait for supply to finish
3330 UNTIL BIT(SPOLL(@Ps),4) ! Finished when Bit 4 goes true
3340 Ihi=(FNDci(I_range))*Polarity ! Read high sink current
3350 !
3360 OUTPUT @Ps; NIDAT";chan,Ilo,Ihi ! Send current sink data
3370 !
3380 SUBEND
3390 !
3400 !
3410 !
3420 Get_data SUB Get_data ! Subprogram with range data
3430 COM /Specs/ Vrng_lo,Vrng_hi,Irng_lo,Irng_hi
3440 COM /Ps/ Chan,Other_chan,@Ps,Model$[7]
3450 !
3460 IF Model$="Agilent6625A" AND Chan=1 THEN RESTORE Type_1_data
3470 IF Model$="Agilent6625A" AND Chan=2 THEN RESTORE Type_2_data
3480 IF Model$="Agilent6626A" AND Chan=1 THEN RESTORE Type_1_data
3490 IF Model$="Agilent6626A" AND Chan=2 THEN RESTORE Type 1 data
3500 IF Model$="Agilent6626A" AND Chan=3 THEN RESTORE Type_2_data
3510 IF Model$="Agilent6626A" AND Chan=4 THEN RESTORE Type_2_data
3520 IF Model$="Agilent6628A" OR Model$="Agilent6629A" THEN RESTORE Type_2_data
3530 !
3540 READ Vrng_lo,Vrng_hi,Irng_lo,Irng_hi ! Read the Range data
3550 !
3560 !
3570 ! Output variables range data
3580 ! Vrng Irng
3590 ! Lo Hi Lo Hi
3600 Type 1 data:DATA 7, 50, .015, .500 ! Type 1 data (25W output)
3610 Type_2_data:DATA 16, 50, .200, 2 ! Type 2 data (50W output)
3620 !
3630 SUBEND
3640 !

```

Alignment Program (continued)

```
3650 !
3660 !
3670 Check_error:SUB Check_error          ! Subprogram to check for errors
3680     COM /Ps/ Chan,Other_chan,@Ps,Model$[7]
3690     Clear_screen
3700     PRINT "Checking for errors"
3710     OUTPUT @Ps;"ERR?"                ! Query supply for errors
3720     ENTER @Ps;Err                    ! Enter the error number
3730     IF Err>0 THEN                    ! If an error then print msg
3740         PRINT "Error";Err;"occurred. Supply may not be calibrated"
3750         PRINT "The alignment program is stopped"
3760     STOP
3770     END IF
3780 SUBEND
3790 !
3800 !
3810 !
3820 Cal_mode_off:SUB Cal_mode_off        ! Subprogram to turn off cal mod
3830     COM /Ps/ Chan,Other_chan,@Ps,Model$[7]
3840     Clear_screen
3850     PRINT "wait while calibration constants are stored"
3860     OUTPUT @Ps;"CMODE 0"            ! Turn cal mode off, store data
3870     OUTPUT @Ps;"CLR"                ! Clear supply
3880     Clear_screen
3890     PRINT "Calibration complete"
3900 SUBEND
3910 !
```

Programming With a Series 200/300 Computer

Introduction

The purpose of this appendix is to serve as an introduction to programming your power supply with an HP Series 200/300 computer using the BASIC language. Examples are included that employ some of the most frequently used functions. These examples have been written so that they will run on all power supplies. The values used in the examples (5 V and 0.5 A for instance), are within the operating locus of all outputs on all models. The examples program only channels one and two because both models contain at least two channels (outputs).

You must be familiar with the BASIC language to understand the examples. If you do not recognize a programming statement, look up the keyword in the BASIC Language Reference document that was supplied with your computer, and look up the device command in Chapter 5 of this manual. Questions about program structure and selection are discussed in the BASIC Programming Techniques manual.

I/O Path Names

Throughout this appendix, I/O path names are used in place of interface and device select codes. In a large program, I/O path names simplify changing the address of an instrument if necessary. Reading and writing the program is easier as well. The I/O path name can be carried in a common block and changed by a single assign statement.

In the programming examples in this appendix, the I/O path name @Ps is used for the power supply. The ASSIGN statement that defines the I/O path must precede any statements that use the I/O path name. Therefore, instead of using the statement OUTPUT 705;"VSET1,5" in the following programs, the equivalent OUTPUT @Ps;"VSET1,5" statement is used. The examples assume that the power supply is at address 5 and the GP-IB interface in the computer is at select code 7(factory default).

Voltage and Current Programming

The power supply normally functions in one of two modes, either constant voltage with current limit or constant current with voltage limit. The operating mode is determined by a combination of voltage and current settings and load resistance. For example, with a 50 Ω load connected to output 1, the following program will put output 1 in constant voltage mode at 5 volts out with a 0.5 amp current limit. In this case the output current would be 0.1 A.

```
10 ASSIGN @Ps TO 705
20 OUTPUT @Ps;"VSET1,5;ISET1,0.5"
30 END
```

Line 10: Assigns the I/O pathname to the power supply.

Line 20: Sets output voltage and current. Note the use of the semicolon to separate multiple device commands.

If a 4 Ω load were used instead of a 50 Ω load, output 1 would have been operating in constant current mode at 0.5 amp out with a voltage limit of 5 volts. In this case the output voltage would be 2 V.

VOLTAGE AND CURRENT PROGRAMMING WITH VARIABLES

You can use variables in a program to represent data values in the device commands. This is useful in applications that require changing the voltage and current values to different predetermined settings. The following program uses a variable in a FOR NEXT loop to ramp up output voltage in 0.1 volt steps from 0 to 5 volts.

```
10 ASSIGN @Ps TO 705
20 OUTPUT @Ps;"CLR;ISET1,0.5"
30 FOR Voltage=0 TO 5 STEP 0.1
40 OUTPUT @Ps;"VSET1,";Voltage
50 WAIT 0.2
60 NEXT Voltage
70 END
```

Line 10: Assigns the I/O pathname to the power supply.
Line 20: Initializes the power supply to its power on state and sets the current limit.
Line 30,60: Increments the voltage in 0.1 V steps to 5 volts.
Line 40: Sets the voltage of output 1 to the value of the variable "Voltage". The comma inside the quotes is required because it separates numbers in the device command (the output channel number from the voltage value in this case). A space < SP > may also be used instead of the comma. The semicolon outside the quotes is used because it suppresses the <CR> < LF> that the computer would normally send to the power supply if a comma were used as a separator after a string item. Using a comma in this case would produce a syntax error in the power supply.
Line 50: Waits 0.2 seconds between steps.

Another way to use variables to represent data values in device commands is when using input statements to program the power supply. The following program uses input statements to program the voltage and current settings of output 1 and output 2.

```
10 ASSIGN @Ps TO 705
20 INPUT "ENTER A VOLTAGE FOR OUTPUT #1",V1
30 INPUT "ENTER A CURRENT LIMIT FOR OUTPUT #1",I1
40 INPUT "ENTER A VOLTAGE FOR OUTPUT #2",V2
50 INPUT "ENTER A CURRENT LIMIT FOR OUTPUT #2",I2
60 OUTPUT @Ps;"VSET1,";V1;"ISET1,";I1;"VSET2,";V2;"ISET2,";I2
70 END
```

Line 10: Assigns the I/O pathname to the power supply.
Line 20,30: Enters voltage and current values for output 1.
Line 40,50: Enters voltage and current values for output 2.
Line 60: Sets the voltage and current of outputs 1 and 2 to the values entered into the variables. The previous example explained the use of the comma inside the quotes and the semicolon that precedes the variable. The semicolon that follows the variable suppresses the comma that the computer would normally send to the power supply if a comma were used as a separator after a numeric item. The leading semicolons inside the quotes separate multiple device commands (the VSET commands from the ISET commands in this case).

Voltage and Current Readback

Reading back data from the power supply requires two statements. First, an output statement is used to query the power supply. A list of queries appears in Table 5-2 on page 70. The power supply responds to the query by entering the requested data into a buffer. Next, an enter statement is used to read the data from the buffer on the power supply into a variable in the computer. The following program queries the power supply for the voltage and current settings of output 1 and prints the results on the screen.

```

10 ASSIGN @Ps TO 705
20 OUTPUT @Ps;"VSET?1"
30 ENTER @Ps;Vsl
40 OUTPUT @Ps;"ISET?1"
50 ENTER @Ps;Isl
60 PRINT "VOLTAGE SETTING OF OUTPUT #1 = ";Vsl
70 PRINT "CURRENT LIMIT SETTING OF OUTPUT #1 = ";Isl
80 END

```

Line 10: Assigns the I/O pathname to the power supply.
Line 20,30: Queries the supply for output 1's voltage setting. You cannot string multiple queries together in a single device command because the power supply can only return the most recently queried data.
Line 40,50: Queries the supply for output 1's current limit.
Line 60,70: Prints the results of the queries on the screen.

Programming Power Supply Registers

Present Status

The power supply makes available several forms of status information. Chapter 5 discusses the different registers and their functions. The present status register contains continuously updated information. The following example shows how to query bit position 0 of output 1's status register to see if output 1 is in CV mode. In this example, the program references the function as a variable in a conditional execution statement. Note that instead of printing a message, line 30 could be used to branch to another part of the program in the event that the supply is in CV mode.

```

10 ASSIGN @Ps TO 705
20 COM /Ps/ @Ps
30 IF FNCv _ mode THEN
40 PRINT "OUTPUT 1 IS IN CV MODE"
50 END IF
60 END
70 !
80 !
90 DEF FNCv _ mode
100 COM /Ps/ @Ps
110 OUTPUT @Ps;"STS?1"
120 ENTER @Ps;Sts
130 RETURN BIT(Sts,0)
140 FNEND

```

Line 10: Assigns the I/O path name to the power supply.
Line 20: Declares a common block for the I/O path name. The COM statement must be used for the @Ps variable to preserve its value in the function subprogram.
Line 30,40,50: If FNCv _ mode is true, print the message.
Line 90: Defines the Cv _ mode function.
Line 100: Brings in the common block for the I/O pathname.
Line 110,120: Reads the present status of output 1 into the variable Sts.
Line 130: Returns the value of bit position 0 of Sts.

Service Request and Serial Poll

The fault and mask registers, when used in conjunction with the service request and serial poll functions, allow you to select which conditions can cause computer interrupts. The fault and mask registers can also be used independently of the serial poll or service request if so desired. The following example shows how to enable an interrupt to the computer in the case of an overvoltage condition. After the interrupt has occurred, this example includes an interrupt routine that conducts a serial poll to determine on which output the overvoltage occurred. Note that this example assumes that terminal block external OV trip lines are not wired together.

```
10 ASSIGN @Ps TO 705
20 COM /Ps/ @Ps
30 OUTPUT @Ps;"CLR;UNMASK1,8;UNMASK2,8;SRQ1"
40 ON INTR 7,1 CALL Err _ trap
50 ENABLE INTR 7;2
60 OUTPUT @Ps;"OVSET1,4;OVSET2,4"
70 OUTPUT @Ps;"VSET1,5;VSET2,5"
80 Lbl: GOTO Lbl
90 END
100 !
110 !
120 SUB Err _ trap
130 OFF INTR
140 COM /Ps/ @Ps
150 IF BIT(SPOLL(@Ps),0) THEN
160 OUTPUT @Ps;"OUT1,0;OVRST1"
170 PRINT "OVERVOLTAGE ON OUTPUT #1"
180 END IF
190 IF BIT(SPOLL(@Ps),1) THEN
200 OUTPUT @Ps;"OUT2,0;OVRST2"
210 PRINT "OVERVOLTAGE ON OUTPUT #2"
220 END IF
230 OUTPUT @Ps;"FAULT?1;FAULT?2"
240 SUBEND
```

LINE 10: Assigns the I/O pathname to the power supply.

LINE 20: Declares a common block for the I/O pathname. The COM statement must be used for the @Ps variable to preserve its value for use in the service routine.

LINE 30: Returns the power supply to its power on state, un.masks output 1's and output 2's OV status bits to generate faults, and enables the service request capability on all outputs.

LINE 40: Defines interrupt at interface 7, with GP-IB priority 1.

LINE 50: Enables interrupt at interface 7 for service request type interrupts only.

LINE 60: Sets the overvoltage of outputs 1 and 2 to 4 volts.

LINE 70: Sets the voltage of outputs 1 and 2 above the OV setting so that both outputs will overvoltage when the program is run.

LINE 80: Waits for the computer to receive the interrupt. This simulates conditions that would normally exist when a program is running.

LINE 120: Defines the error handling routine.

LINE 130: Disables interrupt capability while processing.

LINE 140: Brings in the common block for the I/O pathname.

LINE 150-180: Conducts a serial poll. If bit 0 in serial poll register indicates a fault for output 1, output 1 is disabled and the overvoltage circuit is reset.

LINE 190-220: Checks bit 1 in serial poll register for a fault on output 2. If true, output 2 is disabled and the overvoltage circuit is reset.

LINE 230: Reads fault registers to clear FAU bits in serial poll register.

Error Detection

The power supply can recognize programming errors and can inform you when a programming error occurs. When an error is detected, no attempt is made to execute the command. Instead, a bit in the serial poll register is set. If SRQ2 or SRQ3 is set, an interrupt will be generated. The following program checks for programming errors and can be entered and run as is. While it is running, commands can be sent to the power supply from the keyboard. If the ERROR annunciator on the power supply's front panel indicates that an error has been detected, depress the labeled softkey to display the error on your computer screen.

```
10 ASSIGN @Ps TO 705
20 COM /Ps/ @Ps
30 ON KEY 0 LABEL "ERROR?" CALL Err_trap
40 Lbl: GOTO Lbl
50 END
60 !
70 !
80 SUB Err _ trap
90 OFF KEY
100 COM /Ps/ @Ps
110 OUTPUT @Ps;"ERR?"
120 ENTER @Ps:Err
130 OUTPUT 2 USING "#,K";CHR$(255)&CHR$(75)
140 IF Err THEN
150 PRINT "POWER SUPPLY PROGRAMMING ERROR:"
160 END IF
170 SELECT Err
180 CASE 0
190 PRINT "NO ERROR OCCURRED"
200 SUBEXIT
210 CASE 1
220 PRINT "INVALID CHARACTER"
230 CASE 2
240 PRINT "INVALID NUMBER"
250 CASE 3
260 PRINT "INVALID STRING"
270 CASE 4
280 PRINT "SYNTAX ERROR"
290 CASE 5
300 PRINT "NUMBER OUT OF RANGE"
310 CASE 6
320 PRINT "DATA REQUESTED WITHOUT QUERY"
330 CASE 7
340 PRINT "STRING EXCEEDS DISPLAY LENGTH"
350 CASE 8
360 PRINT "NUMBER TOO LARGE FOR INPUT BUFFER"
370 CASE 28
380 PRINT "INVALID CHARACTERS IN STRING"
390 CASE ELSE
400 PRINT "UNRECOGNIZED ERROR NUMBER"; Err
410 END SELECT
420 PRINT "RE-ENTER STATEMENT AND TRY AGAIN"
430 SUBEND
```

LINE 10: Assigns the I/O path name to the power supply.
 LINE 20: Declares a common block for the I/O path name.
 LINE 30: Defines interrupt on softkey depression and branch to error routine.
 LINE 40: Idles on softkey definition.
 LINE 80: Defines subprogram Err _ trap
 LINE 90: Disables interrupt capability while processing.
 LINE 100: Brings in the common block for the I/O pathname.
 LINE 110,120: Enters error code from power supply.
 LINE 130: Clears computer screen.
 LINE 140,150: If an error occurred, print message.
 LINE 170-420: Prints message based on error code. Prompt user to try again. If no error occurred, print message saying no error occurred.

Stored Operating States

Your power supply has registers that can store up to 11 operating states (note registers 0-3 are non-volatile, see Chapter 3). These states can be recalled in arbitrary order. Storing a state involves taking a "snapshot" of the voltage and current settings that are in effect when the command is received. The following example uses stored operating states to set up an output. Using this method of setting up outputs saves processing time and facilitates repeating the same commands.

```

10 ASSIGN @Ps TO 705
20 OUTPUT @Ps;"OUT1,0;OUT2,0"
30!
40 OUTPUT @Ps;"VSET1,1;ISET1,0.01;VSET2,5;ISET2,0.01;STO1"
50 OUTPUT @Ps;"VSET1,2;ISET1,0.02;VSET2,4;ISET2,0.02;STO2"
60 OUTPUT @Ps;"VSET1,3;ISET1,0.03;VSET2,3;ISET2,0.03;STO3"
70 OUTPUT @Ps;"VSET1,4;ISET1,0.04;VSET2,2;ISET2,0.04;STO4"
80 OUTPUT @Ps;"VSET1,5;ISET1,0.05;VSET2,1;ISET2,0.05;STO5"
90 !
100 OUTPUT @Ps;"CLR"
110 FOR State = 1 to 5
120 OUTPUT @Ps;"RCL";State
130 WAIT 2
140 NEXT State
150 END
  
```

LINE 10: Assigns the I/O pathname to the power supply.
 LINE 20: Disables Output 1 and Output 2.
 LINE 40-80: Stores 5 operating states for Output 1 and Output 2 in storage registers 1 through 5. Outputs not explicitly programmed will store the settings that are in effect when the store command is received.
 LINE 100: Clears the supply. All outputs are enabled and set the initial power on state.
 LINE 110-140: Loops through the sequence of five states with a two second wait between states.

Command Summary

Introduction

For convenience, a “quick reference” listing tabulating general command headers, and calibration command headers is shown at the beginning of Table C-1 (page 110). (Note that calibration commands are described in detail in Appendix A.) Table C-2 (pages 111-115) provides an alphabetical listing and a brief description of each command that may be sent to the power supplies. Chapter 5 gives a complete description (including syntax) of most of the commands listed.

All of the commands can be executed remotely over the GP-IB. Many of the commands may also be executed locally from the supply's front panel (marked by single asterisks in Table C-1).

Several commands will generate a response which will be indicated on the front panel of the supply. These commands are indicated by double asterisks in Table C-1.

Command headers are accepted in upper or lower case letters although only upper case letters are used in this summary. The brackets < > indicate a number to be sent.

Note that <ch> must specify an output channel number from 1 through 4 as applicable. Commas or spaces are required between numbers. Spaces are optional between the command header and the first number. Use semicolons between multiple commands sent in one statement.

Table C-1 Quick Reference Listing of Commands

General Commands

ASTS? < ch >	* OUT < ch >, < 1 (on) or 0 (off) >
CLR	** OUT? < ch >
CMODE < 1 (on) or 0 (off) >	* OVRST < ch >
CMODE?	OVSET < ch > < x >
DCPON < 1 (on) or 0 (off) >	** OVSET? < ch >
DLY < ch >, < delay time >	PON < 1 (on) or 0 (off) >
DLY? < ch >	PON?
DSP < 1 (on) or 0 (off) >	* RCL < register >
DSP < "string" >	ROM?
DSP?	SRQM? < ch >
* ERR?	SRQ < x >
FAULT? < ch >	** SRQ?
ID?	STO < register >
IOUT? < ch >	STS? < ch >
* IRSET < ch >, < x >	TEST?
** IRSET? < ch >	UNMASK < ch >, < sum of bit weights >
* ISET < ch >, < current setting >	UNMASK? < ch >
** ISET? < ch >	** VOUT? < ch >
ISTEP < ch >, < step value >	** VRSET < ch >, < x >
METER < ch >	** VRSET? < ch >
** METER?	VSET < ch >, < voltage setting >
OCP < ch >, < 1, (on) or 0 (off) >	** VSET? < ch >
** OCP? < ch >	VSTEP < ch >, < step value >
* OCRST < ch >	

Calibration Commands

IDATA < ch >, < llo >, < ihi >	NIDAT < ch >, < llo >, < ihi >
IHI < ch >	OVCAL < ch >
ILO < ch >	VDATA < ch >, < VLo >, < Vhi >
IRDAT < ch >, < llo >, < ihi >	VHI < ch >
IRHI < ch >	VLO < ch >
IRLO < ch >	VRDAT < ch >, < Vlo >, < Vhi >
IRLN < ch >	VRHI < ch >
IRHN < ch >	VRLO < ch >

Service Commands

IDAC < ch >, < x >	VDAC < ch >, < x >
IDAC? < ch >	VDAC? < ch >
RDAC < ch >, < x >	VMUX? < ch >
RDAC? < ch >	

*. = Command can be executed from the front panel.

** = Data returned from these commands is also displayed on the front panel after command is issued. Note that the display must be enabled (i.e. DSP = 1).

Table C-2 Command Summary

ASTS? < ch >	Queries the accumulated status (ASTS) of the specified output < ch > . The response (integer 0-255) represents the sum of the binary weights of the ASTS register bits (see page 77). The ASTS register is automatically set to the present status after being queried.
CLR	Returns the entire power supply (all outputs) to the power on state, except that the supply is not unaddressed and its store/recall registers are not changed (see page 76).
CMODE < on/off >	Turns the calibration mode on or off. On/off is a 1 to turn the calibration mode on; a 0 turns it off (see Appendix A).
CMODE?	Queries if the calibration mode is on or off. Response is either a 1 (on) or 0 (off), (see page 82).
DCPON < on/off >	Sets the state of the outputs at power-on. For on/off = 0, all outputs will be off when the power supply is turned on. For on/off = 1 all outputs will be on when the power supply is turned on.
DLY < ch >, < x >	Sets the reprogramming delay time (x) for the specified output < ch > . This delay is used to mask the CV, + CC, - CC, and UNR status bits from the fault register and the OCP function for the specified delay period (0 to 32 seconds). The delay time is initiated after a VSET, ISET, OUT, RCL, over voltage reset, or over current reset commands is sent (see page 81).
DLY? < ch >	Queries the present reprogramming delay of the specified output <ch> (see page 81). The response can be a real number from 0.000 to 32 seconds (e.g. 0.450 seconds).
DSP < on/off >	Turns the power supply's front panel display either on or off (see page 81). On/off equals 1 to turn the display on or a 0 to turn it off.
DSP?	Queries the present status of the display (see page 81). Response is either a 1 (on), or a 0 (off).
DSP "xxxxxxxxxxxx"	Puts the quoted string on the power supply's front panel display (see page 81). Only numerals, upper case letters, and spaces are allowed (12 characters max) in the quoted string.
ERR?	Queries the present programming or hardware error (see page 82). An error code number is returned over the GP-IB to identify the error. In the local mode, pressing the error key will cause the appropriate error message (not the error code) to be displayed on the front panel. The error register is cleared after being read.
FAULT? < ch >	Queries the fault register of the specified output < ch > (see page 77) . A bit is set in the fault register when the corresponding bit is set in both the status and the mask registers. The response is an integer 0 to 255. The fault register is cleared after being read.
IDAC < ch >, < x >	Programs the current DAC to a specified number of counts < x > for the selected channel < ch > . The number returned is in DAC counts.
IDAC? < ch >	Queries the LSB setting of the current DAC for the selected channel < ch > . The number returned is in DAC counts.

Table C-2 Command Summary (continued)

ID?	Queries the identification (model number) of the supply. (see page 82).
IDATA < ch >, < Ilo >, < Ihi >	Sends data to calibrate the current setting circuits of the specified output < ch >. Ilo and Ihi are measured values which the supply uses to calculate correction constants (see Appendix A).
IHI < ch >	Causes the current of the specified output < ch > to go to the high calibration point (see Appendix A).
ILO < ch >	Causes the current of the specified output < ch > to go to the low calibration point (see Appendix A).
IOUT? < ch >	Queries the measured output current of the specified output < ch > (see page 73). The response is a real number. The front panel display can be used to monitor the measured output current (and voltage) of the selected output < ch >.
IRDAT < ch >, < Ilo >, < Ihi >	Used to calibrate the + current readback for the specified output < ch >. This command must be sent after IRHI and IRLLO commands.
IRLO < ch >	Finds the minimum + current readback value for the specified output < ch > (see Appendix A.)
IRHI < ch >	Finds the maximum + current readback value for the specified output < ch > (see Appendix A.)
IRLN <ch>	Finds the minimum - current readback value for the specified output < ch > (see Appendix A.)
IRHN <ch>	Finds the maximum - current readback value for the specified output < ch > (see Appendix A.)
IRSET < ch >, < x >	Sets the full scale current range programming for an output < ch >. The power supply will select the lowest operating range that will contain the value (x). If the present operating current of the supply is greater than the full scale range selected, the present output current will be reduced to the full scale value of the new range selected. If the current entered is larger than the highest possible range, an error message will result.
IRSET? < ch >	Queries the full scale current range setting of an output < ch > .
ISSET < ch >, < x >	Sets the current of the specified output < ch > (see page 73).
ISSET? < ch >	Queries the present current setting of the specified output < ch > (see page 73). The response is a real number.
ISTEP < ch >, < x > *	Increases or decreases an output < ch > current in steps. If the step value < x > is positive, output current will increase by the step value, if the step value is negative, the output current will decrease by the step value. Trying to step beyond the active operating range will cause a number range error.
METER < ch >	Selects which output < ch > of the supply the front panel will display.
METER?	Returns which output the supply is displaying on the front panel.

Table C-2 Command Summary (continued)

NIDAT < ch > . < Ilo > . < Ihi >	Sends data to calibrate - current readback for the selected output < ch > . This command must be sent after IRLN and IRHN commands.
OCP < ch > , < x >	Enables the over current protection circuit protection circuit for the specified output < ch > . This circuit, when enabled, causes the output to go to the off state when the output is on the + CC mode. On/off is a 1 to turn on (enable) or a 0 to turn off (disable) the circuit. (see page 75).
OCP? < ch >	Queries the over current protection circuit on/off status for the specified output < ch > (see page 75). Response is either a 1 (on) or a 0 (off). The OCP ENBLD annunciator on the front panel displays the on/off status of the OCP circuit for the selected output.
OCRST < ch >	Returns the specified output < ch > to the previous settings after it had been turned off by the over current protection circuit (see page 75).
OUT < ch > , < on/off >	Turns the specified output < ch > on or off. On/off equals 1 to turn the output on and equals 0 to turn the output off (see page 77).
OUT? < ch >	Queries whether the specified output < ch > is turned on or off (see page 77). The response is either 1 (on) or 0 (off). The front panel will display the message "DISABLED" when the selected output channel is turned off.
OVCAL < ch >	Causes the specified output < ch > to go through the overvoltage calibration routine (see Appendix A).
OVRST < ch >	Attempts to reset the overvoltage crowbar circuit in the specified output < ch > (see page 77).
OVSET < ch > , < x >	Sets the overvoltage trip point < x > for the specified output < ch > (see page 77).
OVSET? < ch >	Queries the present overvoltage setting of the specified output < ch > (see page 77). The response is a real number.
PON < on/off >	Enables the power on service request (SRQ). On/off = 1 causes the power supply to generate a service request when power is applied (see page 80). On/off = 0 disables the PON SRQ. The on/off settings is retained in the supply's memory through interruption of ac line power.
PON?	Queries the present state of the power on SRQ function (see page 80). The response is either 1 (on) or 0 (off).
RCL < x >	Recalls the voltage and current settings for all output channels from the specified internal register < x > . These settings were previously stored using the STO command. RCL programs all output channels in sequential order (1, 2, 3, 4) to these stored settings (see page 80).
RDAC < ch > , < counts >	Sets the readback DAC of an output < ch > to a specified number of counts.
RDAC? < ch >	Queries the setting of the readback DAC of an output < ch > . The number returned is in DAC counts.

Table C-2 Command Summary (continued)

ROM?	Queries the revision date of the power supply's firmware. See service manual.
SROM?	Queries the revision date of the secondary ROM. See service manual.
SRQ <X>	Sets the causes for generating SRQ. Setting < x > can be a 0, 1, 2, or 3 as described on page 79.
SRQ?	Queries the present setting of the reasons for issuing an SRQ (see page 79). Response is 0, 1, 2, or that corresponds with the settings for SRQ.
STO < x >	Stores the present operating state of all outputs in one of eleven (0-10) registers < x > . Register 0 will store values of: VSET, VRSET, ISET, IRSET, OVSET, OCP, DLY, and MASK. Registers 1-10 will store values of: VSET, VRSET, ISET, IRSET, and OVSET. Registers 1 - 3 are contained in the EEPROM (U230) and are non-volatile. Registers 6-10 are located in RAM (U207) and are volatile. Whenever the supply is powered up, it initializes all outputs using the values stored in register 0. STO <0,1,2,3> can only be sent once. An error will result if an attempt is made to store more than once into each location. The supply must be cycled ON/OFF to re-enable.
STS? < ch >	Queries the present status of the specified output < ch > . The response (integer 0-255) represents the sum of the binary weights of the status register bits (see page 76).
TEST?	Causes the power supply to perform a self test of its GP-IB interface. The response is 0 if the test passes or an integer failure code (see page 82).
UNMASK < ch >, < x >	Sets the bits in the mask register of the specified output channel to the setting (integer from 0 to 255). The mask register operates in conjunction with the status and fault registers (see page 78).
UNMASK? < ch >	Queries the present setting of the mask register of the specified output channel (see page 77). The response is an integer from 0 to 255.
VDAC < ch >, < x >	Programs the voltage DAC to a specified number of counts < x > for the selected channel < ch >.
VDAC? < ch >	Queries the LSB setting of the voltage DAC for the selected channel < ch >. The number returned is in DAC counts.
VDATA< ch >, < Vlo >, < Vhi >	Sends data to calibrate the voltage setting circuits of the specified output < ch > . Vlo and Vhi are measured values which the supply uses to calculate correction constants (see Appendix A).
VHI <ch>	Causes the voltage of the specified output < ch > to go to the high calibration point (see Appendix A).
VLO < ch >	Causes the voltage of the specified output < ch > to go to the low calibration point (see Appendix A).

Table C-2 Command Summary (continued)

VMUX? < ch > , < x >	Queries the measurement of the input < x > to the analog multiplexer on the specified output < ch > (see Appendix A).
VOUT? < ch >	Queries the measured output voltage of the specified output < ch > (see page 70). The response is a real number. The front panel display can be used to monitor the measured output voltage (and current) of the selected output channel.
VRDAT < ch > , < Vlo > , < Vhi >	Used to calibrate the voltage readback for the specified output < ch > . This command must be sent after VRHI and VRLO commands.
VRLO < ch >	Finds the minimum voltage readback value for the specified output < ch > .
VRHI < ch >	Finds the maximum voltage readback value for the specified output < ch > .
VRSET < ch > , x	Sets the full scale voltage range for programming an output < ch > . The power supply will select the lowest operating range that will contain the value (x). If the present operating voltage of the supply is greater than the full scale range selected, the present output voltage will be reduced to the full scale value of the new range. If the voltage entered is larger than the highest possible range, an error message will result.
VRSET < ch >	Queries the full scale voltage range setting of an output < ch > .
VSET < ch > , < x >	Sets the voltage of the specified output < ch > (see pages 71-72).
VSET? < ch >	Queries the present voltage setting of the specified output < ch > (see page 72). The response is a real number.
VSTEP < ch > , < x >	Increases or decreases an output's < ch > voltage in steps. If the step value < x > is positive, the output voltage will increase by step value; if the step value is negative, the output voltage will decrease by the step value. Trying to step beyond the active operating range will cause a number range error.

Error Codes and Messages

Introduction

This appendix describes the GP-IB error codes that can be readback to the controller and the error messages that can be displayed on the power supply's front panel. A brief explanation of each code and message is also given. The error codes and/or messages fall into three categories: Power-on Self Test Messages, responses to the ERR? query, and responses to the TEST? query.

Power-On Self Test Messages

The applicable message listed in Table D-1 is displayed on the supply's front panel if the corresponding function has failed the power-on self test. No error code numbers can be returned for these errors. If any of these error messages appear, refer to the Troubleshooting section in the Service Manual.

Error Responses

Table D-2 describes the error codes and messages that can be generated for various programming, calibration, and hardware errors. The error codes can be read back over the GP-IB in response to the ERR? query. The applicable error message is displayed on the supply's front panel when the ERR key is pressed. Sending the ERR? or pressing the ERR key clears the error.

Test Responses

Table D-3 describes the codes that can be read back over the GP-IB in response to the TEST? query. The TEST? query initiates a self test of the supply.

Table D-1. Power-On Self Test Error Messages

Message	Explanation
TIMER FAILED	The timer on the GP-IB board failed.
8291 FAILED	GP-IB control chip on the GP-IB board failed.
CV DAC CH < ch >	The voltage DAC on the specified output board failed.
CC DAC CH < ch >	The current DAC on the specified output board failed.
OV DAC CH < ch >	The overvoltage DAC on the specified output board failed.
FUSE CH < ch >	The return fuse on the specified output board is opened.
HDW ERR CH < ch >	The specified output board is down (no output).

Table D-2. ERROR Responses

Error Code (ERR? query)	Message (ERR key)	Explanation
0	NO ERROR	Indicates there are no errors.
1	INVALID CHAR	You sent the supply a character it did not recognize.
2	INVALID NUM	The format of your number is incorrect. Check syntax (see Chapter 5).

Table D-2. ERROR Responses (continued)

Error Code (ERR? query)	Message (ERR key)	Explanation
3	INVALID STR	You sent a command the supply does not understand. Resend recognizable command.
4	SYNTAX ERROR	You sent a command with improper syntax. Check syntax of your command (see Chapter 5).
5	NUMBER RANGE	An out of range number was sent. Send a new number within the legal range.
6	NO QUERY	The computer addressed the supply to talk, but it did not first request data. Send query first and then address the supply to talk.
7	DISP LENGTH	Quoted string in the DSP command exceeds the display length of 12 characters.
8	BUFFER FULL	May occur if too many numbers are sent. Error code 4 or error code 5 are more likely to occur for this condition.
9	EEPROM ERROR	The EEPROM on the GP-IB board is not responding correctly to programming commands. An instrument failure has occurred and service is required. Refer to the Troubleshooting Section in the Service Manual.
10	HARDWARE ERR	An output error has occurred on an unknown output. Service is required. Refer to the Troubleshooting Section in the Service Manual.
11	HDW ERR CH 1	Error codes 11 through 14 refer to a specific output where an output error has occurred. Service is required. Refer to the Output Board Troubleshooting Section in the Service Manual.
12	HDW ERR CH 2	Same as in error 11.
13	HDW ERR CH 3	Same as in error 11.
14	HDW ERR CH 4	Same as in error 11.
15	NO MODEL NUM	The supply's model number cannot be found. The GP-IB Interface board may be defective or the supply may require reprogramming. Refer to the Troubleshooting Section in the Service Manual.
16	CAL ERROR	An error has occurred during calibration. This may be the result of out of range numbers sent. If recalibration (see Appendix A) does not fix this there may be a hardware failure (Refer to the Troubleshooting Section in the Service Manual).
17	UNCALIBRATED	Unexplained EEPROM error; possibly as the result of incorrect calibration procedure. Recalibrate as described in Appendix A. If the problem persists, a hardware failure exists (Refer to the Troubleshooting Section in the Service Manual)

Table D-2. ERROR Responses (continued)

Error Code (ERR? query)	Message (ERR key)	Explanation
18	CAL LOCKED	Calibration was attempted with the calibration jumper on the GP-IB board in the lockout position (See Section IV in the Service Manual). Reposition the jumper and re-calibrate if this is desired.
22	SKIP SLF TST	The self test jumper on the GP-IB board is in the Skip Self Test Position (See Section IV in the Service Manual). Reposition the jumper and carry out self-test if this is desired.

Table D3. TEST? Response

Response Code (TEST? query)	Explanation
0	No errors were detected.
20	The timer on the GP-IB board failed self test. Refer to the Troubleshooting Section in the Service Manual.
21	The RAM on the GP-IB Board failed self test. Refer to the Troubleshooting Section in the Service Manual. Note that if this failure occurred at power-on, it cannot be displayed on the front panel.
27	The RAM on the GP-IB Board failed self test. Refer to the Troubleshooting Section in the Service Manual. Note that if this failure occurred at power-on, it cannot be displayed on the front panel.
29	See Table 5-9 on page 84.
30	See Table 5-9 on page 84.

Manual Backdating

Introduction

The backdating information in this chapter applies to units that have the following serial numbers:

Agilent Model 6625A, serials 2831A-00101 to 00663

Agilent Model 6626A, serials 2831A-00101 to 00823

Agilent Model 6628A, serials 2922A-00101 to 00232

Agilent Model 6629A, serials 2920A-00101 to 00292

Make Changes

On page 29, replace the information in Line Voltage Conversion paragraph under steps number 2, 3, and 4 as follows:

2. To open the line module push against the tab on the line module in the direction of the ac input socket.
3. Remove the voltage selector card from its receptacle. This card is about one inch square and has a red notch in each of its four edges.
4. To select a voltage, insert the card into its receptacle so that after the door is closed, the red notch shows through the window next to the voltage level you require.

CAUTION

It is possible to insert the voltage selector card so that a red notch is not visible through any of the four windows. Do NOT operate the power supply while the selector card is in this position.

Also on page 28, replace figure 2-3 with the following figure;

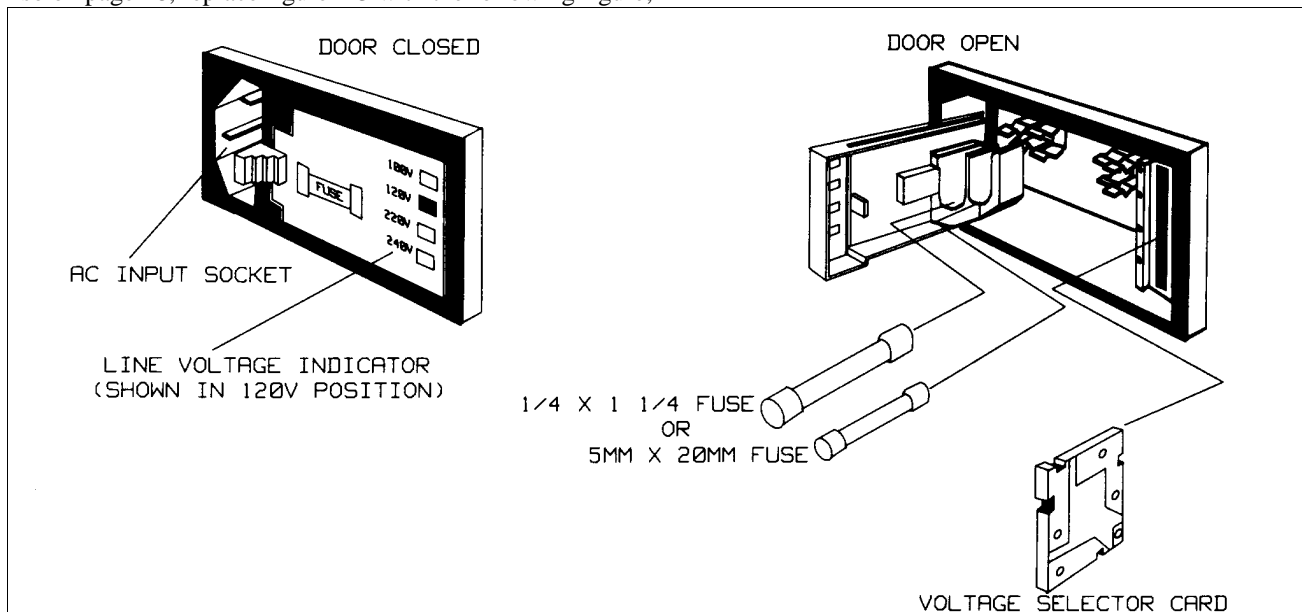

Figure 2-3. Line Module Detail

Agilent Sales and Support Office

For more information about Agilent Technologies test and measurement products, applications, services, and for a current sales office listing, visit our web site: <http://www.agilent.com/find/tmdir>

You can also contact one of the following centers and ask for a test and measurement sales representative.

United States:

Agilent Technologies
Test and Measurement Call Center
P.O. Box 4026
Englewood, CO 80155-4026
(tel) 1 800 452 4844

Latin America:

Agilent Technologies
Latin American Region Headquarters
5200 Blue Lagoon Drive, Suite #950
Miami, Florida 33126
U.S.A.
(tel) (305) 267 4245
(fax) (305) 267 4286

Canada:

Agilent Technologies Canada Inc.
5150 Spectrum Way
Mississauga, Ontario
L4W 5G1
(tel) 1 877 894 4414

Australia/New Zealand:

Agilent Technologies Australia Pty Ltd
347 Burwood Highway
Forest Hill, Victoria 3131
(tel) 1-800 629 485 (Australia)
(fax) (61 3) 9272 0749
(tel) 0 800 738 378 (New Zealand)
(fax) (64 4) 802 6881

Europe:

Agilent Technologies
Test & Measurement European Marketing Organisation
P.O. Box 999
1180 AZ Amstelveen
The Netherlands
(tel) (31 20) 547 9999

Asia Pacific:

Agilent Technologies
24/F, Cityplaza One, 1111 King's Road,
Taikoo Shing, Hong Kong
tel: (852)-3197-7777
fax: (852)-2506-9284

Japan:

Agilent Technologies Japan Ltd.
Measurement Assistance Center
9-1, Takakura-Cho, Hachioji-Shi,
Tokyo 192-8510, Japan
(tel) (81) 426 56 7832
(fax) (81) 426 56 7840

Technical data is subject to change.

Manual Updates

The following updates have been made to this manual since the print revision indicated on the title page.

2/01/00

All references to HP have been changed to Agilent.
All references to HP-IB have been changed to GPIB.