



# FrameLink Express™

## User's Manual

**CONFIDENTIAL NOTICE:**

Copyright ©2008, Imperx, Inc. All rights reserved.  
Any unauthorized use, duplication or distribution of this document or any part thereof,  
without the prior written consent of Imperx Corporation is strictly prohibited.

## Revision History

| Revision History |              |         |   |
|------------------|--------------|---------|---|
| RA01             | Aug-12-2008  | J. Egri | Initial Release   |
| RA02             | Nov-24-2008  | J. Egri | Updated Table 2a for 'unpacked' modes and added Tables 2b thru 2e for 'packed' modes.<br>Updated 'Camera Parameters' dialog to include 'packed' option.<br>Updated 'Statistics' dialog to include clock_rate, horiz. and vert. fields |
| RA03             | Dec-04-2008  | J. Egri | Updated Appendix A.   |
| RA04             | June-24-2009 | J. Egri | Updated Software Installation to reflect new InstallShield for Windows 64 bit OS.   |
| RA05             | July-12-2011 | J. Egri | Added Medium mode support.<br>Added PCIe and ExpressCard/34 versions.   |
| RA06             | Jan-30-2012  | J. Egri | Updated 'Camera Parameters' dialog to include 'TrueSense' option.   |
| RA07             | Oct-25-2012  | J. Egri | Added VCE-CLPCIe02 card and features: PoCL, GPIO and PLC.   |
| RA08             | Oct-22-2013  | J. Egri | Modified PoCL and Statistics dialogs.   |
| RA09             | Jan-28-2014  | J. Egri | Modified PoCL dialog for dual channel operation and Statistics dialog for PCI Express status.   |

# Table Of Contents

|  |           |
|--|-----------|
| <b>CHAPTER 1 - INTRODUCTION.....</b>                   | <b>7</b>  |
| FRAMELINK EXPRESS.....                                 | 8         |
| WHAT YOU NEED TO GET STARTED.....                      | 22        |
| INSPECTING THE FRAMELINK EXPRESS PACKAGE .....         | 23        |
| <b>CHAPTER 2 – HARDWARE INSTALLATION .....</b>         | <b>24</b> |
| <b>CHAPTER 3 – SOFTWARE INSTALLATION .....</b>         | <b>25</b> |
| SOFTWARE SUITE .....                                   | 25        |
| SOFTWARE INSTALLATION FROM CD .....                    | 27        |
| SOFTWARE UPGRADE FROM WEB SITE.....                    | 31        |
| FIRMWARE UPGRADE FROM WEB SITE.....                    | 32        |
| <b>CHAPTER 4 – USING THE FRAMELINK EXPRESS .....</b>   | <b>33</b> |
| RUNNING THE FRAMELINK EXPRESS APPLICATION.....         | 34        |
| MAIN WINDOW .....                                      | 35        |
| CAMERA PARAMETERS DIALOG .....                         | 40        |
| CC CONTROL DIALOG.....                                 | 46        |
| RGB CONTROL DIALOG .....                               | 49        |
| CAPTURE SETTINGS DIALOG .....                          | 50        |
| TERMINAL DIALOG.....                                   | 60        |
| STATISTICS DIALOG .....                                | 61        |
| HEX PIXEL DUMP WINDOW.....                             | 63        |
| HISTOGRAM WINDOW .....                                 | 65        |
| LOOKUP TABLE DIALOG.....                               | 73        |
| ZOOM MENU .....  | 74        |
| PLAYER CONTROL.....                                    | 75        |
| PLAYER DIALOG.....                                     | 77        |
| <b>CHAPTER 5 – ELECTRICAL INTERFACES.....</b>          | <b>78</b> |
| CAMERA LINK CONNECTOR .....                            | 79        |
| EXPRESSCARD CONNECTOR ( VCE-CLEX01/CLEX02 ONLY ) ..... | 80        |
| PCIe x1 CONNECTOR ( VCE-CLPCIe01/CLPCIe02 ONLY ).....  | 81        |
| I/O CONNECTOR ( VCE-CLPCIe02 ONLY ).....               | 82        |
| <b>CHAPTER 6 - SPECIFICATIONS.....</b>                 | <b>83</b> |
| <b>APPENDIX A – SERIAL COMMUNICATIONS .....</b>        | <b>84</b> |
| <b>APPENDIX B – CREATING LOOK UP TABLES.....</b>       | <b>85</b> |
| <b>APPENDIX C – PROGRAMMABLE LOGIC CONTROLLER.....</b> | <b>87</b> |
| COMMON DIALOG .....                                    | 88        |
| PREDEFINED METHODS .....                               | 90        |
| Method #1.....   | 91        |
| Method #2.....   | 92        |
| Method #3.....   | 93        |
| Method #4.....   | 94        |
| Method #5.....   | 95        |
| Method #6.....   | 96        |
| Method #7.....   | 97        |

|   |            |
|---|------------|
| <i>Method #8</i> .....  | 98         |
| <i>Method #9</i> .....  | 99         |
| <i>Method #10</i> .....   | 100        |
| <i>Method #11</i> .....   | 101        |
| <i>Method #12</i> .....   | 102        |
| <i>Method #13</i> .....   | 103        |
| <i>Method #14</i> .....   | 104        |
| <i>Method #15</i> .....   | 105        |
| <i>Method #16</i> .....   | 106        |
| CUSTOM METHODS .....  | 107        |
| <i>Block Diagram</i> .....  | 108        |
| <i>Input</i> .....  | 109        |
| <i>Pulse Gen</i> .....  | 111        |
| <i>Mstr/Slv</i> .....   | 113        |
| <i>Strobe</i> .....   | 116        |
| <i>Output</i> .....   | 118        |
| <i>CC</i> .....   | 119        |
| <i>Arm</i> .....  | 120        |
| <b>APPENDIX D – POWER OVER CAMERA LINK ( POCL )</b> .....           | <b>122</b> |
| <b>APPENDIX E – GENERAL PURPOSE INPUT/OUTPUT ( I/O )</b> .....      | <b>127</b> |
| GENERAL PURPOSE INPUT CIRCUIT .....                                 | 129        |
| <i>Opto-coupled Input Circuit</i> .....                             | 130        |
| <i>LVDS Input Circuit</i> .....                                     | 131        |
| <i>TTL Input Circuit</i> .....                                      | 132        |
| GENERAL PURPOSE OUTPUT CIRCUIT.....                                 | 133        |
| <i>Open Collector using Galvanic Isolation Output Circuit</i> ..... | 134        |
| <i>Open Collector using Common Ground Output Circuit</i> .....      | 135        |
| <i>Opto-Isolated Output Circuit</i> .....                           | 136        |
| <i>LVDS Output Circuit</i> .....                                    | 137        |
| <i>TTL Output Circuit</i> .....                                     | 138        |
| I/O ELECTRICAL SPECIFICATIONS.....                                  | 139        |

## Illustrations

|   |     |
|---|-----|
| Figure 1 – FrameLink Express Block Diagram .....                          | 11  |
| Figure 2a – Camera Link Interface ( connector #1 ).....                   | 12  |
| Figure 2b – Camera Link Interface ( connector #2 ).....                   | 13  |
| Figure C.1 – PLC Method #1 .....  | 91  |
| Figure C.2 – PLC Method #2 .....  | 92  |
| Figure C.3 – PLC Method #3 .....  | 93  |
| Figure C.4 – PLC Method #4 .....  | 94  |
| Figure C.5 – PLC Method #5 .....  | 95  |
| Figure C.6 – PLC Method #6 .....  | 96  |
| Figure C.7 – PLC Method #7 .....  | 97  |
| Figure C.8 – PLC Method #8 .....  | 98  |
| Figure C.9 – PLC Method #9 .....  | 99  |
| Figure C.10 – PLC Method #10 .....  | 100 |
| Figure C.11 – PLC Method #11 .....  | 101 |
| Figure C.12 – PLC Method #12 .....  | 102 |
| Figure C.13 – PLC Method #13 .....  | 103 |
| Figure C.14 – PLC Method #14 .....  | 104 |
| Figure C.15 – PLC Method #15 .....  | 105 |
| Figure C.16 – PLC Method #16 .....  | 106 |
| Figure C.17 – PLC Block Diagram .....                                     | 108 |
| Figure C.18 – PLC Input block.....  | 109 |
| Figure C.19 – PLC Pulse Generator block.....                              | 111 |
| Figure C.20 – PLC Master/Slave block .....                                | 113 |
| Figure C.21 – PLC Strobe block.....                                       | 116 |
| Figure C.22 – PLC Output block.....                                       | 118 |
| Figure C.22 – PLC CC block.....   | 119 |
| Figure C.23 – PLC ARM block.....  | 120 |
| Figure D.1 – PoCL Block Diagram .....                                     | 124 |
| Figure D.2 – PoCL Safe Power state machine.....                           | 125 |
| Figure E.1 – VCE-CLPCIe02 Daughter-card GPIO Switches.....                | 127 |
| Figure E.2 – General Purpose Input Circuit.....                           | 129 |
| Figure E.4 – Opto-coupled Input Circuit .....                             | 130 |
| Figure E.5 – LVDS Input Circuit .....                                     | 131 |
| Figure E.6 – TTL Input Circuit.....                                       | 132 |
| Figure E.3 – General Purpose Output Circuit.....                          | 133 |
| Figure E.7 – Open Collector using Galvanic Isolation Output Circuit ..... | 134 |
| Figure E.8 – Open Collector using Common Ground Output Circuit .....      | 135 |
| Figure E.9 – Opto-coupled Output Circuit .....                            | 136 |
| Figure E.10 – LVDS Output Circuit.....                                    | 137 |
| Figure E.11 – TTL Output Circuit .....                                    | 138 |

## Tables

|  |     |
|--|-----|
| Table 1 – CameraLink modes .....   | 14  |
| Table 2 – Image data bit-to-port assignments per the Camera Link specification - Base modes .....  | 15  |
| Table 3 – Image data bit-to-port assignments per the Camera Link specification - Medium modes..... | 15  |
| Table 4 – Unpacked pixel mapping into memory.....  | 16  |
| Table 5a – Packed pixel mapping into memory – 8 bit modes .....                                    | 17  |
| Table 5b – Packed pixel mapping into memory – 1x10, 2x10 and 3x10 modes – 6 pixels/DW .....        | 18  |
| Table 5c – Packed pixel mapping into memory – 4x10 mode – 12 pixels/2 DWs .....                    | 18  |
| Table 5d – Packed pixel mapping into memory – 1x12 mode – 5 pixels/DW .....                        | 19  |
| Table 5e – Packed pixel mapping into memory – 2x12 mode – 16 pixels/3 DWs .....                    | 19  |
| Table 5f – Packed pixel mapping into memory – 3x12 mode – 15 pixels/3 DWs.....                     | 19  |
| Table 5g – Packed pixel mapping into memory – 4x12 mode – 16 pixels/3 DWs .....                    | 19  |
| Table 5h – Packed pixel mapping into memory – RGB24 mode – 8 pixels/3 DWs.....                     | 20  |
| Table 5i – Packed pixel mapping into memory – RGB30 mode – 2 pixels/DW .....                       | 20  |
| Table 5j – Packed pixel mapping into memory – RGB36 mode – 5 pixels/3 DWs.....                     | 20  |
| Table 6 – Camera Link Connector Pin-out .....  | 79  |
| Table 7 – ExpressCard Connector Pin-out .....  | 80  |
| Table 8 – PCIe x1 Connector Pin-out .....  | 81  |
| Table 9 – I/O Connector Pin-out .....  | 82  |
| Table E.1 – GPIO IN[4:1] switch settings .....   | 128 |
| Table E.2 – GPIO OUT[4:1] switch settings .....  | 128 |
| Table E.3 – Input electrical specifications .....  | 139 |
| Table E.4 – Output electrical specifications .....   | 139 |

# Chapter

# 1

## Introduction

This chapter outlines the key features of the Imperx FrameLink Express series of Camera Link frame grabbers.



VCE-CLEX01



VCE-CLEX02



VCE-CLPCle01



VCE-CLPCle02



VCE-CLPCle03



VCE-CLPCle04

## FrameLink Express

---

The FrameLink Express frame grabber series includes six models:

Desktop cards:

VCE-CLPCIe01 - a dual-channel, low-profile PCI Express x1 card  
- supports two Base or one Medium interface.

VCE-CLPCIe02 - a dual-channel, low-profile PCI Express x1 card  
with I/O, PLC and PoCL.  
- supports two Base or one Medium interface.

VCE-CLPCIe03 - a dual-channel, low-profile PCI Express x4 card  
with I/O, PLC and PoCL.  
- supports two Base or one Medium interface.

VCE-CLPCIe04 - a single-channel, low-profile PCI Express x4 card  
with I/O, PLC and PoCL.  
- supports one Base, Medium, Full or Deca  
interface.

Laptop cards:

VCE-CLEX01 - a dual-channel ExpressCard/54 card  
- supports two Base or one Medium interface.

VCE-CLEX02 - a single-channel ExpressCard/34 card  
- supports one Base interface.

The FrameLink Express cards support either one or two Camera Link interfaces. They support single Base, dual Base/single Medium or single Base/Medium/Full/Deca modes. All cards transfer the video data to host memory via a PCI Express x1 or x4 interface. All of the cards share the same software ( i.e. application program, libraries and driver ). The remaining text in this document makes reference to a dual-channel card but note that the single-channel card is just a one channel version of this same card.



## Functionality

- Captures video data from two independent Base Camera Link interfaces or a single Medium Camera Link interface, formats this data and stores it into local FIFO's.
- Retrieves the formatted data from the FIFO's and transfers it into host memory via an intelligent scatter/gather DMA over the PCI Express interface.
- Provides a full-duplex asynchronous interface ( UART ) to/from an attached device on each Camera Link serial interface.
- Provides the host processor with the ability to configure the four discrete Camera Control signals on each Camera Link interface.
- VCE-CLPCIe02 only: Provides a comprehensive Programmable Logic Controller ( PLC ), I/O circuitry and Power over Camera Link ( PoCL ).

## Interfaces

### Camera Link interface

The FrameLink Express provides two Camera Link interfaces that follow the 'base' or 'medium' configuration, as defined in the Camera Link standard, requiring two 26 conductor connectors/cables ( refer to Figures 2a and 2b ). The 'base' configuration consists of multiplexing 28 bits of video data into 4 LVDS data streams. This data consists of 24 bits of pixel data along with 4 pixel qualifier signals: 'line valid' strobe, 'frame valid' strobe, 'data valid' strobe and a spare strobe ( for future use ). A phased-locked transmit clock is transmitted in parallel with the data streams over a fifth LVDS link. Additionally, four RS-644 LVDS streams ( CC[4:1] ) are included for general purpose camera control. These 'camera control' signals allow the frame grabber to manipulate discrete controls within an attached camera. A bi-directional asynchronous communications channel between the frame grabber and an attached camera is also provided by means of two RS-644 LVDS pairs. The 'medium' configuration consist of two 'base' configurations with the exception that the second interface does not include the general purpose camera control signals and the communications channel.

### PCI Express interface

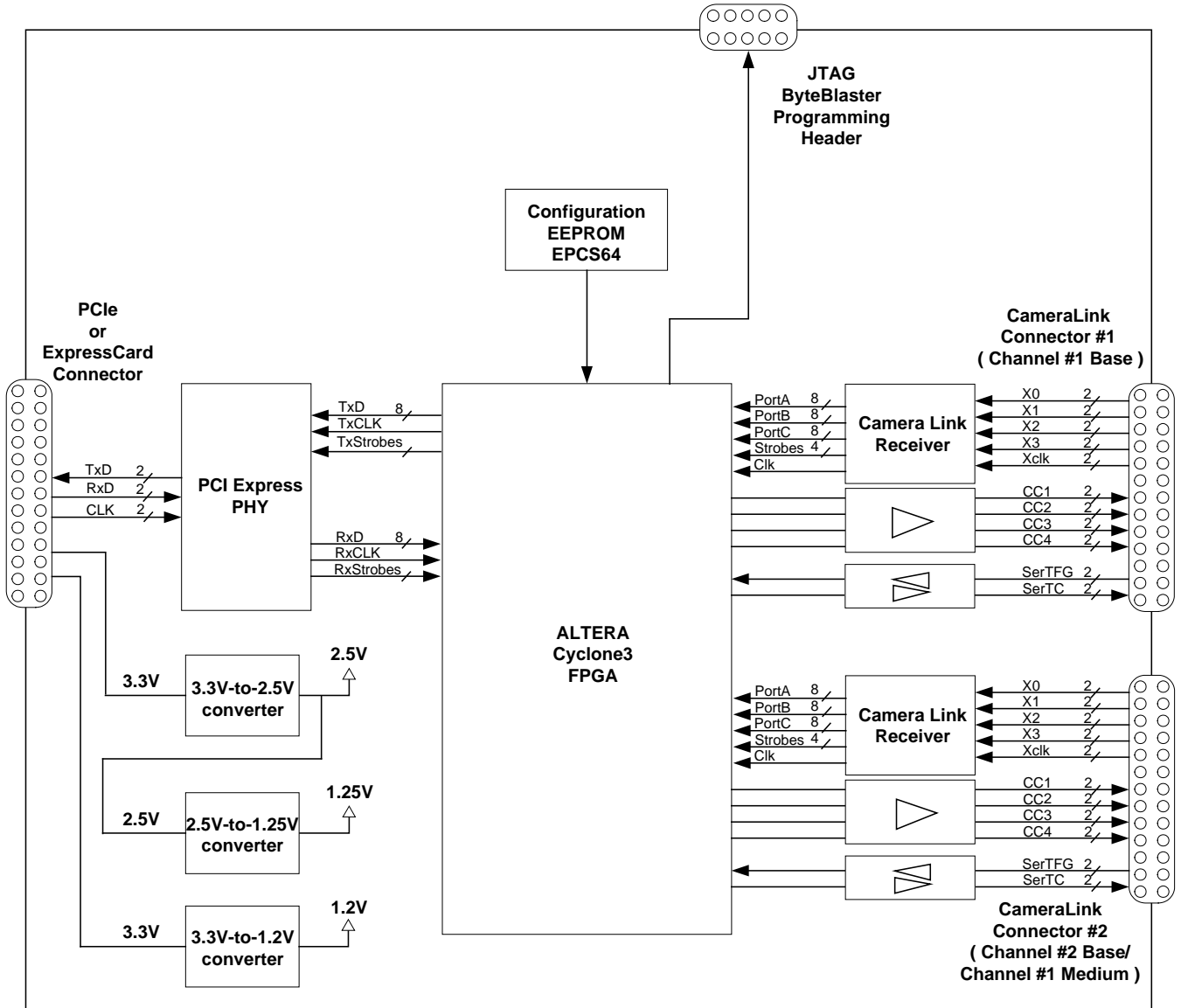
The FrameLink Express PCIe card complies with the x1 low-profile PCI Express add-in card dimensions as defined in the PCI Express Card Electromechanical Specification revision 2.0.

The FrameLink Express/54 and FrameLink Express/34 cards comply with

the ExpressCard/54 and ExpressCard/34 package dimensions, respectively, as defined in the ExpressCard Standard release 1.2. Both cards include a 37mm x 20mm extension area used to house the CameraLink connectors.

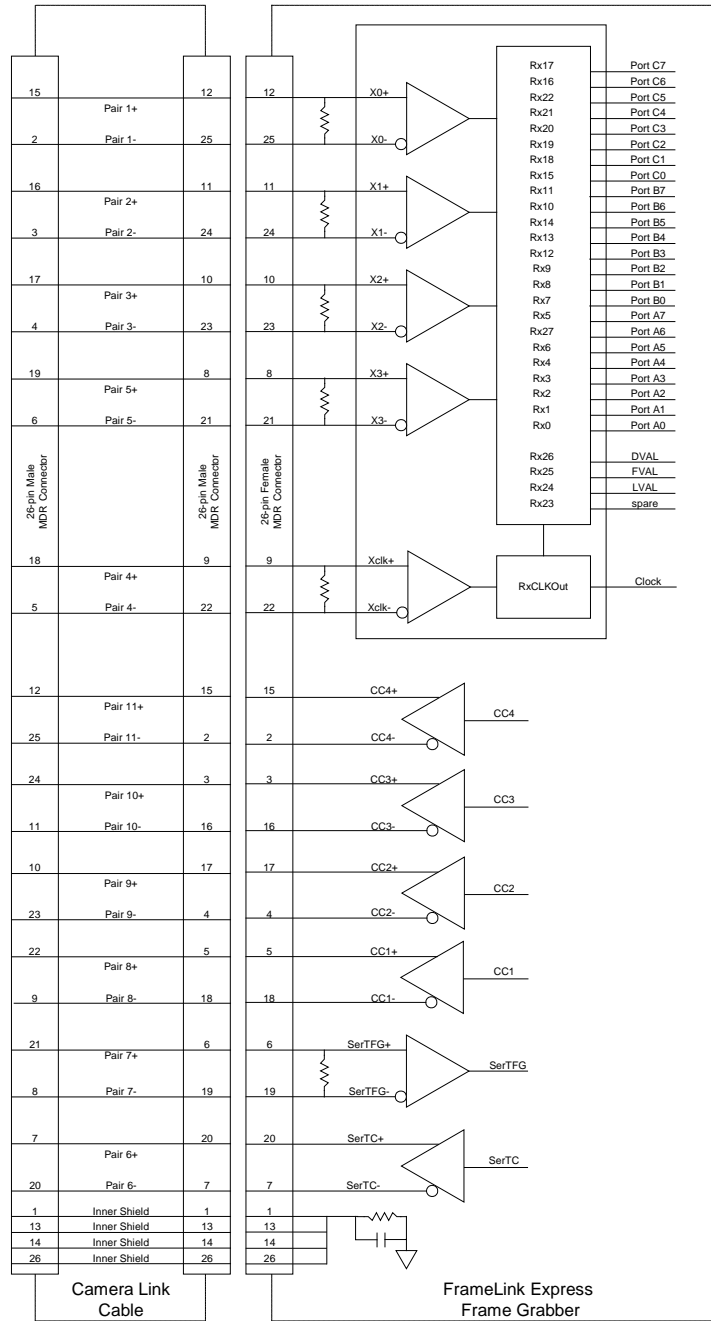
The FrameLink Express provides a 2.5 GHz PCIe Master/Target interface compliant with the PCI Express Release 1.2 specification. This interface provides a single 'function', as defined in the PCI Express specification. The design does not support any memory mapped or I/O mapped peripherals on card. Access to the FrameLink Express's FIFOs is achieved through DMA operations that move the data from the FIFOs into host memory. The host cannot directly access the contents of the FIFOs. The design supports host access into configuration registers, DMA registers, local registers and CIS data via configuration space accesses.

A functional block diagram of the FrameLink Express card is illustrated in Figure 1.

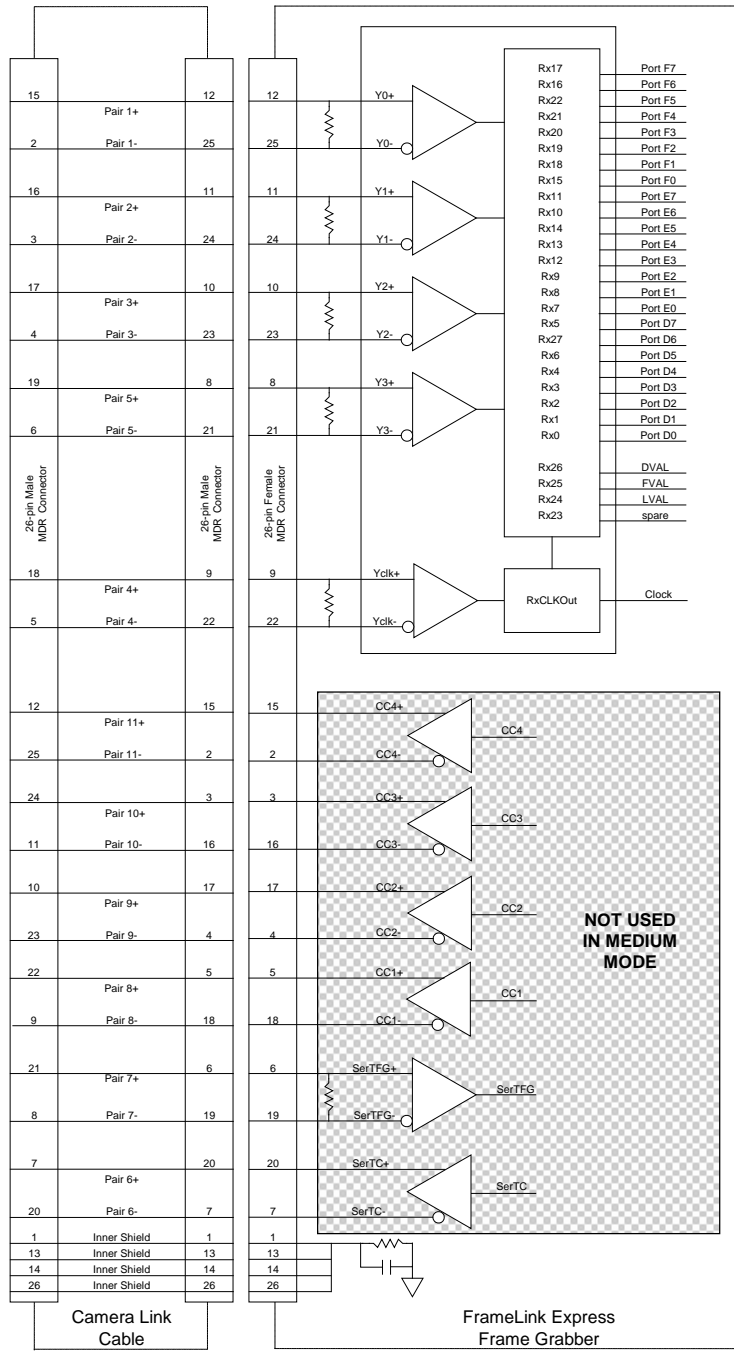


**Figure 1 – FrameLink Express Block Diagram**

A functional block diagram of the Camera Link interface is illustrated in Figures 2a and 2b.



**Figure 2a – Camera Link Interface ( connector #1)**



**Figure 2b – Camera Link Interface ( connector #2 )**

## Video Capture

The video capture engine is responsible for receiving video pixel data and qualifiers from the Camera Link transceivers, formatting the data and transferring it into on-board memory. It supports all CameraLink modes as defined in Table 1 for Base and Medium configurations. Seventeen different modes of operation are supported as indicated in the table. The data that it receives from the Camera Link transceivers, per the Camera Link specification, is illustrated in Table 2 and Table 3 for Base and Medium modes, respectively.

The video capture engine translates this data into doublewords ( 64 bits ), as defined in Table 4 and Tables 5a–5j. These tables reflect how the data will appear in host memory. Two options are provided: un-packed and packed. When ‘un-packed’ is selected, the data is formatted per Table 4. When ‘packed’ is selected, the data is formatted per Tables 5a thru 5j. Packing uses the PCI Express bandwidth more efficiently and conserves memory space.

| 1x8 | 2x8 | 3x8 | 1x10 | 2x10 | 1x12 | 2x12 | 1x14 | 1x16 | RGB24 | 4x8 | 3x10 | 4x10 | 3x12 | 4x12 | RGB30 | RGB36 | MODE   |
|-----|-----|-----|------|------|------|------|------|------|-------|-----|------|------|------|------|-------|-------|--------|
| ✓   | ✓   | ✓   | ✓    | ✓    | ✓    | ✓    | ✓    | ✓    | ✓     |     |      |      |      |      |       |       | Base   |
|     |     |     |      |      |      |      |      |      |       | ✓   | ✓    | ✓    | ✓    | ✓    | ✓     | ✓     | Medium |

**Table 1 – CameraLink modes**

| Port C |     |     |     |     |     |     |     | Port B |     |     |     |     |     |     |     | Port A |     |     |     |     |     |     |     | MODE  |    |      |
|--------|-----|-----|-----|-----|-----|-----|-----|--------|-----|-----|-----|-----|-----|-----|-----|--------|-----|-----|-----|-----|-----|-----|-----|-------|----|------|
| c7     | c6  | c5  | c4  | c3  | c2  | c1  | c0  | b7     | b6  | b5  | b4  | b3  | b2  | b1  | b0  | a7     | a6  | a5  | a4  | a3  | a2  | a1  | a0  |       |    |      |
|        |     |     |     |     |     |     |     |        |     |     |     |     |     |     |     | A7     | A6  | A5  | A4  | A3  | A2  | A1  | A0  | 1x8   |    |      |
|        |     |     |     |     |     |     |     | B7     | B6  | B5  | B4  | B3  | B2  | B1  | B0  | A7     | A6  | A5  | A4  | A3  | A2  | A1  | A0  | 2x8   |    |      |
| C7     | C6  | C5  | C4  | C3  | C2  | C1  | C0  | B7     | B6  | B5  | B4  | B3  | B2  | B1  | B0  | A7     | A6  | A5  | A4  | A3  | A2  | A1  | A0  | 3x8   |    |      |
|        |     |     |     |     |     |     |     |        |     |     |     |     |     |     |     | A9     | A8  |     |     |     |     |     |     | 1x10  |    |      |
|        |     |     |     |     |     |     |     |        |     | B9  | B8  |     |     |     |     | A9     | A8  | A7  | A6  | A5  | A4  | A3  | A2  | A1    | A0 | 2x10 |
|        |     |     |     |     |     |     |     |        |     |     |     | A11 | A10 | A9  | A8  | A7     | A6  | A5  | A4  | A3  | A2  | A1  | A0  | 1x12  |    |      |
|        |     |     |     |     |     |     |     | B7     | B6  | B5  | B4  | B3  | B2  | B1  | B0  | B11    | B10 | B9  | B8  | A11 | A10 | A9  | A8  | 2x12  |    |      |
|        |     |     |     |     |     |     |     |        |     |     |     | A13 | A12 | A11 | A10 | A9     | A8  | A7  | A6  | A5  | A4  | A3  | A2  | A1    | A0 | 1x14 |
|        |     |     |     |     |     |     |     |        |     |     |     |     |     |     |     |        |     | A15 | A14 | A13 | A12 | A11 | A10 | A9    | A8 | 1x16 |
| BL7    | BL6 | BL5 | BL4 | BL3 | BL2 | BL1 | BL0 | GR7    | GR6 | GR5 | GR4 | GR3 | GR2 | GR1 | GR0 | RD7    | RD6 | RD5 | RD4 | RD3 | RD2 | RD1 | RD0 | RGB24 |    |      |

**Table 2 – Image data bit-to-port assignments per the Camera Link specification - Base modes**

| Port C<br>Port F |     |     |     |     |     |     |     | Port B<br>Port E |    |    |    |    |    |    |    | Port A<br>Port D |      |     |     |      |      |     |     | MODE |     |     |     |     |     |     |     |       |     |       |
|------------------|-----|-----|-----|-----|-----|-----|-----|------------------|----|----|----|----|----|----|----|------------------|------|-----|-----|------|------|-----|-----|------|-----|-----|-----|-----|-----|-----|-----|-------|-----|-------|
| c7               | c6  | c5  | c4  | c3  | c2  | c1  | c0  | f7               | f6 | f5 | f4 | f3 | f2 | f1 | f0 | e7               | e6   | e5  | e4  | e3   | e2   | e1  | e0  |      | d7  | d6  | d5  | d4  | d3  | d2  | d1  | d0    |     |       |
| C7               | C6  | C5  | C4  | C3  | C2  | C1  | C0  |                  |    |    |    |    |    |    |    | B7               | B6   | B5  | B4  | B3   | B2   | B1  | B0  | A7   | A6  | A5  | A4  | A3  | A2  | A1  | A0  | 4x8   |     |       |
|                  |     |     |     |     |     |     |     |                  |    |    |    |    |    |    |    |                  |      | B9  | B8  |      |      |     |     | A9   | A8  |     |     |     |     |     |     | 3x10  |     |       |
|                  |     |     |     |     |     |     |     |                  |    |    |    |    |    |    |    |                  |      | B9  | B8  |      |      |     |     | A9   | A8  | A7  | A6  | A5  | A4  | A3  | A2  | A1    | A0  | 4x10  |
|                  |     |     |     |     |     |     |     |                  |    |    |    |    |    |    |    |                  |      | B9  | B8  |      |      |     |     | A9   | A8  | D7  | D6  | D5  | D4  | D3  | D2  | D1    | D0  | 3x12  |
|                  |     |     |     |     |     |     |     |                  |    |    |    |    |    |    |    | B11              | B10  | B9  | B8  | A11  | A10  | A9  | A8  | A7   | A6  | A5  | A4  | A3  | A2  | A1  | A0  | 4x12  |     |       |
|                  |     |     |     |     |     |     |     |                  |    |    |    |    |    |    |    | B11              | B10  | B9  | B8  | A11  | A10  | A9  | A8  | A7   | A6  | A5  | A4  | A3  | A2  | A1  | A0  | 4x12  |     |       |
|                  |     |     |     |     |     |     |     |                  |    |    |    |    |    |    |    | B11              | B10  | B9  | B8  | A11  | A10  | A9  | A8  | A7   | A6  | A5  | A4  | A3  | A2  | A1  | A0  | 4x12  |     |       |
|                  |     |     |     |     |     |     |     |                  |    |    |    |    |    |    |    | B11              | B10  | B9  | B8  | A11  | A10  | A9  | A8  | A7   | A6  | A5  | A4  | A3  | A2  | A1  | A0  | 4x12  |     |       |
| BL7              | BL6 | BL5 | BL4 | BL3 | BL2 | BL1 | BL0 |                  |    |    |    |    |    |    |    |                  |      | BL9 | BL8 |      |      |     |     | RD9  | RD8 | RD7 | RD6 | RD5 | RD4 | RD3 | RD2 | RD1   | RD0 | RGB30 |
|                  |     |     |     |     |     |     |     |                  |    |    |    |    |    |    |    |                  |      | BL9 | BL8 |      |      |     |     | RD9  | RD8 | GR7 | GR6 | GR5 | GR4 | GR3 | GR2 | GR1   | GR0 | RGB36 |
|                  |     |     |     |     |     |     |     |                  |    |    |    |    |    |    |    | BL11             | BL10 | BL9 | BL8 | RD11 | RD10 | RD9 | RD8 | RD7  | RD6 | RD5 | RD4 | RD3 | RD2 | RD1 | RD0 | RGB36 |     |       |
|                  |     |     |     |     |     |     |     |                  |    |    |    |    |    |    |    | BL11             | BL10 | BL9 | BL8 | RD11 | RD10 | RD9 | RD8 | RD7  | RD6 | RD5 | RD4 | RD3 | RD2 | RD1 | RD0 | RGB36 |     |       |

**Table 3 – Image data bit-to-port assignments per the Camera Link specification - Medium modes**

| Byte4 |     |     |     |     |     |     |     | Byte3 |     |     |     |     |     |     |     | Byte 2 |     |     |     |     |     |     |     | Byte1 |    |    |    |    |    |    |       | MODE  | Base | Med  |   |  |
|-------|-----|-----|-----|-----|-----|-----|-----|-------|-----|-----|-----|-----|-----|-----|-----|--------|-----|-----|-----|-----|-----|-----|-----|-------|----|----|----|----|----|----|-------|-------|------|------|---|--|
| d31   | d30 | d29 | d28 | d27 | d26 | d25 | d24 | d23   | d22 | d21 | d20 | d19 | d18 | d17 | d16 | d15    | d14 | d13 | d12 | d11 | d10 | d9  | d8  | d7    | d6 | d5 | d4 | d3 | d2 | d1 | d0    |       |      |      |   |  |
| A7    | A6  | A5  | A4  | A3  | A2  | A1  | A0  | A7    | A6  | A5  | A4  | A3  | A2  | A1  | A0  | A7     | A6  | A5  | A4  | A3  | A2  | A1  | A0  | A7    | A6 | A5 | A4 | A3 | A2 | A1 | A0    | 1x8   | ✓    |      |   |  |
| B7    | B6  | B5  | B4  | B3  | B2  | B1  | B0  | A7    | A6  | A5  | A4  | A3  | A2  | A1  | A0  | B7     | B6  | B5  | B4  | B3  | B2  | B1  | B0  | A7    | A6 | A5 | A4 | A3 | A2 | A1 | A0    | 2x8   | ✓    |      |   |  |
| -     | -   | -   | -   | -   | -   | -   | -   | C7    | C6  | C5  | C4  | C3  | C2  | C1  | C0  | B7     | B6  | B5  | B4  | B3  | B2  | B1  | B0  | A7    | A6 | A5 | A4 | A3 | A2 | A1 | A0    | 3x8   | ✓    |      |   |  |
| D7    | D6  | D5  | D4  | D3  | D2  | D1  | D0  | C7    | C6  | C5  | C4  | C3  | C2  | C1  | C0  | B7     | B6  | B5  | B4  | B3  | B2  | B1  | B0  | A7    | A6 | A5 | A4 | A3 | A2 | A1 | A0    | 4x8   |      | ✓    |   |  |
| -     | -   | -   | -   | -   | -   | A9  | A8  | A7    | A6  | A5  | A4  | A3  | A2  | A1  | A0  | -      | -   | -   | -   | -   | -   | -   | A9  | A8    | A7 | A6 | A5 | A4 | A3 | A2 | A1    | A0    | 1x10 | ✓    |   |  |
| -     | -   | -   | -   | -   | -   | B9  | B8  | B7    | B6  | B5  | B4  | B3  | B2  | B1  | B0  | -      | -   | -   | -   | -   | -   | -   | A9  | A8    | A7 | A6 | A5 | A4 | A3 | A2 | A1    | A0    | 2x10 | ✓    |   |  |
| -     | -   | -   | -   | -   | -   | B9  | B8  | B7    | B6  | B5  | B4  | B3  | B2  | B1  | B0  | -      | -   | -   | -   | -   | -   | -   | A9  | A8    | A7 | A6 | A5 | A4 | A3 | A2 | A1    | A0    | 3x10 |      | ✓ |  |
| -     | -   | -   | -   | -   | -   | B9  | B8  | B7    | B6  | B5  | B4  | B3  | B2  | B1  | B0  | -      | -   | -   | -   | -   | -   | -   | A9  | A8    | A7 | A6 | A5 | A4 | A3 | A2 | A1    | A0    | 4x10 |      | ✓ |  |
| -     | -   | -   | -   | A11 | A10 | A9  | A8  | A7    | A6  | A5  | A4  | A3  | A2  | A1  | A0  | -      | -   | -   | -   | -   | A11 | A10 | A9  | A8    | A7 | A6 | A5 | A4 | A3 | A2 | A1    | A0    | 1x12 | ✓    |   |  |
| -     | -   | -   | -   | B11 | B10 | B9  | B8  | B7    | B6  | B5  | B4  | B3  | B2  | B1  | B0  | -      | -   | -   | -   | -   | A11 | A10 | A9  | A8    | A7 | A6 | A5 | A4 | A3 | A2 | A1    | A0    | 2x12 | ✓    |   |  |
| -     | -   | -   | -   | B11 | B10 | B9  | B8  | B7    | B6  | B5  | B4  | B3  | B2  | B1  | B0  | -      | -   | -   | -   | -   | A11 | A10 | A9  | A8    | A7 | A6 | A5 | A4 | A3 | A2 | A1    | A0    | 3x12 |      | ✓ |  |
| -     | -   | -   | -   | B11 | B10 | B9  | B8  | B7    | B6  | B5  | B4  | B3  | B2  | B1  | B0  | -      | -   | -   | -   | -   | A11 | A10 | A9  | A8    | A7 | A6 | A5 | A4 | A3 | A2 | A1    | A0    | 4x12 |      | ✓ |  |
| -     | -   | -   | A13 | A12 | A11 | A10 | A9  | A8    | A7  | A6  | A5  | A4  | A3  | A2  | A1  | A0     | -   | -   | -   | A13 | A12 | A11 | A10 | A9    | A8 | A7 | A6 | A5 | A4 | A3 | A2    | A1    | A0   | 1x14 | ✓ |  |
| A15   | A14 | A13 | A12 | A11 | A10 | A9  | A8  | A7    | A6  | A5  | A4  | A3  | A2  | A1  | A0  | A15    | A14 | A13 | A12 | A11 | A10 | A9  | A8  | A7    | A6 | A5 | A4 | A3 | A2 | A1 | A0    | 1x16  | ✓    |      |   |  |
| -     | -   | -   | -   | -   | -   | -   | -   | RD    | RD  | RD  | RD  | RD  | RD  | RD  | RD  | GR     | GR  | GR  | GR  | GR  | GR  | GR  | GR  | BL    | BL | BL | BL | BL | BL | BL | BL    | RGB24 | ✓    |      |   |  |
| -     | -   | -   | -   | -   | -   | GR  | GR  | GR    | GR  | GR  | GR  | GR  | GR  | GR  | -   | -      | -   | -   | -   | -   | -   | BL  | BL  | BL    | BL | BL | BL | BL | BL | BL | BL    | RGB30 |      | ✓    |   |  |
| -     | -   | -   | -   | GR  | GR  | GR  | GR  | GR    | GR  | GR  | GR  | GR  | GR  | GR  | -   | -      | -   | -   | BL  | BL  | BL  | BL  | BL  | BL    | BL | BL | BL | BL | BL | BL | RGB36 |       | ✓    |      |   |  |

| Byte8 |     |     |     |     |     |     |     | Byte7 |     |     |     |     |     |     |     | Byte6 |     |     |     |     |     |     |     | Byte5 |     |     |     |     |     |     |     | MODE  | Base | Med  |   |  |
|-------|-----|-----|-----|-----|-----|-----|-----|-------|-----|-----|-----|-----|-----|-----|-----|-------|-----|-----|-----|-----|-----|-----|-----|-------|-----|-----|-----|-----|-----|-----|-----|-------|------|------|---|--|
| d63   | d62 | d61 | d60 | d59 | d58 | d57 | d56 | d55   | d54 | d53 | d52 | d51 | d50 | d49 | d48 | d47   | d46 | d45 | d44 | d43 | d42 | d41 | d40 | d39   | d38 | d37 | d36 | d35 | d34 | d33 | d32 |       |      |      |   |  |
| A7    | A6  | A5  | A4  | A3  | A2  | A1  | A0  | A7    | A6  | A5  | A4  | A3  | A2  | A1  | A0  | A7    | A6  | A5  | A4  | A3  | A2  | A1  | A0  | A7    | A6  | A5  | A4  | A3  | A2  | A1  | A0  | 1x8   | ✓    |      |   |  |
| B7    | B6  | B5  | B4  | B3  | B2  | B1  | B0  | A7    | A6  | A5  | A4  | A3  | A2  | A1  | A0  | B7    | B6  | B5  | B4  | B3  | B2  | B1  | B0  | A7    | A6  | A5  | A4  | A3  | A2  | A1  | A0  | 2x8   | ✓    |      |   |  |
| -     | -   | -   | -   | -   | -   | -   | -   | C7    | C6  | C5  | C4  | C3  | C2  | C1  | C0  | B7    | B6  | B5  | B4  | B3  | B2  | B1  | B0  | A7    | A6  | A5  | A4  | A3  | A2  | A1  | A0  | 3x8   | ✓    |      |   |  |
| D7    | D6  | D5  | D4  | D3  | D2  | D1  | D0  | C7    | C6  | C5  | C4  | C3  | C2  | C1  | C0  | B7    | B6  | B5  | B4  | B3  | B2  | B1  | B0  | A7    | A6  | A5  | A4  | A3  | A2  | A1  | A0  | 4x8   |      | ✓    |   |  |
| -     | -   | -   | -   | -   | -   | A9  | A8  | A7    | A6  | A5  | A4  | A3  | A2  | A1  | A0  | -     | -   | -   | -   | -   | -   | -   | A9  | A8    | A7  | A6  | A5  | A4  | A3  | A2  | A1  | A0    | 1x10 | ✓    |   |  |
| -     | -   | -   | -   | -   | -   | B9  | B8  | B7    | B6  | B5  | B4  | B3  | B2  | B1  | B0  | -     | -   | -   | -   | -   | -   | -   | A9  | A8    | A7  | A6  | A5  | A4  | A3  | A2  | A1  | A0    | 2x10 | ✓    |   |  |
| -     | -   | -   | -   | -   | -   | -   | -   | -     | -   | -   | -   | -   | -   | -   | -   | -     | -   | -   | -   | -   | -   | -   | C9  | C8    | C7  | C6  | C5  | C4  | C3  | C2  | C1  | C0    | 3x10 |      | ✓ |  |
| -     | -   | -   | -   | -   | -   | D9  | D8  | D7    | D6  | D5  | D4  | D3  | D2  | D1  | D0  | -     | -   | -   | -   | -   | -   | -   | C9  | C8    | C7  | C6  | C5  | C4  | C3  | C2  | C1  | C0    | 4x10 |      | ✓ |  |
| -     | -   | -   | -   | A11 | A10 | A9  | A8  | A7    | A6  | A5  | A4  | A3  | A2  | A1  | A0  | -     | -   | -   | -   | -   | A11 | A10 | A9  | A8    | A7  | A6  | A5  | A4  | A3  | A2  | A1  | A0    | 1x12 | ✓    |   |  |
| -     | -   | -   | -   | B11 | B10 | B9  | B8  | B7    | B6  | B5  | B4  | B3  | B2  | B1  | B0  | -     | -   | -   | -   | -   | A11 | A10 | A9  | A8    | A7  | A6  | A5  | A4  | A3  | A2  | A1  | A0    | 2x12 | ✓    |   |  |
| -     | -   | -   | -   | -   | -   | -   | -   | -     | -   | -   | -   | -   | -   | -   | -   | -     | -   | -   | -   | -   | C11 | C10 | C9  | C8    | C7  | C6  | C5  | C4  | C3  | C2  | C1  | C0    | 3x12 |      | ✓ |  |
| -     | -   | -   | -   | D11 | D10 | D9  | D8  | D7    | D6  | D5  | D4  | D3  | D2  | D1  | D0  | -     | -   | -   | -   | -   | C11 | C10 | C9  | C8    | C7  | C6  | C5  | C4  | C3  | C2  | C1  | C0    | 4x12 |      | ✓ |  |
| -     | -   | -   | A13 | A12 | A11 | A10 | A9  | A8    | A7  | A6  | A5  | A4  | A3  | A2  | A1  | A0    | -   | -   | -   | A13 | A12 | A11 | A10 | A9    | A8  | A7  | A6  | A5  | A4  | A3  | A2  | A1    | A0   | 1x14 | ✓ |  |
| A15   | A14 | A13 | A12 | A11 | A10 | A9  | A8  | A7    | A6  | A5  | A4  | A3  | A2  | A1  | A0  | A15   | A14 | A13 | A12 | A11 | A10 | A9  | A8  | A7    | A6  | A5  | A4  | A3  | A2  | A1  | A0  | 1x16  | ✓    |      |   |  |
| -     | -   | -   | -   | -   | -   | -   | -   | RD    | RD  | RD  | RD  | RD  | RD  | RD  | RD  | GR    | GR  | GR  | GR  | GR  | GR  | GR  | GR  | BL    | BL  | BL  | BL  | BL  | BL  | BL  | BL  | RGB24 | ✓    |      |   |  |
| -     | -   | -   | -   | -   | -   | -   | -   | -     | -   | -   | -   | -   | -   | -   | -   | -     | -   | -   | -   | -   | -   | RD  | RD  | RD    | RD  | RD  | RD  | RD  | RD  | RD  | RD  | RGB30 |      | ✓    |   |  |
| -     | -   | -   | -   | -   | -   | -   | -   | -     | -   | -   | -   | -   | -   | -   | -   | -     | -   | -   | -   | RD  | RD  | RD  | RD  | RD    | RD  | RD  | RD  | RD  | RD  | RD  | RD  | RGB36 |      | ✓    |   |  |

**Table 4 – Unpacked pixel mapping into memory**





|     |     |     |     |     |     |     |     |     |     |     |     |     |     |     |     |     |     |     |     |     |     |     |     |     |     |     |     |     |     |     |     |      |
|-----|-----|-----|-----|-----|-----|-----|-----|-----|-----|-----|-----|-----|-----|-----|-----|-----|-----|-----|-----|-----|-----|-----|-----|-----|-----|-----|-----|-----|-----|-----|-----|------|
| d31 | d30 | d29 | d28 | d27 | d26 | d25 | d24 | d23 | d22 | d21 | d20 | d19 | d18 | d17 | d16 | d15 | d14 | d13 | d12 | d11 | d10 | d9  | d8  | d7  | d6  | d5  | D4  | d3  | d2  | d1  | d0  |      |
| d63 | d62 | d61 | d60 | d59 | d58 | d57 | d56 | d55 | d54 | d53 | d52 | d51 | d50 | d49 | d48 | d47 | d46 | d45 | d44 | d43 | d42 | d41 | d40 | d39 | d38 | d37 | d36 | d35 | d34 | d33 | d32 | MODE |
| A1  | A0  | A9  | A8  | A7  | A6  | A5  | A4  | A3  | A2  | A1  | A0  | A9  | A8  | A7  | A6  | A5  | A4  | A3  | A2  | A1  | A0  | A9  | A8  | A7  | A6  | A5  | A4  | A3  | A2  | A1  | A0  | 1x10 |
| -   | -   | -   | -   | A9  | A8  | A7  | A6  | A5  | A4  | A3  | A2  | A1  | A0  | A9  | A8  | A7  | A6  | A5  | A4  | A3  | A2  | A1  | A0  | A9  | A8  | A7  | A6  | A5  | A4  | A3  | A2  |      |
| B1  | B0  | A9  | A8  | A7  | A6  | A5  | A4  | A3  | A2  | A1  | A0  | B9  | B8  | B7  | B6  | B5  | B4  | B3  | B2  | B1  | B0  | A9  | A8  | A7  | A6  | A5  | A4  | A3  | A2  | A1  | A0  | 2x10 |
| -   | -   | -   | -   | B9  | B8  | B7  | B6  | B5  | B4  | B3  | B2  | B1  | B0  | A9  | A8  | A7  | A6  | A5  | A4  | A3  | A2  | A1  | A0  | B9  | B8  | B7  | B6  | B5  | B4  | B3  | B2  |      |
| A1  | A0  | C9  | C8  | C7  | C6  | C5  | C4  | C3  | C2  | C1  | C0  | B9  | B8  | B7  | B6  | B5  | B4  | B3  | B2  | B1  | B0  | A9  | A8  | A7  | A6  | A5  | A4  | A3  | A2  | A1  | A0  | 3x10 |
| -   | -   | -   | -   | C9  | C8  | C7  | C6  | C5  | C4  | C3  | C2  | C1  | C0  | B9  | B8  | B7  | B6  | B5  | B4  | B3  | B2  | B1  | B0  | A9  | A8  | A7  | A6  | A5  | A4  | A3  | A2  |      |

**Table 5b – Packed pixel mapping into memory – 1x10, 2x10 and 3x10 modes – 6 pixels/DW**

|     |    |    |    |    |    |    |    |    |    |    |    |    |    |    |    |    |    |    |    |    |    |    |    |    |    |    |    |    |    |    |    |    |      |
|-----|----|----|----|----|----|----|----|----|----|----|----|----|----|----|----|----|----|----|----|----|----|----|----|----|----|----|----|----|----|----|----|----|------|
|     | 31 | 30 | 29 | 28 | 27 | 26 | 25 | 24 | 23 | 22 | 21 | 20 | 19 | 18 | 17 | 16 | 15 | 14 | 13 | 12 | 11 | 10 | 9  | 8  | 7  | 6  | 5  | 4  | 3  | 2  | 1  | 0  |      |
|     | 63 | 62 | 61 | 60 | 59 | 58 | 57 | 56 | 55 | 54 | 53 | 52 | 51 | 50 | 49 | 48 | 47 | 46 | 45 | 44 | 43 | 42 | 41 | 40 | 39 | 38 | 37 | 36 | 35 | 34 | 33 | 32 | MODE |
| DW1 | D1 | D0 | C9 | C8 | C7 | C6 | C5 | C4 | C3 | C2 | C1 | C0 | B9 | B8 | B7 | B6 | B5 | B4 | B3 | B2 | B1 | B0 | A9 | A8 | A7 | A6 | A5 | A4 | A3 | A2 | A1 | A0 | 4x10 |
| DW1 | C3 | C2 | C1 | C0 | B9 | B8 | B7 | B6 | B5 | B4 | B3 | B2 | B1 | B0 | A9 | A8 | A7 | A6 | A5 | A4 | A3 | A2 | A1 | A0 | D9 | D8 | D7 | D6 | D5 | D4 | D3 | D2 |      |
| DW2 | B5 | B4 | B3 | B2 | B1 | B0 | A9 | A8 | A7 | A6 | A5 | A4 | A3 | A2 | A1 | A0 | D9 | D8 | D7 | D6 | D5 | D4 | D3 | D2 | D1 | D0 | C9 | C8 | C7 | C6 | C5 | C4 |      |
| DW2 | -  | -  | -  | -  | -  | -  | -  | -  | D9 | D8 | D7 | D6 | D5 | D4 | D3 | D2 | D1 | D0 | C9 | C8 | C7 | C6 | C5 | C4 | C3 | C2 | C1 | C0 | B9 | B8 | B7 | B6 |      |

**Table 5c – Packed pixel mapping into memory – 4x10 mode – 12 pixels/2 DWs**

|     |     |     |     |     |     |     |     |     |     |     |     |     |     |     |     |     |     |     |     |     |     |     |     |     |     |     |     |     |     |     |     |      |
|-----|-----|-----|-----|-----|-----|-----|-----|-----|-----|-----|-----|-----|-----|-----|-----|-----|-----|-----|-----|-----|-----|-----|-----|-----|-----|-----|-----|-----|-----|-----|-----|------|
| d31 | d30 | d29 | d28 | d27 | d26 | d25 | d24 | d23 | d22 | d21 | d20 | d19 | d18 | d17 | d16 | d15 | d14 | d13 | d12 | d11 | d10 | d9  | d8  | d7  | d6  | d5  | D4  | d3  | d2  | d1  | d0  |      |
| d63 | d62 | d61 | d60 | d59 | d58 | d57 | d56 | d55 | d54 | d53 | d52 | d51 | d50 | d49 | d48 | d47 | d46 | d45 | d44 | d43 | d42 | d41 | d40 | d39 | d38 | d37 | d36 | d35 | d34 | d33 | d32 | MODE |
| A7  | A6  | A5  | A4  | A3  | A2  | A1  | A0  | A11 | A10 | A9  | A8  | A7  | A6  | A5  | A4  | A3  | A2  | A1  | A0  | A11 | A10 | A9  | A8  | A7  | A6  | A5  | A4  | A3  | A2  | A1  | A0  | 1x12 |
| -   | -   | -   | -   | A11 | A10 | A9  | A8  | A7  | A6  | A5  | A4  | A3  | A2  | A1  | A0  | A11 | A10 | A9  | A8  | A7  | A6  | A5  | A4  | A3  | A2  | A1  | A0  | A11 | A10 | A9  | A8  |      |

**Table 5d – Packed pixel mapping into memory – 1x12 mode – 5 pixels/DW**

|     |     |     |    |    |     |     |    |    |     |     |    |    |     |     |    |    |     |     |    |    |     |     |    |    |     |     |    |    |     |     |    |    |      |
|-----|-----|-----|----|----|-----|-----|----|----|-----|-----|----|----|-----|-----|----|----|-----|-----|----|----|-----|-----|----|----|-----|-----|----|----|-----|-----|----|----|------|
|     | 31  | 30  | 29 | 28 | 27  | 26  | 25 | 24 | 23  | 22  | 21 | 20 | 19  | 18  | 17 | 16 | 15  | 14  | 13 | 12 | 11  | 10  | 9  | 8  | 7   | 6   | 5  | 4  | 3   | 2   | 1  | 0  |      |
|     | 63  | 62  | 61 | 60 | 59  | 58  | 57 | 56 | 55  | 54  | 53 | 52 | 51  | 50  | 49 | 48 | 47  | 46  | 45 | 44 | 43  | 42  | 41 | 40 | 39  | 38  | 37 | 36 | 35  | 34  | 33 | 32 | MODE |
| DW1 | A7  | A6  | A5 | A4 | A3  | A2  | A1 | A0 | B11 | B10 | B9 | B8 | B7  | B6  | B5 | B4 | B3  | B2  | B1 | B0 | A11 | A10 | A9 | A8 | A7  | A6  | A5 | A4 | A3  | A2  | A1 | A0 | 2x12 |
| DW1 | B3  | B2  | B1 | B0 | A11 | A10 | A9 | A8 | A7  | A6  | A5 | A4 | A3  | A2  | A1 | A0 | B11 | B10 | B9 | B8 | B7  | B6  | B5 | B4 | B3  | B2  | B1 | B0 | A11 | A10 | A9 | A8 |      |
| DW2 | B11 | B10 | B9 | B8 | B7  | B6  | B5 | B4 | B3  | B2  | B1 | B0 | A11 | A10 | A9 | A8 | A7  | A6  | A5 | A4 | A3  | A2  | A1 | A0 | B11 | B10 | B9 | B8 | B7  | B6  | B5 | B4 |      |
| DW2 | A7  | A6  | A5 | A4 | A3  | A2  | A1 | A0 | B11 | B10 | B9 | B8 | B7  | B6  | B5 | B4 | B3  | B2  | B1 | B0 | A11 | A10 | A9 | A8 | A7  | A6  | A5 | A4 | A3  | A2  | A1 | A0 |      |
| DW3 | B3  | B2  | B1 | B0 | A11 | A10 | A9 | A8 | A7  | A6  | A5 | A4 | A3  | A2  | A1 | A0 | B11 | B10 | B9 | B8 | B7  | B6  | B5 | B4 | B3  | B2  | B1 | B0 | A11 | A10 | A9 | A8 |      |
| DW3 | B11 | B10 | B9 | B8 | B7  | B6  | B5 | B4 | B3  | B2  | B1 | B0 | A11 | A10 | A9 | A8 | A7  | A6  | A5 | A4 | A3  | A2  | A1 | A0 | B11 | B10 | B9 | B8 | B7  | B6  | B5 | B4 |      |

**Table 5e – Packed pixel mapping into memory – 2x12 mode – 16 pixels/3 DWs**

|     |     |     |    |    |     |     |    |    |     |     |    |    |     |     |    |    |     |     |    |    |     |     |    |    |     |     |    |    |     |     |    |    |      |
|-----|-----|-----|----|----|-----|-----|----|----|-----|-----|----|----|-----|-----|----|----|-----|-----|----|----|-----|-----|----|----|-----|-----|----|----|-----|-----|----|----|------|
|     | 31  | 30  | 29 | 28 | 27  | 26  | 25 | 24 | 23  | 22  | 21 | 20 | 19  | 18  | 17 | 16 | 15  | 14  | 13 | 12 | 11  | 10  | 9  | 8  | 7   | 6   | 5  | 4  | 3   | 2   | 1  | 0  |      |
|     | 63  | 62  | 61 | 60 | 59  | 58  | 57 | 56 | 55  | 54  | 53 | 52 | 51  | 50  | 49 | 48 | 47  | 46  | 45 | 44 | 43  | 42  | 41 | 40 | 39  | 38  | 37 | 36 | 35  | 34  | 33 | 32 | MODE |
| DW1 | C7  | C6  | C5 | C4 | C3  | C2  | C1 | C0 | B11 | B10 | B9 | B8 | B7  | B6  | B5 | B4 | B3  | B2  | B1 | B0 | A11 | A10 | A9 | A8 | A7  | A6  | A5 | A4 | A3  | A2  | A1 | A0 | 3x12 |
| DW1 | C3  | C2  | C1 | C0 | B11 | B10 | B9 | B8 | B7  | B6  | B5 | B4 | B3  | B2  | B1 | B0 | A11 | A10 | A9 | A8 | A7  | A6  | A5 | A4 | A3  | A2  | A1 | A0 | C11 | C10 | C9 | C8 |      |
| DW2 | B11 | B10 | B9 | B8 | B7  | B6  | B5 | B4 | B3  | B2  | B1 | B0 | A11 | A10 | A9 | A8 | A7  | A6  | A5 | A4 | A3  | A2  | A1 | A0 | C11 | C10 | C9 | C8 | C7  | C6  | C5 | C4 |      |
| DW2 | B7  | B6  | B5 | B4 | B3  | B2  | B1 | B0 | A11 | A10 | A9 | A8 | A7  | A6  | A5 | A4 | A3  | A2  | A1 | A0 | C11 | C10 | C9 | C8 | C7  | C6  | C5 | C4 | C3  | C2  | C1 | C0 |      |
| DW3 | B3  | B2  | B1 | B0 | A11 | A10 | A9 | A8 | A7  | A6  | A5 | A4 | A3  | A2  | A1 | A0 | C11 | C10 | C9 | C8 | C7  | C6  | C5 | C4 | C3  | C2  | C1 | C0 | B11 | B10 | B9 | B8 |      |
| DW3 | -   | -   | -  | -  | -   | -   | -  | -  | -   | -   | -  | -  | -   | -   | -  | -  | C11 | C10 | C9 | C8 | C7  | C6  | C5 | C4 | C3  | C2  | C1 | C0 | B11 | B10 | B9 | B8 |      |

**Table 5f – Packed pixel mapping into memory – 3x12 mode – 15 pixels/3 DWs**

|     |     |     |    |    |     |     |    |    |     |     |    |    |     |     |    |    |     |     |    |    |     |     |    |    |     |     |    |    |     |     |    |    |      |
|-----|-----|-----|----|----|-----|-----|----|----|-----|-----|----|----|-----|-----|----|----|-----|-----|----|----|-----|-----|----|----|-----|-----|----|----|-----|-----|----|----|------|
|     | 31  | 30  | 29 | 28 | 27  | 26  | 25 | 24 | 23  | 22  | 21 | 20 | 19  | 18  | 17 | 16 | 15  | 14  | 13 | 12 | 11  | 10  | 9  | 8  | 7   | 6   | 5  | 4  | 3   | 2   | 1  | 0  |      |
|     | 63  | 62  | 61 | 60 | 59  | 58  | 57 | 56 | 55  | 54  | 53 | 52 | 51  | 50  | 49 | 48 | 47  | 46  | 45 | 44 | 43  | 42  | 41 | 40 | 39  | 38  | 37 | 36 | 35  | 34  | 33 | 32 | MODE |
| DW1 | C7  | C6  | C5 | C4 | C3  | C2  | C1 | C0 | B11 | B10 | B9 | B8 | B7  | B6  | B5 | B4 | B3  | B2  | B1 | B0 | A11 | A10 | A9 | A8 | A7  | A6  | A5 | A4 | A3  | A2  | A1 | A0 | 4x12 |
| DW1 | B3  | B2  | B1 | B0 | A11 | A10 | A9 | A8 | A7  | A6  | A5 | A4 | A3  | A2  | A1 | A0 | D11 | D10 | D9 | D8 | D7  | D6  | D5 | D4 | D3  | D2  | D1 | D0 | C11 | C10 | C9 | C8 |      |
| DW2 | D11 | D10 | D9 | D8 | D7  | D6  | D5 | D4 | D3  | D2  | D1 | D0 | C11 | C10 | C9 | C8 | C7  | C6  | C5 | C4 | C3  | C2  | C1 | C0 | B11 | B10 | B9 | B8 | B7  | B6  | B5 | B4 |      |
| DW2 | C7  | C6  | C5 | C4 | C3  | C2  | C1 | C0 | B11 | B10 | B9 | B8 | B7  | B6  | B5 | B4 | B3  | B2  | B1 | B0 | A11 | A10 | A9 | A8 | A7  | A6  | A5 | A4 | A3  | A2  | A1 | A0 |      |
| DW3 | B3  | B2  | B1 | B0 | A11 | A10 | A9 | A8 | A7  | A6  | A5 | A4 | A3  | A2  | A1 | A0 | D11 | D10 | D9 | D8 | D7  | D6  | D5 | D4 | D3  | D2  | D1 | D0 | C11 | C10 | C9 | C8 |      |
| DW3 | D11 | D10 | D9 | D8 | D7  | D6  | D5 | D4 | D3  | D2  | D1 | D0 | C11 | C10 | C9 | C8 | C7  | C6  | C5 | C4 | C3  | C2  | C1 | C0 | B11 | B10 | B9 | B8 | B7  | B6  | B5 | B4 |      |

**Table 5g – Packed pixel mapping into memory – 4x12 mode – 16 pixels/3 DWs**

|     |    |    |    |    |    |    |    |    |    |    |    |    |    |    |    |    |    |    |    |    |    |    |    |    |    |    |    |    |    |    |    |    |           |
|-----|----|----|----|----|----|----|----|----|----|----|----|----|----|----|----|----|----|----|----|----|----|----|----|----|----|----|----|----|----|----|----|----|-----------|
|     | 31 | 30 | 29 | 28 | 27 | 26 | 25 | 24 | 23 | 22 | 21 | 20 | 19 | 18 | 17 | 16 | 15 | 14 | 13 | 12 | 11 | 10 | 9  | 8  | 7  | 6  | 5  | 4  | 3  | 2  | 1  | 0  |           |
|     | 63 | 62 | 61 | 60 | 59 | 58 | 57 | 56 | 55 | 54 | 53 | 52 | 51 | 50 | 49 | 48 | 47 | 46 | 45 | 44 | 43 | 42 | 41 | 40 | 39 | 38 | 37 | 36 | 35 | 34 | 33 | 32 | MODE      |
| DW1 | B7 | B6 | B5 | B4 | B3 | B2 | B1 | B0 | R7 | R6 | R5 | R4 | R3 | R2 | R1 | R0 | G7 | G6 | G5 | G4 | G3 | G2 | G1 | G0 | B7 | B6 | B5 | B4 | B3 | B2 | B1 | B0 | RGB<br>24 |
| DW1 | G7 | G6 | G5 | G4 | G3 | G2 | G1 | G0 | B7 | B6 | B5 | B4 | B3 | B2 | B1 | B0 | R7 | R6 | R5 | R4 | R3 | R2 | R1 | R0 | G7 | G6 | G5 | G4 | G3 | G2 | G1 | G0 |           |
| DW2 | R7 | R6 | R5 | R4 | R3 | R2 | R1 | R0 | G7 | G6 | G5 | G4 | G3 | G2 | G1 | G0 | B7 | B6 | B5 | B4 | B3 | B2 | B1 | B0 | R7 | R6 | R5 | R4 | R3 | R2 | R1 | R0 |           |
| DW2 | B7 | B6 | B5 | B4 | B3 | B2 | B1 | B0 | R7 | R6 | R5 | R4 | R3 | R2 | R1 | R0 | G7 | G6 | G5 | G4 | G3 | G2 | G1 | G0 | B7 | B6 | B5 | B4 | B3 | B2 | B1 | B0 |           |
| DW3 | G7 | G6 | G5 | G4 | G3 | G2 | G1 | G0 | B7 | B6 | B5 | B4 | B3 | B2 | B1 | B0 | R7 | R6 | R5 | R4 | R3 | R2 | R1 | R0 | G7 | G6 | G5 | G4 | G3 | G2 | G1 | G0 |           |
| DW3 | R7 | R6 | R5 | R4 | R3 | R2 | R1 | R0 | G7 | G6 | G5 | G4 | G3 | G2 | G1 | G0 | B7 | B6 | B5 | B4 | B3 | B2 | B1 | B0 | R7 | R6 | R5 | R4 | R3 | R2 | R1 | R0 |           |

**Table 5h – Packed pixel mapping into memory – RGB24 mode – 8 pixels/3 DWs**

|     |     |     |     |     |     |     |     |     |     |     |     |     |     |     |     |     |     |     |     |     |     |     |     |     |     |     |     |     |     |     |     |      |
|-----|-----|-----|-----|-----|-----|-----|-----|-----|-----|-----|-----|-----|-----|-----|-----|-----|-----|-----|-----|-----|-----|-----|-----|-----|-----|-----|-----|-----|-----|-----|-----|------|
| d31 | d30 | d29 | d28 | d27 | d26 | d25 | d24 | d23 | d22 | d21 | d20 | d19 | d18 | d17 | d16 | d15 | d14 | d13 | d12 | d11 | d10 | d9  | d8  | d7  | d6  | d5  | d4  | d3  | d2  | d1  | d0  |      |
| d63 | d62 | d61 | d60 | d59 | d58 | d57 | d56 | d55 | d54 | d53 | d52 | d51 | d50 | d49 | d48 | d47 | d46 | d45 | d44 | d43 | d42 | d41 | d40 | d39 | d38 | d37 | d36 | d35 | d34 | d33 | d32 | MODE |
| -   | -   | R9  | R8  | R7  | R6  | R5  | R4  | R3  | R2  | R1  | R0  | G9  | G8  | G7  | G6  | G5  | G4  | G3  | G2  | G1  | G0  | B9  | B8  | B7  | B6  | B5  | B4  | B3  | B2  | B1  | B0  | RGB  |
| -   | -   | R9  | R8  | R7  | R6  | R5  | R4  | R3  | R2  | R1  | R0  | G9  | G8  | G7  | G6  | G5  | G4  | G3  | G2  | G1  | G0  | B9  | B8  | B7  | B6  | B5  | B4  | B3  | B2  | B1  | B0  | 30   |

**Table 5i – Packed pixel mapping into memory – RGB30 mode – 2 pixels/DW**

|     |     |     |    |    |     |     |    |    |     |     |    |    |     |     |    |    |     |     |    |    |     |     |    |    |     |     |    |    |     |     |    |    |           |
|-----|-----|-----|----|----|-----|-----|----|----|-----|-----|----|----|-----|-----|----|----|-----|-----|----|----|-----|-----|----|----|-----|-----|----|----|-----|-----|----|----|-----------|
|     | 31  | 30  | 29 | 28 | 27  | 26  | 25 | 24 | 23  | 22  | 21 | 20 | 19  | 18  | 17 | 16 | 15  | 14  | 13 | 12 | 11  | 10  | 9  | 8  | 7   | 6   | 5  | 4  | 3   | 2   | 1  | 0  |           |
|     | 63  | 62  | 61 | 60 | 59  | 58  | 57 | 56 | 55  | 54  | 53 | 52 | 51  | 50  | 49 | 48 | 47  | 46  | 45 | 44 | 43  | 42  | 41 | 40 | 39  | 38  | 37 | 36 | 35  | 34  | 33 | 32 | MODE      |
| DW1 | R7  | R6  | R5 | R4 | R3  | R2  | R1 | R0 | G11 | G10 | G9 | G8 | G7  | G6  | G5 | G4 | G3  | G2  | G1 | G0 | B11 | B10 | B9 | B8 | B7  | B6  | B5 | B4 | B3  | B2  | B1 | B0 | RGB<br>36 |
| DW1 | R3  | R2  | R1 | R0 | G11 | G10 | G9 | G8 | G7  | G6  | G5 | G4 | G3  | G2  | G1 | G0 | B11 | B10 | B9 | B8 | B7  | B6  | B5 | B4 | B3  | B2  | B1 | B0 | R11 | R10 | R9 | R8 |           |
| DW2 | G11 | G10 | G9 | G8 | G7  | G6  | G5 | G4 | G3  | G2  | G1 | G0 | B11 | B10 | B9 | B8 | B7  | B6  | B5 | B4 | B3  | B2  | B1 | B0 | R11 | R10 | R9 | R8 | R7  | R6  | R5 | R4 |           |
| DW2 | G7  | G6  | G5 | G4 | G3  | G2  | G1 | G0 | B11 | B10 | B9 | B8 | B7  | B6  | B5 | B4 | B3  | B2  | B1 | B0 | R11 | R10 | R9 | R8 | R7  | R6  | R5 | R4 | R3  | R2  | R1 | R0 |           |
| DW3 | G3  | G2  | G1 | G0 | B11 | B10 | B9 | B8 | B7  | B6  | B5 | B4 | B3  | B2  | B1 | B0 | R11 | R10 | R9 | R8 | R7  | R6  | R5 | R4 | R3  | R2  | R1 | R0 | G11 | G10 | G9 | G8 |           |
| DW3 | -   | -   | -  | -  | -   | -   | -  | -  | -   | -   | -  | -  | R11 | R10 | R9 | R8 | R7  | R6  | R5 | R4 | R3  | R2  | R1 | R0 | G11 | G10 | G9 | G8 | G7  | G6  | G5 | G4 |           |

**Table 5j – Packed pixel mapping into memory – RGB36 mode – 5 pixels/3 DWs**

|                         |   |
|-------------------------|---|
| <b>Pixel Buffering</b>  | The pixel data formatted by the video capture engine is stored into two on-board FIFO memories. This memory serves as an elastic store for formatted video pixel data. The FIFOs are managed by an independent pair of controllers, implemented in the FPGA, supporting concurrent operation. The two FIFOs are utilized in a ping-pong fashion such that while one is being filled with new pixel data, the other is being emptied via DMA into host memory.   |
| <b>DMA</b>              | The DMA engine is responsible for reading formatted pixel data from the on-board FIFO memories and transferring them into host memory via the PCI Express interface. An intelligent scatter-gather method is utilized, providing for an efficient use of the PCI Express bandwidth. The use of non-contiguous 4Kbyte buffers provides support for the Windows operating system's memory allocation model.   |
| <b>Serial Interface</b> | A bi-directional Universal Asynchronous Receiver Transmitter ( UART ) is provided for each Camera Link serial interface. It transmits and receives ASYNC formatted characters with 1 Start bit, 8 data bits, no parity and 1 Stop bit. The baud rate of this interface can be configured by the user to be any one of a set of standard bit rates ranging from 4800 to 115.2K bits per second. A software interface to the UART is provided by means of a Camera Link compliant ' <i>clser***.dll</i> ' file. |
| <b>Camera Control</b>   | The FrameLink Express card provides four discrete camera control bits per the Camera Link specification for each channel. These bits can be configured by the user via the FrameLink Express application GUI.   |
| <b>FPGA</b>             | The heart of the FrameLink Express is a dense Field Programmable Gate Array ( FPGA ). This FPGA implements all of the functions related to video data capture, formatting, storage and DMA. The firmware contents of the FPGA can be upgraded while in the field by following the instruction outlined in Section 3 of this document entitled 'Firmware Upgrade from Web Site'.   |

## What you need to get started

---

To begin using the FrameLink Express card, you need the following:

- A computer with a PCIe x1 ( or x4 ) slot or a laptop with an ExpressCard/54 ( or ExpressCard/34 ) slot.
- Microsoft Windows 7 or XP software.
- A computer with at least 256M bytes of RAM.
- A CD drive, and a hard disk on which to install the FrameLink Express software.

## Inspecting the FrameLink Express package

---

When you unpack your FrameLink Express package, you should visually inspect all of its contents. If something is missing or damaged, contact your Imperx representative.

### **Package contents**

You should have received the following items:

- The FrameLink Express card
- A CD with the FrameLink Express software suite
- A 'Quick Start' installation guide

# *Chapter* **2**

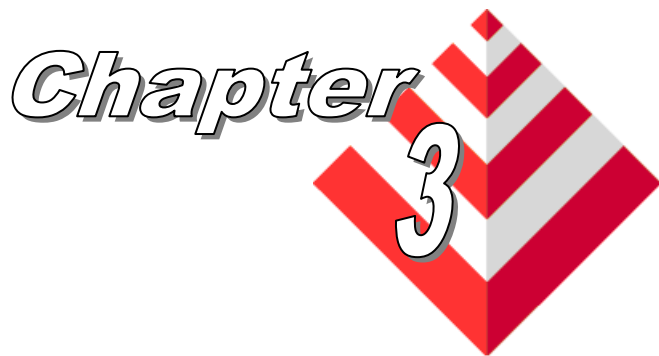


## **Hardware Installation**

Installing the FrameLink Express card is as simple as plugging it into an available PCIe x1 ( or x4 ) slot on your desktop computer's motherboard or a ExpressCard/54 ( or ExpressCard/34 ) slot on your laptop.



# Chapter 3



## Software Installation

This chapter explains how to install the FrameLink Express software.

### Software Suite

---

The FrameLink Express software suite consists of the following files:

Windows application files:

( located in *c:\Program Files\ImperX\FrameLink Express\* )

- |                       |  |
|-----------------------|--|
| FrameLink_Express.exe | - Area scan application program              |
| VceComEx.exe          | - Virtual COM port emulator                  |
| FrameLink_Express.chm | - Help file                                  |
| FrameLinkConsole.exe  | - Console program ( for debug purposes )     |
| FLExDrvManager.exe    | - Driver manager tool ( for debug purposes ) |
| Uninstall.exe         | - Un-install utility                         |
| VCECLB.dll            | - FrameLink Express library                  |
| clseripx.dll          | - CameraLink serial interface library        |
| ippLib.dll            | - Intel image processing library             |
| IpxLog.dll            | - ImperX logging library                     |
| IpxMisc.dll           | - ImperX miscellaneous library               |
| IpxMovieMaker.dll     | - ImperX movie maker library                 |
| DSMovieWriter.ax      | - Movie Writer DirectShow filter             |

Windows driver files:

( located in *c:\Program Files\ImperX\FrameLink Express\drivers\* )

- |                     |                                 |
|---------------------|---------------------------------|
| /Kernel/ folder     | - WinXP/2000/Vista driver files |
| /DirectShow/ folder | - DirectX driver files          |
| /Halcon/ folder     | - Halcon driver files           |
| /Labview/ folder    | - Labview driver files          |

Software Development Kit ( SDK ) files:

( located in *c:\Program Files\ImperX\FrameLink Express\SDK\* )

|                          |                      |
|--------------------------|----------------------|
| <i>/bin/</i> folder      | - binaries           |
| <i>/inc/</i> folder      | - include files      |
| <i>/lib/</i> folder      | - libraries          |
| <i>/doc/</i> folder      | - documentation      |
| <i>/examples/</i> folder | - sample source code |

Documentation files:

( located in *c:\Program Files\ImperX\FrameLink Express\Doc\* )

|   |                        |
|---|------------------------|
| <i>FrameLink_Express_Users_Manual.pdf</i> | - User manual document |
| <i>FrameLink_Express_Datasheet.pdf</i>    | - Technical datasheet  |

LUT Files:

( located in *c:\Program Files\ImperX\FrameLink Express\LUT\* )

|                     |                                    |
|---------------------|------------------------------------|
| <i>gamma_45.lut</i> | - Sample lookup table for Gamma_45 |
| <i>gamma_45.xls</i> | - Sample excel file for Gamma_45   |

CAM Files:

( located in *c:\Program Files\ImperX\FrameLink Express\CAM\_Files\* )

|                        |  |
|------------------------|--|
| <i>various folders</i> | - FrameLink Express configuration files for various camera vendors |
|------------------------|--|

Note that our FrameLink Express application program was created using our SDK ( software developers kit ). Our SDK is included in the standard FrameLink Express software suite that comes with the card.

## Software Installation from CD

---

Use the following steps to install the FrameLink Express software supplied on a CD. Note that 'click' refers to the left mouse button.

1. If a version of FrameLink Express was previously installed on this machine, then you must first remove it:

### **To remove the application files:**

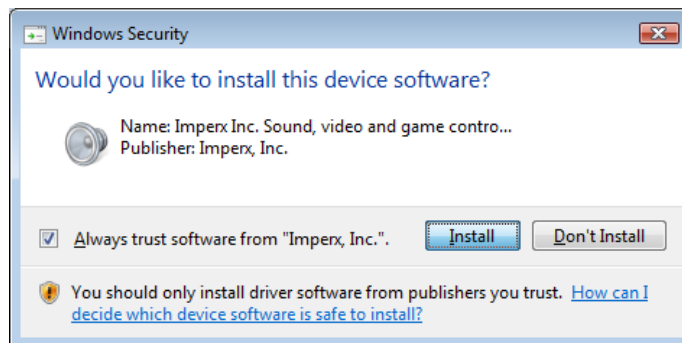
- 1.1 Click on "*Start*".
  - 1.2 Click on "*Settings*".
  - 1.3 Click on "*Control Panel*".
  - 1.4 Double click on "*Add or Remove Programs*".
  - 1.5 Click on "*FrameLink Express*".
  - 1.6 Click on "*Remove*".
  - 1.7 If the 'FrameLink Express – InstallShield Wizard' pops-up then do the following, otherwise go to step 1.8
    - Click on '*Remove*'.
    - Click '*Next*'.
    - Click '*Yes*'.
    - Click '*Finish*'.
  - 1.8 Click on "*Yes*".
  - 1.9 Click on "*Close*".
2. After having removed a previous version or if a version of FrameLink Express was NOT previously installed on this machine then:

### **The first step is to install the application files:**

- 2.1 Insert the FrameLink Express CD into the appropriate drive; the setup.exe file will run automatically. Note: If it does not start automatically, then click on "*Start*", "*Run*", enter or browse to "*(CD drive): setup.exe*" and click "*OK*".
- 2.2 Wait for the "FrameLink Express - InstallShield Wizard" screen to appear.
- 2.3 Follow the on-screen instructions.
- 2.4 For Windows XP 32 bit and Windows XP 64 bit, click "*Continue Anyway*" to continue.



- 2.5 For Windows Vista 32 bit and Windows Vista 64 bit, select “*Always trust software from Imperx, Inc.*” and click on “*Install*” button, when the following message appears:



- 2.6 When the following message appears, choose if you would like to register online by clicking on “*Register now*” or “*Skip*”.



- 2.7 Click “*Finish*”. This completes the software installation.
- 2.8 Reboot your computer.

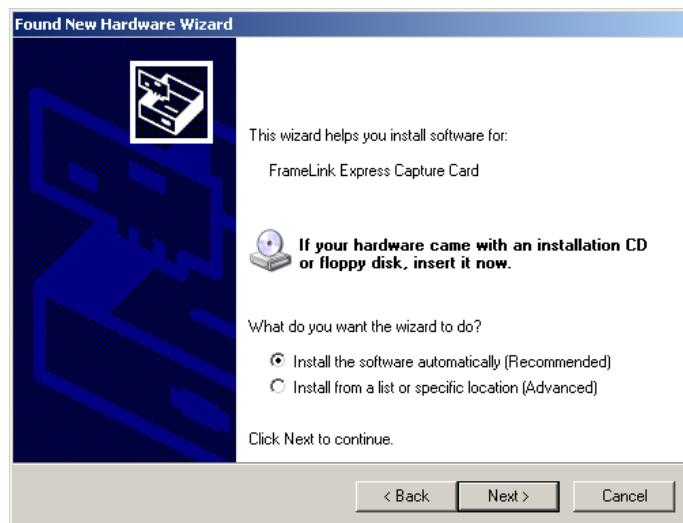
**The next step is to install the driver files:**

- 2.9 Insert the FrameLink Express card into the computer.
- 2.10 For Windows XP 32 bit and for Windows XP 64 bit:
  - Wait for the system to prompt you with a “Found New Hardware Wizard” dialog box.
  - Proceed to Step 2.11.
- For Windows Vista:
  - The driver will automatically be installed.
  - Proceed to step 2.16.
- 2.11 Under certain conditions, the following message may appear:



If this message appears, click “*No, not this time*”, then click “*Next*”.

- 2.12 When the following message appears, select “*Install the software automatically (Recommended)*”, then click “*Next*”.



2.13 The following message will appear:



2.14 Click "*Continue Anyway*" to continue.

2.15 When "Click finish to close the wizard" appears, click on "*Finish*".

2.16 This completes the driver installation.

## Software Upgrade from Web Site

---

New application and/or driver software may be released periodically to reflect improvements and/or functionality added to the FrameLink Express. You can retrieve these updates by visiting the download page of our web site at

[http://www.imperx.com/frame\\_grabbers/camera\\_link/FrameLink\\_Express\\_downloads.php](http://www.imperx.com/frame_grabbers/camera_link/FrameLink_Express_downloads.php)

Use the following steps to install newly released application software:

- 3.1 Uninstall all application files by following the instructions in step 1. of the 'Software Installation from CD' section.
- 3.2 Download the FrameLink\_Express\_Installer.exe file from the Imperx web site to a new folder on your PC ( we will use the folder C:\new\_FrameLink Express as an example ).
- 3.3 Left mouse click on "*Start*", "*Run*", enter or browse to *C:\new\_FrameLink Express\Framelink\_Express\_Installer.exe*.
- 3.4 Left mouse click on "*Open*", then "*OK*".
- 3.5 Follow the instructions starting from step 2.2 above.

## Firmware Upgrade from Web Site

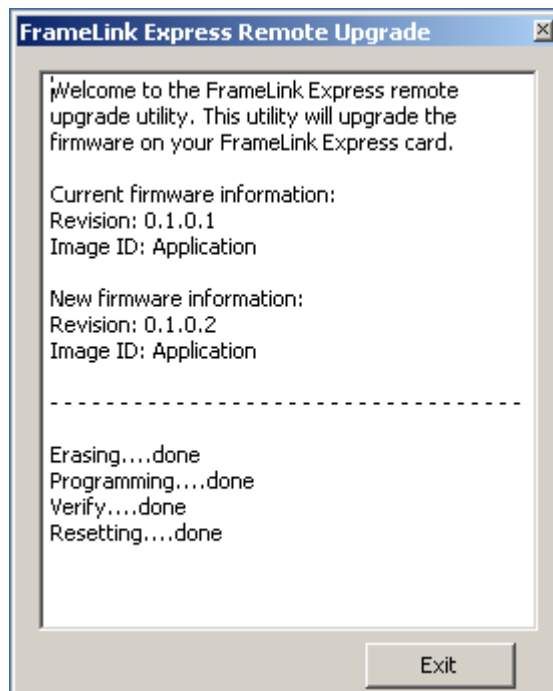
---

Your newly received FrameLink Express card has been programmed in the factory with the latest firmware prior to shipping. New firmware, however, may be released periodically to reflect improvements and/or added functionality. You can retrieve these updates by visiting the download page of our web site at:

[http://www.imperx.com/frame\\_grabbers/camera\\_link/FrameLink Express\\_downloads.php](http://www.imperx.com/frame_grabbers/camera_link/FrameLink Express_downloads.php)


Use the following steps to install newly released firmware:

1. Download and unzip the firmware Upgrade Utility file to a folder on your PC.
2. Insert the FrameLink Express card into the laptop. Note that if your system has two ExpressCard slots, then you must insert the card into the slot in which it was placed during the original driver installation.
3. If the system prompts you with a “New Hardware Found” dialog box, then you have not previously installed the driver. You must follow the steps outlined in the section above titled “Software Installation from CD” to install the driver.
4. To run the Upgrade Utility simply double click on the icon.  
**Note: DO NOT POWER DOWN OR REMOVE THE CARD WHILE PROGRAMMING IS IN PROGRESS!**
5. The Upgrade Utility will display the following dialog box:





# *Chapter* **4**



## **Using the FrameLink Express**

This chapter contains information on how to configure and use the FrameLink Express card.

## Running the FrameLink Express Application

---

The VCECLB\_app.exe program supplied with the FrameLink Express card is a stand-alone Windows based application. It provides an easy to use graphical user interface ( GUI ), allowing the user to configure the FrameLink Express card and to view, record and playback video data received from the CameraLink interface. The application consists of a main window as well as several other dialogs which can be accessed from the main menu or from convenient icons.

### Launching Application

To launch the FrameLink Express application, simply double left mouse click on the 'FrameLink Express' icon on the desktop.



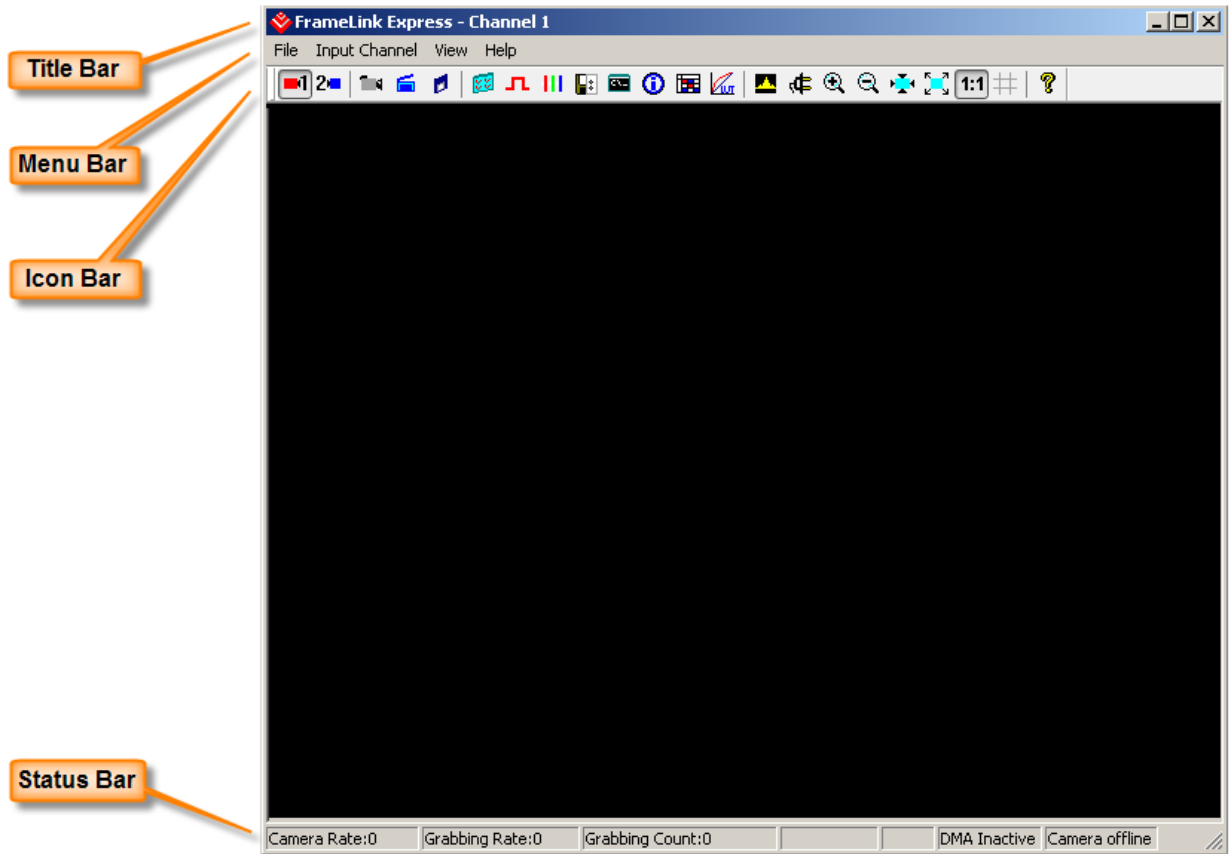
### Note

In the remainder of this chapter, references to 'clicking' on objects in the GUI refers to the left mouse button.

## Main Window

---

When the FrameLink Express application is executed, a main window titled 'FrameLink Express' will appear. The main window provides the primary area for viewing real-time images received from the camera. This window can be sized and moved to suit your needs. When image viewing is active, the size of this window will be automatically scaled as a function of the camera parameters ( i.e. pixels/line and lines/frame ) specified in the 'Camera Parameters' dialog.



The Main dialog contains a Title bar, a Menu bar, an Icon bar and a Status bar.

**Title Bar** The Title bar reflects the name assigned to the Camera Link port that is currently selected. A name of 'Channel 1' or 'Channel 2' is used as a default. The user can replace this default name by filling in the 'Alias' field in the 'Camera Parameters' dialog.

**Menu Bar** The Menu bar includes a set of pull-down sub-menus as follows:

**File** Clicking on this item reveals a pull-down menu with two options: 'Player' and 'Exit'.

**Play Files** This option opens the 'Player Dialog' and 'Player Control' windows.

**Exit** Clicking on this option causes the program to terminate.

**Input Channel** Reveals a pull-down menu allowing the user to select which Camera Link channel to connect to.

**View** Clicking on this item reveals a pull-down menu with the following options:

**Camera Parameters** Causes the 'Camera Parameters' dialog to appear.

**CC Control** Causes the 'CC Control' dialog to appear. ( 'PLC Control' dialog for the VCE-CLPCIE02 – see Appendix C ).

**RGB Control** Causes the 'RGB Control' dialog to appear. This option is only available if 'Bayer' or 'RGB' is selected in the 'video type' field of the 'Camera Parameters' dialog.

**Capture Settings** Causes the 'Capture Settings' dialog to appear.

**Terminal** Causes the 'Terminal' dialog to appear.

**Statistics** Causes the 'Statistics' dialog to appear.

**Hex Pixel Dump** Causes the 'Hex Pixel Dump' dialog to appear.

**PoCL** Causes the 'PoCL' dialog to appear.

**Lookup Table** Causes the 'Lookup Table' dialog to appear.

|                                |  |
|--------------------------------|--|
| <b>Histogram</b>               | Causes the 'Histogram' dialog to appear.   |
| <b>Stretch between markers</b> | Turns the Histogram bit stretching feature on/off.   |
| <b>Colorization</b>            | Turns the Histogram colorization feature on/off.   |
| <b>Zoom</b>                    | Causes the 'Zoom' menu to appear.  |
| <b>Grid</b>                    | Turns the grid on/off.   |
| <b>Toolbar</b>                 | Causes the toolbar to be displayed.  |
| <b>Status bar</b>              | Causes the status bar to be displayed.   |
| <b>Reset dialog position</b>   | Causes the screen position of all dialogs to return to their default locations. This is useful when a dialog disappears from the screen as a result of the user having adjusted the screen's resolution. |























**Help** Clicking on this item reveals a pull-down menu with two options: 'About' and 'Help Manual'.

**About** Causes version information to be displayed including release identifiers for the application software, library, driver and firmware. This information should be provided to Imperx technical support personnel during a service call.

**Help Manual** Causes an interactive point-and-click style help manual to be displayed. The help manual provides a summary description of all GUI controls and fields.

## Icon Bar

The Icon bar contains a set of icons that act as shortcuts into the features located on the Menu bar.

|   |  |
|---|--|
|    | Select <b>Channel #1</b>   |
|    | Select <b>Channel #2</b>   |
|    | Start/stop continuous <b>Grab</b>  |
|    | <b>Snap</b> single frame   |
|    | Start/stop <b>Capture</b> to disk  |
|    | Open <b>Camera Parameters</b> dialog   |
|    | Open <b>CC Control</b> dialog<br>( <b>PLC Control</b> dialog for the VCE-CLPC1e02 ). |
|    | Open <b>RGB Control</b> dialog   |
|    | Open <b>Capture Settings</b> dialog  |
|  | Open <b>Terminal</b> dialog  |
|  | Open <b>Statistics</b> dialog  |
|  | Open <b>Hex Pixel Dump</b> dialog  |
|  | Enable/disable <b>Lookup Table</b> processing  |
|  | Open <b>Histogram</b> dialog   |
|  | Open <b>PoCL</b> dialog  |
|  | <b>Zoom In</b>   |
|  | <b>Zoom Out</b>  |
|  | <b>Fit to Window</b>   |
|  | <b>Full Screen</b>   |
|  | <b>Zoom 1:1</b>  |
|  | Turn <b>Grid</b> on/off  |
|  | <b>Help</b>  |

## Status Bar

The Status bar reflects the real-time state of the current camera connection.

### Camera Rate

Displays the real-time frame rate of the attached camera as measured at the input of the FrameLink Express card.

### Grabbing Rate

Displays the real-time rate at which frames are being transferred from the card into host memory.

### Grabbing Count

Displays a running count of the total number of frames transferred into system memory. This counter is reset when 'grabbing' is stopped.

### DMA Status

Displays the real-time status of the DMA process as being either '**active**' or '**inactive**'.

'**Active**' indicates that the user has commanded the FrameLink Express to acquire video data by clicking on the 'Start Grab' button and that the camera is providing valid framing.

'**Inactive**' indicates that either the user has commanded the FrameLink Express to stop acquiring video data by clicking on the 'Stop Grab' button or that grabbing is enabled but the camera is not providing valid framing.

### Camera Status

Displays the real-time status of the attached camera as being either '**online**' or '**offline**'.

'**Online**' indicates that the camera is powered on, attached and providing a video clock via the CameraLink interface.

'**Offline**' indicates that the FrameLink Express card is not receiving a video clock from the camera either because the camera is powered off or the CameraLink cable is disconnected.

## Camera Parameters Dialog

The Camera Parameters dialog allows the user to configure the FrameLink Express card with the operating parameters of the attached camera. For the FrameLink Express card to be able to properly acquire and display images from an attached camera, the settings entered into this screen must match the parameters of the camera.

**Manufacturer**  
**Model**  
**Description**

These text fields allow the user to record the vendor and part number of the attached camera. This text, along with all of the other settings, can then be saved as a .CXF file on the PC for later retrieval.

**Alias**

This is a user defined name for the channel. The text entered into this field will be displayed as the channel name in the Title bar.

**Load...**

Loads a previously saved camera configuration file. Clicking on this box will cause a Windows 'browse' box to appear. The user can then browse to the folder and file he wishes to open. The program will then open the selected file, parse it and populate the fields in the dialog.

**Save...**

Saves the current GUI fields as a camera configuration file. Clicking on this box will cause a Windows 'browse' box to appear. The user can then browse to a folder and enter a file name. The program will then create a .CXF file using the values in the dialog's fields and write it to the disk.



**Camera Resolution**

These fields specify the geometry of the attached camera and instructs the FrameLink Express on how to reconstruct a received image.

**Width (pixels):** These fields specify the total number of pixels per line. The Camera Link standard defines a line as being a series of pixels enveloped by the LVAL strobe and qualified by the DVAL strobe. Cameras generally provide some leading and trailing dummy pixels before and after a set of valid pixels. Most cameras can disqualify these dummy pixels by negating the DVAL signal. For cameras that do not disqualify the dummy pixels, the FrameLink Express has to be told the number of pre-valid, valid and post-valid pixels in order to properly construct an image.

**Pre-valid** Specifies the number of leading pixels prior to any valid pixels. The FrameLink Express will exclude these pixels from the displayed/captured image.

**Valid** Specifies the number of valid pixels. The FrameLink Express will include these pixels in the displayed/captured image.

**Post-valid** Specifies the number of trailing pixels following any valid pixels. The FrameLink Express will exclude these pixels from the displayed/captured image.

**Height (lines):** These fields specify the total number of lines per frame. The Camera Link standard defines a frame as being a series of lines enveloped by the FVAL strobe. Cameras can sometimes provide some leading and trailing dummy lines before and after a set of valid lines. Most cameras can disqualify these dummy lines by negating the FVAL signal. For cameras that do not disqualify the dummy lines, the FrameLink Express has to be told the number of pre-valid, valid and post-valid lines in order to properly construct an image.

**Pre-valid** Specifies the number of leading lines prior to any valid lines. The FrameLink Express will exclude these lines from the displayed/captured image.

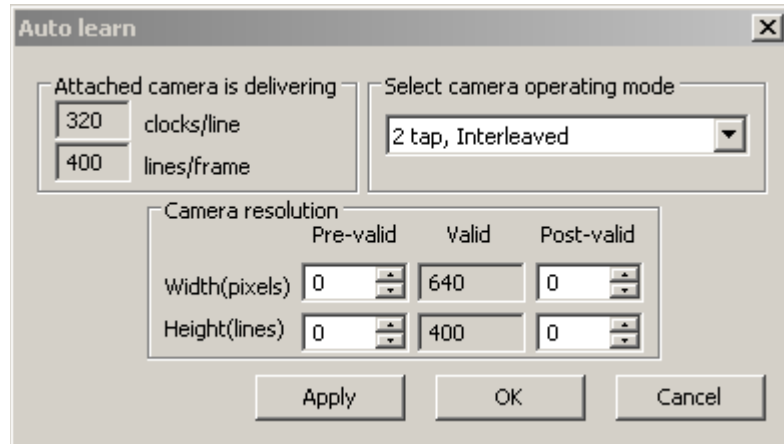
**Valid** Specifies the number of valid lines. The FrameLink Express will include these lines in the displayed/captured image.

**Post-valid** Specifies the number of trailing lines following

any valid lines. The FrameLink Express will exclude these lines from the displayed/captured image.

## Learn

Clicking on this button pops-up the 'Auto learn' dialog.

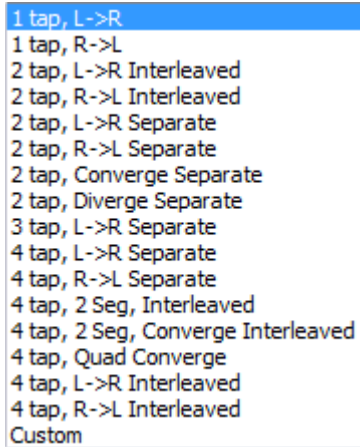


'Auto learn' is a unique feature of the FrameLink Express card which assists the user in entering the camera resolution parameters. The FrameLink Express card is continuously measuring the signals it receives from the CameraLink interface and therefore can determine what the camera's resolution is. It measures both the number of CLOCK transitions per LVAL ( clocks/line ) as well as the number of LVAL transitions per FVAL ( lines/frame ). It displays these results in the 'Attached camera is delivering' fields. The card, however, has no way of knowing how many taps are active and what the camera bit depth is. The user should select the operating mode of the camera and then click the 'Apply' button. This will cause the fields in the Camera Resolution group to automatically be populated.

NOTE: If the 'clocks/line' field is reporting a value of '0', then the camera may not be providing a DVAL signal on the Camera Link interface. If this is the case then cancel the Auto Learn dialog, select 'Ignore DVAL' under Strobes in the Camera Parameters dialog and then click on 'Learn' again to re-enter the Auto Learn dialog.

**Tap Reconstruction**

Specifies the number of taps and the pixel ordering provided by the attached camera. The following formats are supported:



**Swap taps**

Instructs the card to interchange the pixel data received from Tap1 and Tap2 of the Camera Link interface. This only applies to Base modes.

**More >>>**

Clicking on this button will cause an animation of the selected tap reconstruction mode to appear.

**Strobes**

Specifies how to treat the Camera Link strobes, where ‘DVAL’ is data valid, ‘LVAL’ is line valid and ‘FVAL’ is frame valid.

**Ignore DVAL**

Instructs the FrameLink Express card to ignore the ‘DVAL’ signal received from the CameraLink interface. Pixel capture will be qualified with the ‘FVAL’ and ‘LVAL’ signals only.

**Invert DVAL**

Instructs the FrameLink Express card to invert the ‘DVAL’ signal received from the CameraLink interface prior to processing it.

**Invert LVAL**

Instructs the FrameLink Express card to invert the ‘LVAL’ signal received from the CameraLink interface prior to processing it.

**Invert FVAL**

Instructs the FrameLink Express card to invert the ‘FVAL’ signal received from the CameraLink interface prior to processing it.

**Video Type**

Specifies the video mode as either or monochrome, Bayer or RGB.

**Camera Bit Depth**

Specifies the number of bits per pixel.

**Packed**

Instructs the card to pack pixels before transferring them to host memory. Packing uses the PCI Express bandwidth more efficiently and conserves memory space. Refer to Tables 5a – 5j.

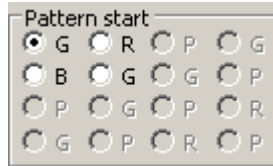
**Pattern Start**

Specifies the starting pixel in the Bayer or TrueSense pattern as provided by the camera. This selection is typically required when a camera is operated with an 'area of interest' feature enabled.

**Bayer Patterns**

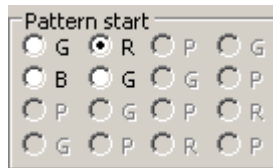
For the following examples, assume that 'n = number of pixels/line' and 'm = number of lines' then:

**Pattern #1** Use this selection when the camera provides the following pattern:



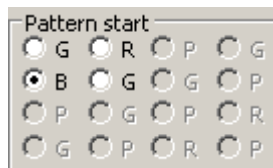
|      |     | Pixel |   |   |   |     |     |   |
|------|-----|-------|---|---|---|-----|-----|---|
|      |     | 1     | 2 | 3 | 4 | ... | n-1 | n |
| Line | 1   | G     | R | G | R |     | G   | R |
|      | 2   | B     | G | B | G |     | B   | G |
|      | 3   | G     | R | G | R |     | G   | R |
|      | 4   | B     | G | B | G |     | B   | G |
|      | :   |       |   |   |   |     |     |   |
|      | m-1 | G     | R | G | R |     | G   | R |
|      | m   | B     | G | B | G |     | B   | G |

**Pattern #2** Use this selection when the camera provides the following pattern:



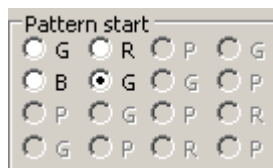
|      |     | Pixel |   |   |   |     |     |   |
|------|-----|-------|---|---|---|-----|-----|---|
|      |     | 1     | 2 | 3 | 4 | ... | n-1 | n |
| Line | 1   | R     | G | R | G |     | R   | G |
|      | 2   | G     | B | G | B |     | G   | B |
|      | 3   | R     | G | R | G |     | R   | G |
|      | 4   | G     | B | G | B |     | G   | B |
|      | :   |       |   |   |   |     |     |   |
|      | m-1 | R     | G | R | G |     | R   | G |
|      | m   | G     | B | G | B |     | G   | B |

**Pattern #3** Use this selection when the camera provides the following pattern:



|      |     | Pixel |   |   |   |     |     |   |
|------|-----|-------|---|---|---|-----|-----|---|
|      |     | 1     | 2 | 3 | 4 | ... | n-1 | n |
| Line | 1   | B     | G | B | G |     | B   | G |
|      | 2   | G     | R | G | R |     | G   | R |
|      | 3   | B     | G | B | G |     | B   | G |
|      | 4   | G     | R | G | R |     | G   | R |
|      | :   |       |   |   |   |     |     |   |
|      | m-1 | B     | G | B | G |     | B   | G |
|      | m   | G     | R | G | R |     | G   | R |

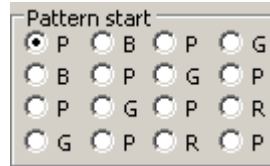
**Pattern #4** Use this selection when the camera provides the following pattern:



|      |     | Pixel |   |   |   |     |     |   |
|------|-----|-------|---|---|---|-----|-----|---|
|      |     | 1     | 2 | 3 | 4 | ... | n-1 | n |
| Line | 1   | G     | B | G | B |     | G   | B |
|      | 2   | R     | G | R | G |     | R   | G |
|      | 3   | G     | B | G | B |     | G   | B |
|      | 4   | R     | G | R | G |     | R   | G |
|      | :   |       |   |   |   |     |     |   |
|      | m-1 | G     | B | G | B |     | G   | B |
|      | m   | R     | G | R | G |     | R   | G |

## TrueSense Patterns

This is similar to the Bayer pattern except that the matrix is 4x4 instead of 2x2. Note that in a TrueSense pattern, in addition to the Green ( G ), Red ( R ) and Blue ( B ) pixels there are also Panchromatic ( P ) pixels.



## Apply

Causes the application to apply the current settings to the FrameLink Express card.

## Start/Stop Grab

This button will toggle between 'Start Grab' and 'Stop Grab' every time the user clicks on it. Clicking on 'Start Grab' enables the FrameLink Express's DMA engine and causes the main window to display live images received from the camera. Clicking on 'Stop Grab' disables the DMA engine and causes the display to freeze.

## Close

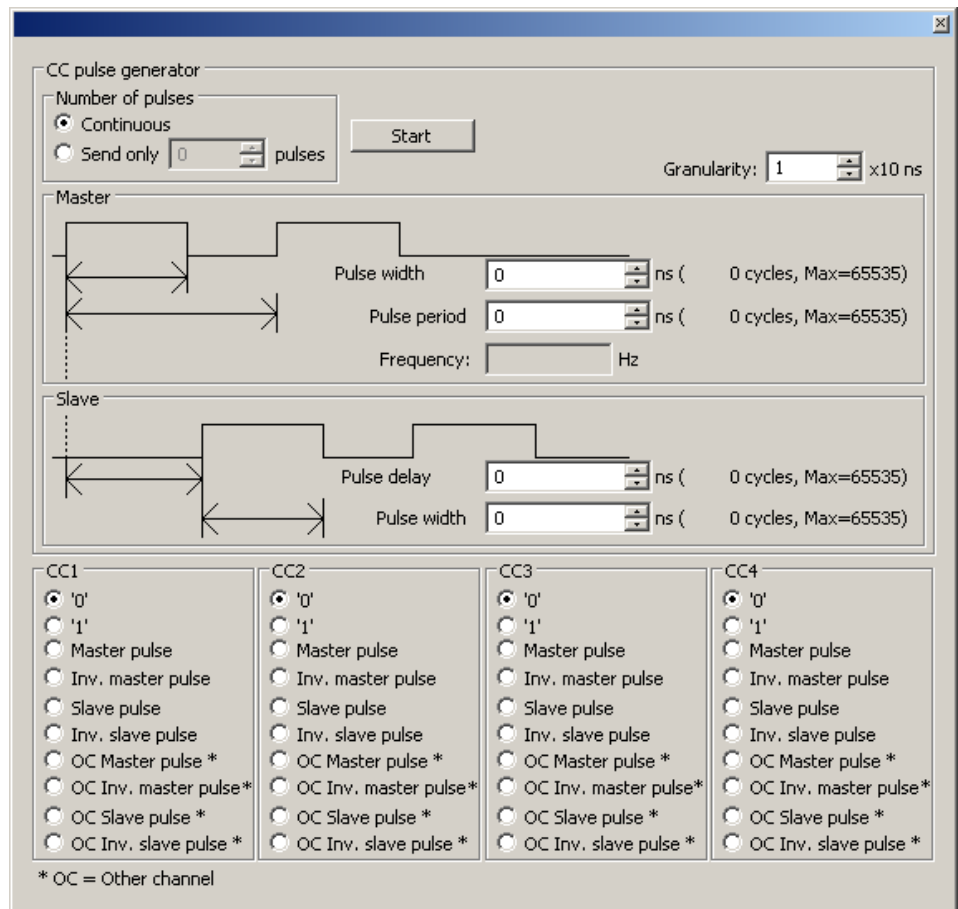
This button will close the Camera Parameters dialog.

## CC Control Dialog

The CC Control dialog allows the user to program the FrameLink Express card to generate signals on the Camera Link CC1-CC4 signals. These signals are often used by cameras to control triggering and exposure time via the host computer.

The CC Control dialog is not available on the VCE-CLPCIE02 card. The VCE-CLPCIE02 card uses a Programmable Logic Controller instead ( see Appendix C ).

The FrameLink Express includes two pulse generators per channel: Master and Slave. Both pulse generator's outputs can be routed to the CC1-CC4 signals of either channel.



### Start

This button toggles between 'Start' and 'Stop'. Causes both Master and Slave pulse generators to start or stop running.

### Number of pulses:

Determines how often to send CC pulses:

|                          |  |
|--------------------------|--|
| <b>Continuous</b>        | Configures the FrameLink Express to send a continuous stream of CC pulses. Clicking on the ‘Start’ button causes the pulses to begin. Clicking on the ‘Stop’ button causes the pulses to cease.  |
| <b>Send only</b>         | Configures the FrameLink Express to send a programmed number of pulses. Clicking on the ‘Start’ button causes the sequence to begin. The sequence will end after the programmed number of pulses are delivered.  |
| <b>Granularity</b>       | Sets the granularity of the clock used by the Master and Slave pulse generators. A value of ‘1’ corresponds to a clock period of 10 nSeconds, a value of ‘2’ to 20 nSeconds etc. All master and slave pulse variables ( i.e. width, period, etc. ) are scaled by this clock granularity. |
| <b>Master</b>            | Sets the parameters for the Master pulse generator:  |
| <b>Pulse width</b>       | Sets the width of the master pulse.  |
| <b>Pulse period</b>      | Sets the period ( repetition rate ) of the master pulse.   |
| <b>Slave</b>             | Sets the parameters for the Slave pulse generator:   |
| <b>Pulse delay</b>       | Sets the delay between the master and slave pulses.  |
| <b>Pulse width</b>       | Sets the width of the slave pulse.   |
| <b>CC1 – CC4</b>         | Configures the behavior of each of the four CC signals:  |
| <b>‘0’</b>               | Drive the selected CC signal to a logic ‘0’.   |
| <b>‘1’</b>               | Drive the selected CC signal to a logic ‘1’.   |
| <b>Master pulse</b>      | Drive the selected CC signal with the output of the master pulse generator.  |
| <b>Inv. master Pulse</b> | Drive the selected CC signal with the inverted output of the master pulse generator.   |
| <b>Slave pulse</b>       | Drive the selected CC signal with the output of the slave pulse generator.   |
| <b>Inv. slave Pulse</b>  | Drive the selected CC signal with the inverted output of the slave pulse generator.  |
| <b>OC Master pulse</b>   | Drive the selected CC signal with the output of the other channel’s master pulse generator.  |

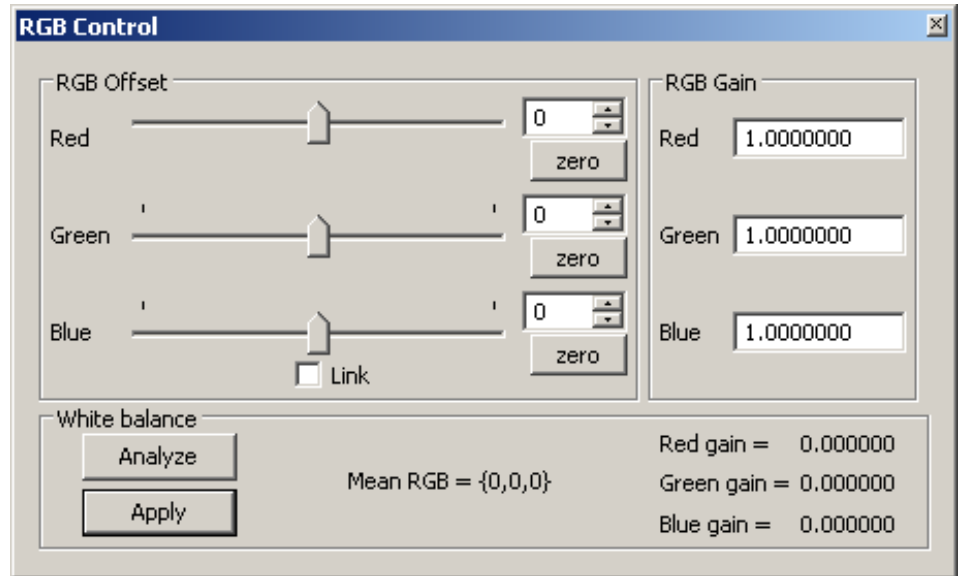
|                             |  |
|-----------------------------|--|
| <b>OC Inv. master Pulse</b> | Drive the selected CC signal with the inverted output of the other channel's master pulse generator. |
| <b>OC Slave pulse</b>       | Drive the selected CC signal with the output of the other channel's slave pulse generator.           |
| <b>OC Inv. slave Pulse</b>  | Drive the selected CC signal with the inverted output of the other channel's slave pulse generator.  |



## RGB Control Dialog

---

The RGB Control dialog allows the user to adjust the gain and offset for each of the RGB color components. This option is only available if 'Bayer' or 'RGB' is selected in the 'video type' field of the 'Camera Parameters' dialog.



### RGB Offset

Specifies the amount of offset to apply to each of the R, G and B components.

### RGB Gain

Specifies the amount of gain to apply to each of the R, G and B components.

### White balance

Performs an automatic white balancing procedure.

#### Analyze

Instructs the FrameLink Express card to analyze the current image received from the camera and to calculate a set of RGB Gain coefficients that will cause the sample image to be white balanced.

NOTE: Before clicking on 'Analyze', the user should point the camera at a uniform white target.

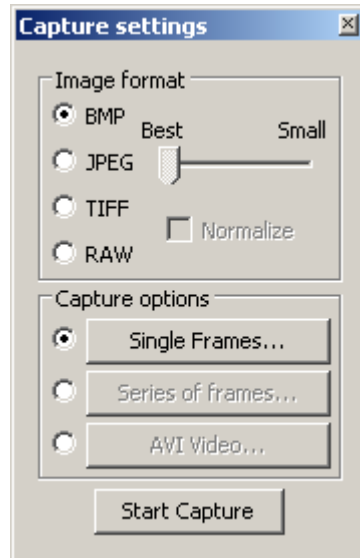
#### Apply

Instructs the FrameLink Express card to use the calculated RGB Gain coefficients acquired during the 'analyze' procedure and to apply these to the received image prior to display.

## Capture Settings Dialog

---

This dialog gives the user complete control over image storage.



### Start/Stop Capture

This button will toggle between **'Start Capture'** and **'Stop Capture'** every time the user clicks on it. Clicking on **'Start Capture'** starts the process of recording the images to disk. The options set in the **'Capture Options'** field determine what, how and when actual recording is performed. Clicking on **'Stop Capture'** causes recording to stop.

### Close

This button will hide the Capture Settings Dialog screen. You can invoke it again by either hitting Ctrl-S or by selecting it from the Control Panel pull-down menu.

### Image Format

When recording images to disk, this option selects the format, **'BMP'**, **'JPEG'**, **'TIFF'** or **'RAW'**, that the image will be saved in. Selecting **'JPEG'** activates a compression slider. **'Best'** provides the least compression, while **'Small'** provides the most compression.

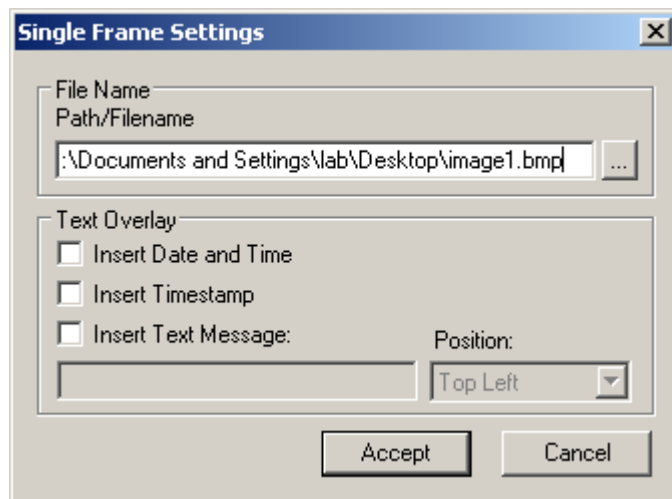
### Normalize

Normalize defines the way in which TIFF files are created. Since a TIFF file uses 16 bits to represent each pixel and cameras can produce less than 16 bit pixels, the normalize option is provided. If **'normalize'** is disabled, then left pixel padding is used so that 16 bit TIFF data is produced by appending zeros to the MSB bits of the pixel data. For example, for a 12 bit pixel the resultant 16 bit TIFF data is "0,0,0,0,p12, p11....p2,p1" where p12..p1 represent the 12 bit pixel. Left padding is useful when the user wishes to post-process the TIFF data. If **'normalize'** is enabled, then right pixel padding is used so that 16 bit TIFF data is

produced by shifting the pixel data left and appending zeros to the LSB bits of the pixel data. For example, for a 12 bit pixel the resultant 16 bit TIFF data is “p12, p11...p2,p1,0,0,0”. Right padding is useful when the user wishes to view the TIFF data using a standard TIFF viewer program.

**Capture Options** Determines how, when and where images are recorded to disk. Three choices are provided: ‘Single Frames’, ‘Series of Frames’ and ‘AVI Video’. Selecting the radio button and then clicking on each option box opens a new dialog providing additional options.

**Single Frames** Select this option when you wish to record one frame only. Clicking on this button causes the ‘Single Frame Settings’ dialog to open.



**Path/Filename** This text field allows you to provide a path and filename for the recorded image file. Clicking on the ‘...’ box will cause a Windows ‘browse’ box to appear. The user can then browse to a folder and enter a file name. The filename extension, .BMP or .JPG, will automatically be added depending on the image format chosen and therefore you do not need to include the filename extension.

**Text Overlay** Enabling ‘**Insert Date and Time**’ automatically overlays the date and time, received from the PC’s operating system, on each image recorded. Date and time formats are the same as those used on your computer. Enabling ‘**Insert Timestamp**’ automatically overlays an accurate timestamp on each image recorded. The timestamp is a decimal integer value indicating the time, in microseconds, when the card acquired the frame from the attached

camera. Enabling **'Insert Text Message'** allows you to enter a text string to be automatically overlaid on each image recorded. Clicking on **'Position'** causes a pull-down menu to appear which defines the placement position of the date/time/text message within the image. Available options include: Top-Left, Top-Center, Top-Right, Bottom-Left, Bottom-Center and Bottom-Right.

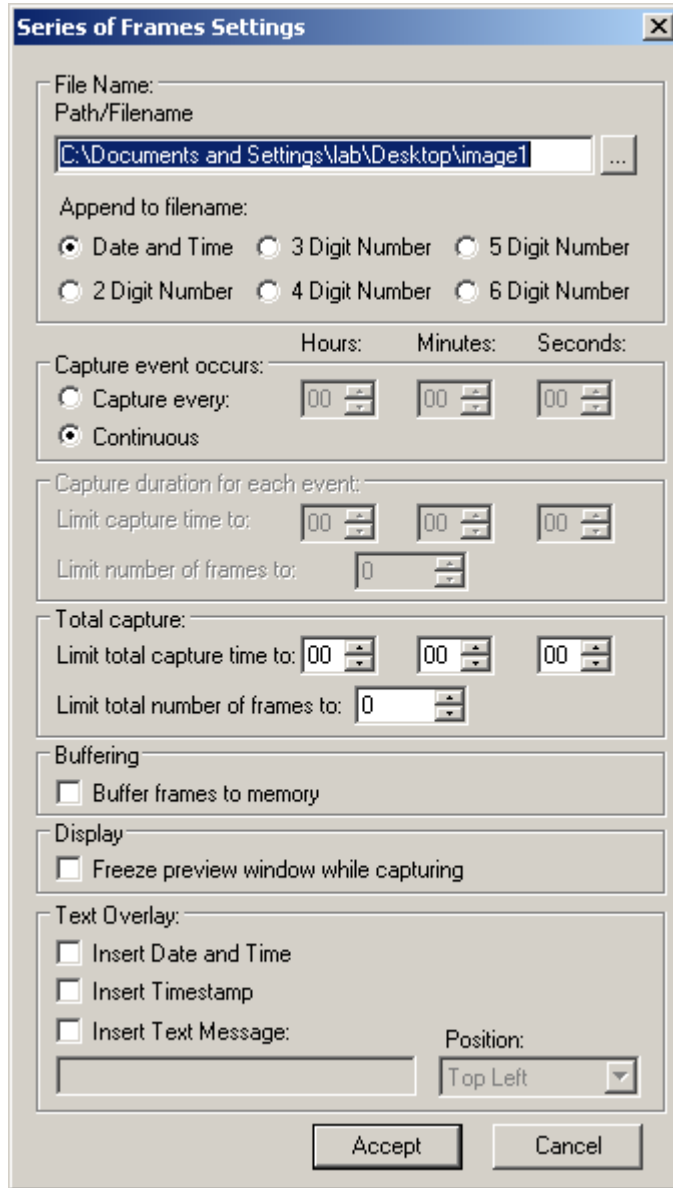
**Accept**

Clicking on this causes the entries made to the various fields to be accepted and then closes the 'Single Frame Settings' dialog window.

**Cancel**

Clicking on this causes the entries made to the various fields to be rejected and then closes the 'Single Frame Settings' dialog window.

**Series of Frames** Select this option when you wish to record multiple frames. Clicking on this button causes the ‘Series of Frames Settings’ dialog to open.



**Path/Filename** This text field allows you to provide a path to a folder where the recorded image files will be saved to. Clicking on the ‘...’ box will cause a Windows ‘browse’ box to appear. The user can then browse to a folder. The filename will automatically be created based on the choice made in the ‘Append to filename’ option. The filename extension, .BMP or .JPG, will automatically be added depending on the image format chosen.

**Append to filename** Allows the user to choose the format of the text filename to be created. Every time a recording file is created, the filename suffix will automatically be updated ( for the 'Date and Time' option ) or incremented ( for the 'N Digit Number' option ).

**Date and Time** This option will create files named as YYYYMMDDhhmmssnnn where:

Y - year (4 digits)  
M - month (2 digits)  
D - day (2 digits)  
h - hour (2 digits)  
m - minute (2 digits)  
s - second (2 digits)  
n - millisecond (3 digits)

**'N' Digit Number** This option will create numerically named files. The filename starts at 0 and is incremented by one after each frame is captured. If the number of frames captured exceeds the number of digits selected then the filename will continue to increment.

For example:

If '2 Digit Number' is selected then the files will be named as:

'00.bmp', '01.bmp' ... '99.bmp',  
'100.bmp', '101.bmp', etc.

If '4 Digit Number' is selected then the files will be named as:

'0000.bmp', '0001.bmp' ... '9999.bmp',  
'10000.bmp', '10001.bmp', etc.

**Capture event occurs:** Allows you to control how often to start capturing images.

**Capture every** Specifies how often, in time, to start capturing images. Use this feature to take snapshots at regular intervals in order to create a time-lapse series of images. This option is mutually exclusive with the 'Continuous' option.

**Continuous** Specifies that image capture is free-running.

**Capture duration for each event:** Allows you to control how much to capture with each capture event specified above. Limits can be specified by either time or number of frames, whichever occurs first.

**Limit capture time to** Allows you to limit the duration of the recording by the amount of time specified.

**Limit number of frames to** Allows you to limit the duration of the recording by the number of frames specified.

**Total capture:** Allows you to control how much to capture over all events specified above. Limits can be specified by either time or number of frames, whichever occurs first.

**Limit total capture time to** Allows you to limit the duration of the total recording by the amount of time specified.

**Limit total number of frames to** Allows you to limit the duration of the total recording by the number of frames specified

## Examples of how to use Capture timers and counters:

**Example #1:** To capture 5 frames, every 1.5 hours, over a 12 hour period.

Capture event occurs:

Capture every: 01 Hr 30 Min 00 Sec

Capture duration for each event:

Limit number of frames to: 5

Total capture:

Limit total capture time to: 12 Hr 00 Min 00 Sec

**Example #2:** To capture 5 minutes worth of images, every 15 minutes and not to exceed a total of 250 images.

Capture event occurs:

Capture every: 00 Hr 15 Min 00 Sec

Capture duration for each event:

Limit capture time to: 00 Hr 05 Min 00 Sec

Total capture:

Limit total number of frames to: 250

**Example #3:** To capture 10 frames, every 1 hour, over a 6 hour period and not to exceed a total of 300 images.

Capture event occurs:

Capture every: 01 Hr 00 Min 00 Sec

Capture duration for each event:

Limit number of frames to: 10

Total capture:

Limit total capture time to: 06 Hr 00 Min 00 Sec

Limit total number of frames to: 300

**Example #4:** To capture continuously for a period of 2 hours and not to exceed a total of 100 images.

Capture event occurs:

Continuous

Total capture:

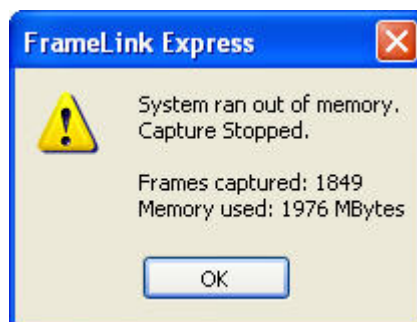
Limit total capture time to: 02 Hr 00 Min 00 Sec

Limit total number of frames to: 100



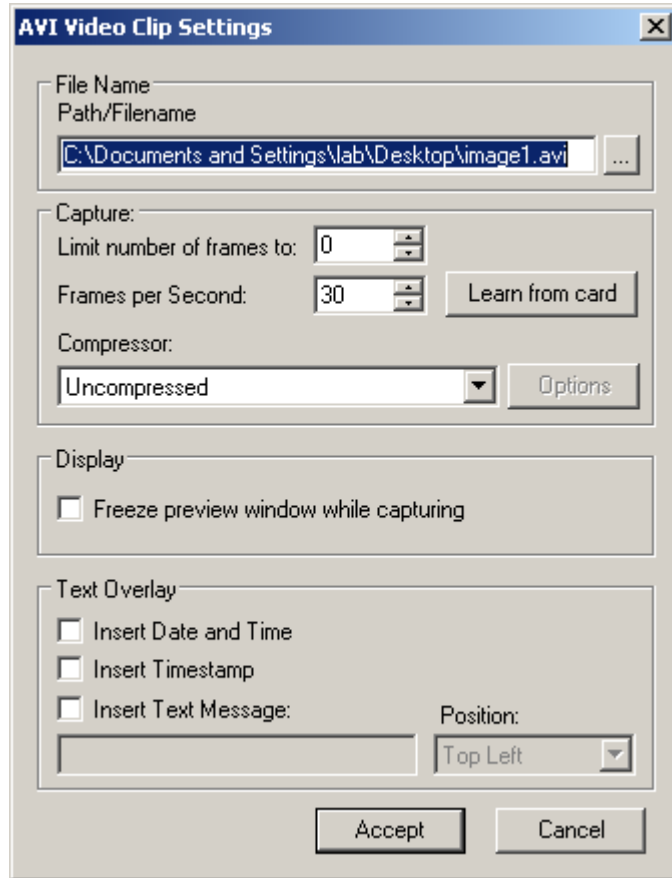
|  |   |
|--|---|
| <b>Buffer frames to memory</b>               | When selected will store images in system memory during capturing. When capturing is complete, the images in memory will be flushed to the disk drive. Select this option to improve capture performance ( i.e. the number of frames per second stored to disk ). If this option is not selected, images will be stored directly to disk and therefore capture performance will be limited by the disk's transfer rate. |
| <b>Freeze preview window while capturing</b> | When selected will stop the live image in the main window from updating during capture, otherwise the image will remain live. Selecting this option improves capture performance ( i.e. the number of frames per second stored to disk ).   |
| <b>Text Overlay</b>                          | Same as in 'Single Frames'.   |
| <b>Accept</b>                                | Same as in 'Single Frames'.   |
| <b>Cancel</b>                                | Same as in 'Single Frames'.   |

**NOTE:** While capturing is in progress, if the host operating system denies the FrameLink Express application's request to allocate more frame buffers in host memory then the following error message will appear.



## AVI Video

Select this option when you wish to create an AVI movie file. An AVI movie is a series of images assembled into a single AVI file. Clicking on this button causes the 'AVI Video Clip Settings' dialog to open.



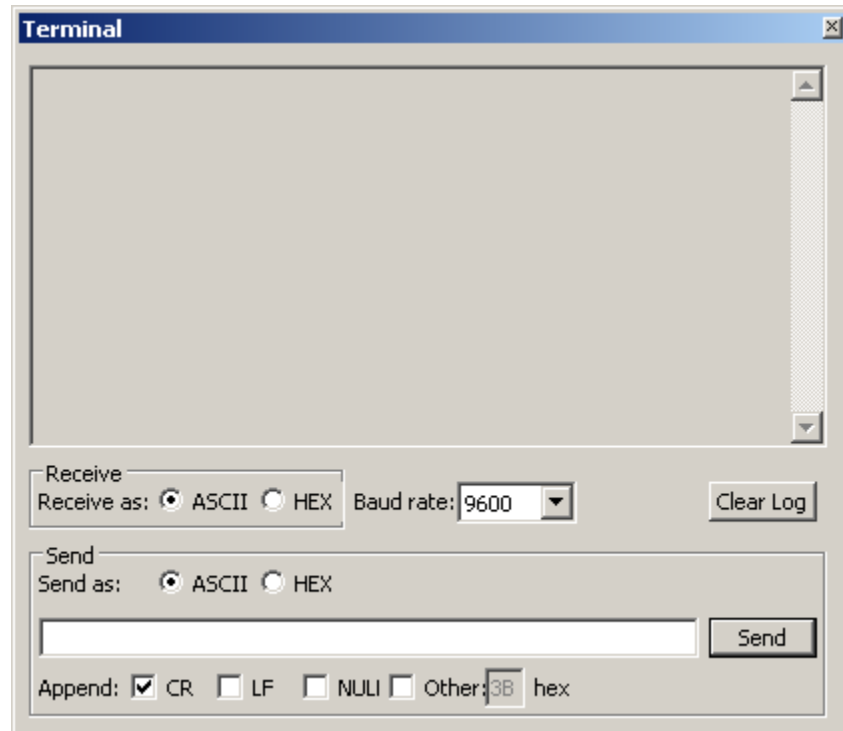
- |                                   |  |
|-----------------------------------|--|
| <b>Path/Filename</b>              | Same as in 'Single Frames'.  |
| <b>Limit number of frames to:</b> | Allows you to limit the duration of the recording by the number of frames specified.   |
| <b>Frames per Second:</b>         | Limits the frame rate of the recorded movie.   |
| <b>Learn from card</b>            | Clicking on this button causes the actual frame rate of the attached camera to be read from the card and automatically populated into the 'Frame per Second' field. This option works only if Grabbing is started. |
| <b>Compressor:</b>                | Allows you to choose between a variety of compressor implementations and options. This pull-down menu lists several different implementations of AVI compressors. Each has its own set of                          |

|  |  |
|--|--|
| <b>Freeze preview window while capturing</b> | configuration options.<br>Same as in 'Series of Frames'. |
| <b>Text Overlay</b>                          | Same as in 'Single Frames'.                              |
| <b>Accept</b>                                | Same as in 'Single Frames'.                              |
| <b>Cancel</b>                                | Same as in 'Single Frames'.                              |

## Terminal Dialog

---

The Terminal dialog allows the user to communicate with the attached camera via the Camera Link's serial interface.



- Receive as** Allows the user to select the format in which he wants received characters to be displayed.
- Baud rate** Specifies the data transfer speed of the CameraLink's serial interface. Clicking on this box causes a pull-down menu to appear. The user can then select the desired baud rate from among the choices presented, ranging from 9600 to 115,200 bits per second. This setting must match the camera's requirements.
- Clear Log** Clears the terminal window of all text.
- Send as** Allows the user to select the format in which he wants transmitted characters to be entered.
- Append** Specifies which control character should be added to the end of the command that the user entered into the Send line.
- Send** Causes the command entered into the Send line to be transmitted to the camera.

## Statistics Dialog

---

The Statistics dialog displays real-time status information about the current camera connection.

The screenshot shows a dialog box titled "Statistics" with a close button (X) in the top right corner. It is divided into three main sections: Camera, Frame Grabber, and PCI Express. Each section contains several parameters with input fields and units.

| Camera     |                 | Frame Grabber  |             |
|------------|-----------------|----------------|-------------|
| Frame rate | 466 fps         | Grabbing rate  | 467 fps     |
| Clock rate | 40 MHz          | Grabbing count | 1449 frames |
| Horiz.     | 128 clocks/line | Drop count     | 0 frames    |
| Vert.      | 256 lines/frame | Overrun count  | 0 frames    |
| Bandwidth  | 1954 Mbps       | Timestamp      | 3341009     |

| PCI Express |                |                            |            |
|-------------|----------------|----------------------------|------------|
| Link width  | 4 lane(s)      | Max payload size           | 128 bytes  |
| Link speed  | 2.5 gigabits/s | Max payload size requested | 2048 bytes |

**Camera** Displays information related to the attached camera.

**Frame rate** Displays the real-time frame rate of the attached camera as measured at the input of the FrameLink Express card.

**Clock rate** Displays the real-time Camera Link clock rate of the attached camera as measured at the input of the FrameLink Express card.

**Horiz.** Displays the number of clocks/line received from the attached camera as measured at the input of the FrameLink Express card. Note that this value represents the number of pixels/line for single tap mode. For dual tap mode, however, the number of pixels/line is twice the value displayed.

**Vert.** Displays the number of lines/frame received from the attached camera as measured at the input of the FrameLink Express card.

**Bandwidth** Displays the computed bandwidth required on the PCI Express interface in order to support the attached camera. Bandwidth is a function of the pixels/line, lines/frame, frame rate, number of taps and bit depth.

**Frame grabber** Displays information related to the frame grabber.

**Grabbing rate** Displays the real-time rate at which frames are being transferred from the card into host memory.

|                                   |   |
|-----------------------------------|---|
| <b>Grabbing count</b>             | Displays a running count of the total number of frames transferred into system memory. This counter is reset when ‘grabbing’ is stopped.  |
| <b>Drop count</b>                 | Displays a running count of the total number of dropped frames. Dropped frames are defined as frames that were received from the camera but due to a lack of host buffers could not be transferred into host memory. It is the host computer’s responsibility to provide the card with pointers into host buffers. If the host computer cannot keep up with the incoming frame rate then the card will drop frames. The primary cause of this is background applications that are competing for the host processors time and preventing it from servicing the FrameLink Express card. |
| <b>Overrun count</b>              | Displays a running count of the total number of receiver buffer overruns. Overruns are defined as pixel data that was received from the camera but due to a lack of space, in the card’s on-board receiver FIFOs, had to be discarded. Buffer overruns are an indication that the incoming pixel rate exceeds the bandwidth available on the PCI Express interface.   |
| <b>Timestamp</b>                  | Displays a running timestamp counter. Each frame that is received from the camera and transferred into host memory is time stamped. This field shows the timestamp value for the last frame processed.  |
| <b>PCI Express</b>                | Displays information related to the PCI Express bus connection.   |
| <b>Link width</b>                 | Displays the number of lanes that are connected between the card and host PC.   |
| <b>Link speed</b>                 | Displays the clock frequency of each lane.  |
| <b>Max payload size</b>           | Displays the maximum payload size that was granted to the card by the Operating System.   |
| <b>Max payload size requested</b> | Displays the payload size that the card requested to be granted to it by the Operating System.  |

**NOTE:**

If the *max payload size* granted by the Operating System is less than the *max payload size requested* by the card, then the card’s DMA performance may be compromised. If this is the case, then try increasing the payload size provided by the Operating System by modifying BIOS parameters ( if available ).

A *max payload size* of 128 Bytes/Packet will limit the DMA throughput to 5.565 Gbps. This is less than the theoretical limit, 6.8 Gbps, for a DECA camera operating with an 85 MHz clock and will result in overruns.

## Hex Pixel Dump Window

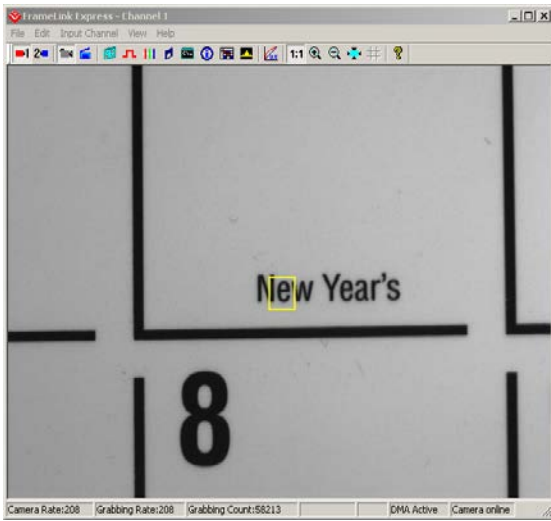
---

The Hex Pixel Dump window displays a two-dimensional table of pixel values, plotting row ( Y ) vs. column ( X ), for a bounded region of pixels. The hexadecimal value of each pixel is displayed in each cell. For monochrome formatted images, a single grayscale value is displayed per pixel. For Bayer and RGB formatted images, three values representing R, G and B are displayed per pixel. Additionally, the background color of each cell is grayscale encoded for monochrome images or color encoded for Bayer /RGB images.

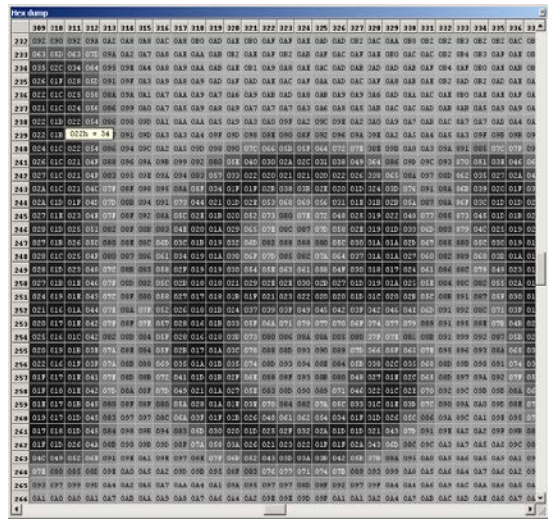
Hovering the mouse over a given pixel reveals both the pixel's hexadecimal and integer values. In the monochrome sample image below, with the mouse positioned at location 311, 239 ( X, Y ), a box is revealed showing that the value of the pixel at that location is 022 in hexadecimal and 34 in integer.

A yellow square, overlaid on the main image window, shows the position of the bounded region. Horizontal and vertical scroll bars allow the user to move the position of the bounded region of pixels anywhere within the entire frame.

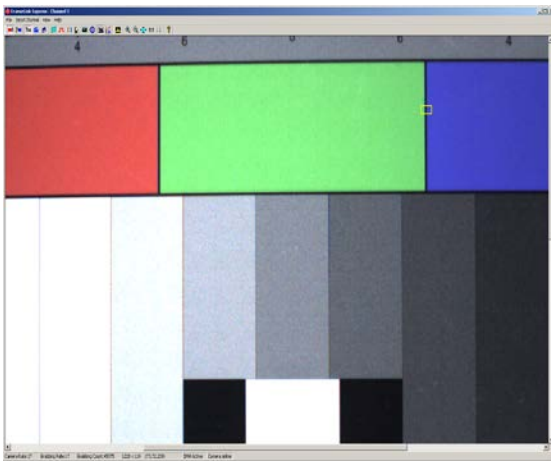
Another method of opening the Hex Pixel Dump window is to drag the mouse over the main image window while holding down the left mouse button. This creates the yellow box that defines the pixel dump's bounded region and automatically open the Hex Pixel Dump window.



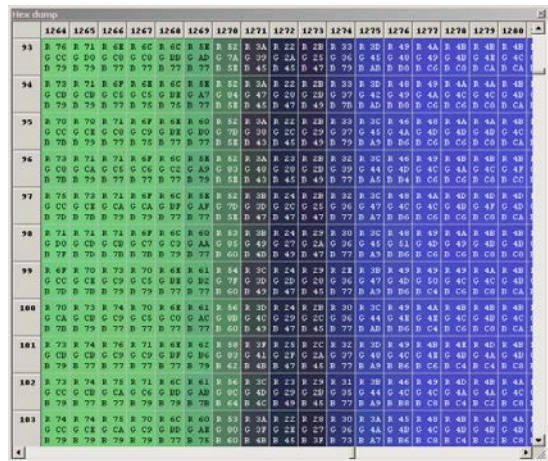
The sample monochrome image.



Hex dump for monochrome image.



The sample color image.



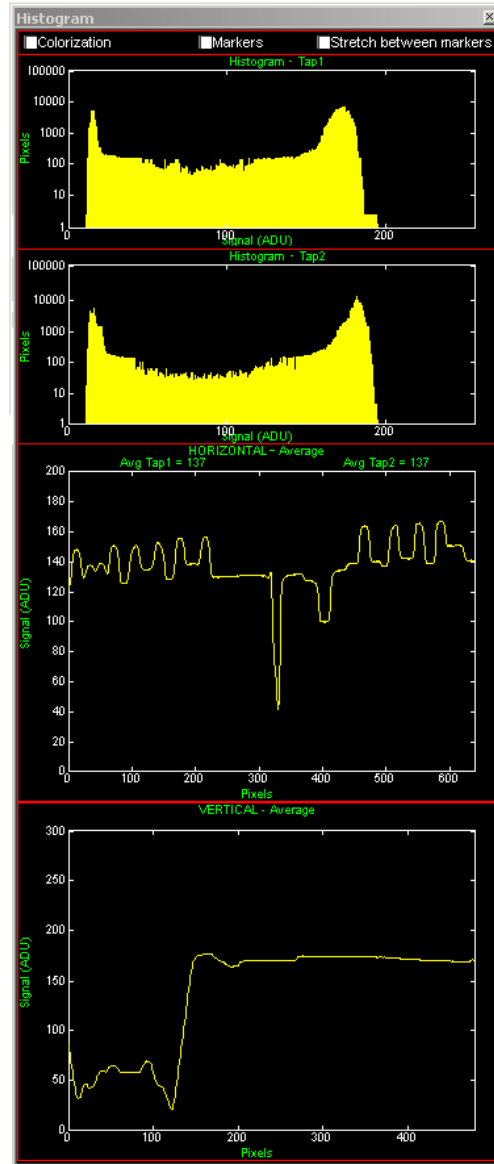
Hex dump for color image.



## Histogram Window

---

The Histogram window displays three graphs: a histogram plot, a horizontal average plot and a vertical average plot.



### Check Boxes

These features affect the way that the pixel data is altered prior to being displayed in the live preview window. For an illustration of how these features work, see ‘Examples of how to use the Histogram’ below.

### Colorization

Causes the live preview image to be ‘colorized’. Colorization results in pixels with no value ( i.e. 0 decimal ) to be displayed as ‘green’ and pixels that are saturated ( i.e. 4095 decimal in 12 bit mode ) to be displayed as ‘red’. All other pixels ( i.e. from 1 to 4094 decimal in 12 bit mode ) are displayed as normal.

**Markers**

Turns on two vertical markers, 'green' and 'red', that move along the X-axis of the Histogram plot. The 'green' marker can be moved by dragging it with the left mouse. The 'red' marker can be moved by dragging it with the right mouse. The 'green' marker defines a lower limit for the pixel value, while the 'red' marker defines an upper limit for the pixel value. All pixels with a value less than or equal to the lower limit will be converted to 0, while all pixels with a value greater than or equal to the upper limit will be converted to saturated.

For example: in 12 bit mode, the pixel values range from 0 to 4095 decimal. If the lower marker is set to 1000 then all pixels with a value between 0 and 1000 will be converted to 0. If the upper marker is set to 2000 then all pixels with a value between 2000 and 4095 will be converted to 4095.

**Stretch between markers**

Causes all pixel values lying between the lower marker and the upper marker to be 'stretched', in effect causing contrast enhancement. In the example above, the pixels with values between 1001 and 1999 will be 'stretched' so that they fill the entire range from 1 to 4094. This means that a pixel value of 1001 will be converted to 1 and a pixel value 1999 will be converted to 4094. All other pixels, values 1002 to 1998, will be scaled linearly to fill in the range.

**Histogram**

Plots the histogram of the current frame displayed in the image window as a function of pixel frequency ( Y-axis ) vs. pixel value ( X-axis ). The range of the pixel value, in the X-axis, depends on the bit depth of the camera. For example, the range is 256 for 8 bits, 1024 for 10 bits, etc. The pixel frequency represents the total number of pixels with a given pixel value. Two histogram plots are provided with the upper plot representing CameraLink tap #1 and the lower representing tap #2.

**Horizontal Average**

Plots the average value of the current frame displayed in the image window as a function of average pixel value ( Y-axis ) vs. horizontal position ( X-axis ). The average value for all pixels in a given column of the image is plotted on the Y-axis. The range of the horizontal positions, in the X-axis, depends on the number of columns in the frame.

For example, in the sample illustration, the range of the X-axis is 640 indicating that there are 640 pixels/line in the sample image. In this example, the average of all of the pixels in column number 400 is 100.

A single plot represents both taps. The averages for each tap, however, is listed at the top of the plot.

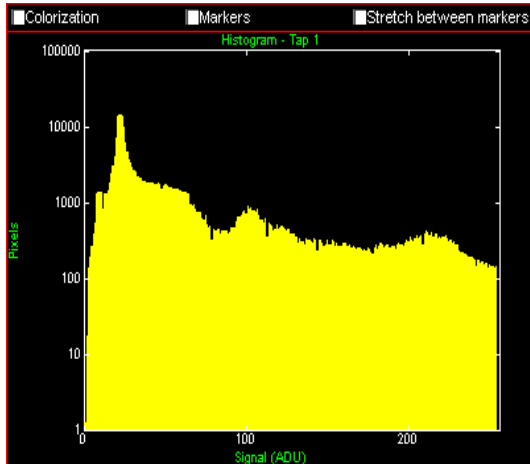
## **Vertical Average**

Plots the average value of the current frame in the image window as a function of average pixel value ( Y-axis ) vs. vertical position ( X-axis ). The average value for all pixels in a given row of the image is plotted on the Y-axis. The range of the vertical positions, in the X-axis, depends on the number of rows in the frame. For example, in the sample illustration, the range of the X-axis is 480 indicating that there are 480 lines/frame in the sample image. In this example, the average of all of the pixels in row number 100 is 50.

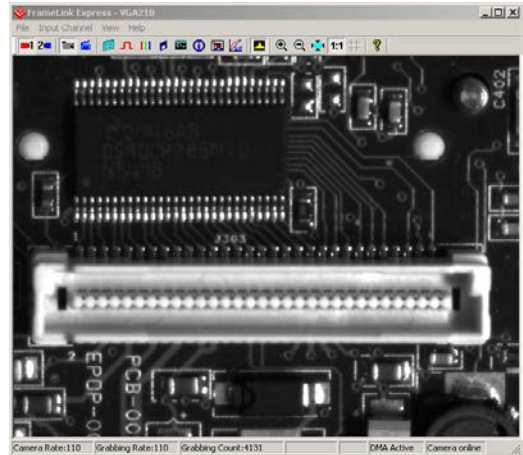
## Examples of how to use the Histogram

The examples below illustrate the effect that colorization, markers and stretching have on an image. These examples are based on a single tap image with a bit depth of 8 bits.

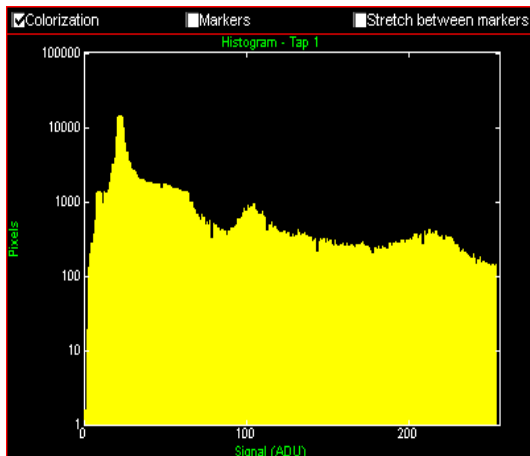
### Example using 'Colorization':



The histogram shows the distribution for the sample image.

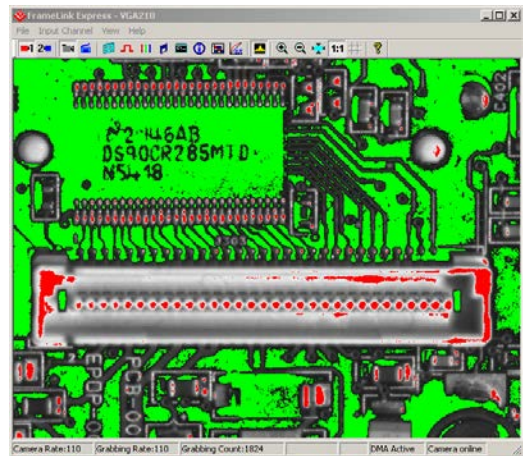


This is the original sample image.



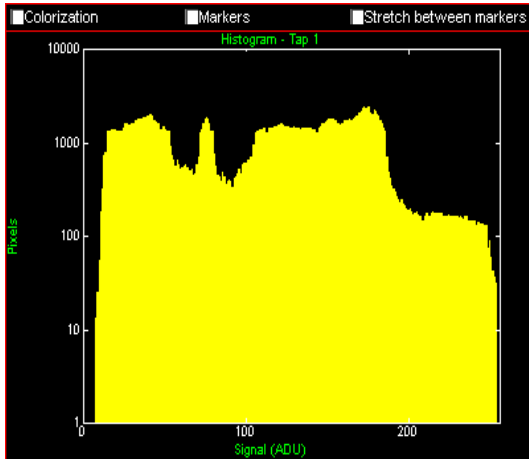
The histogram 'colorization' is turned on.

This causes all pixels with a value of 0 ( black ) to be converted to green and with a value of 255 ( white ) to be converted to red.

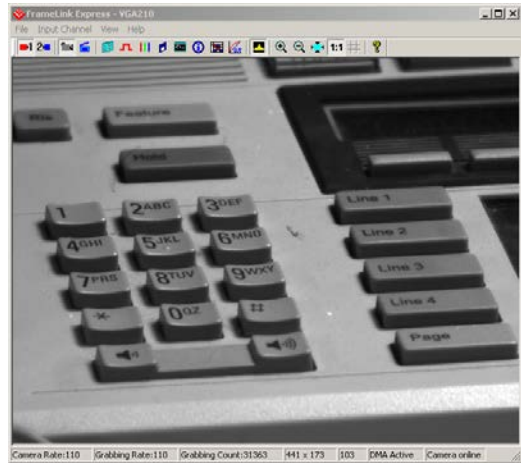


Resultant colorized image.

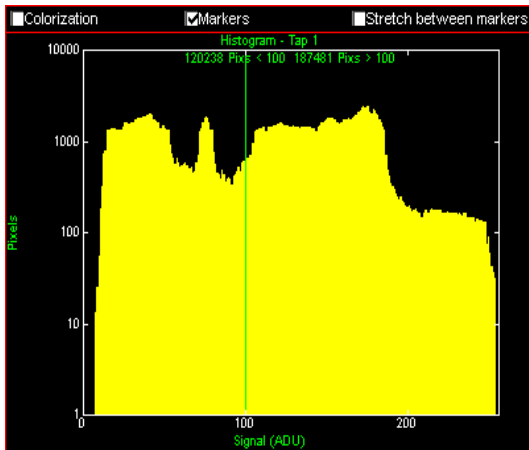
**Example using ‘Markers’ ( for single thresholding ):**



The histogram shows the distribution for the sample image.



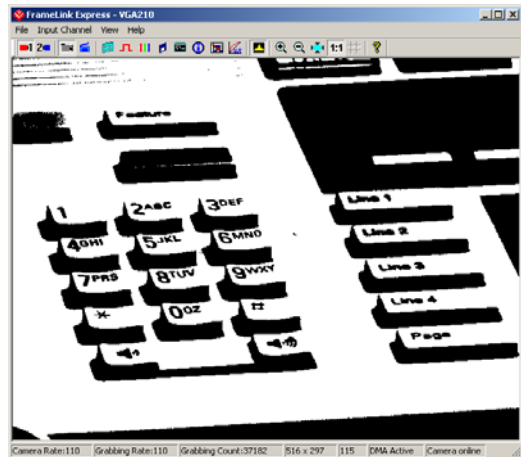
This is the original sample image.



The histogram ‘markers’ are turned on.

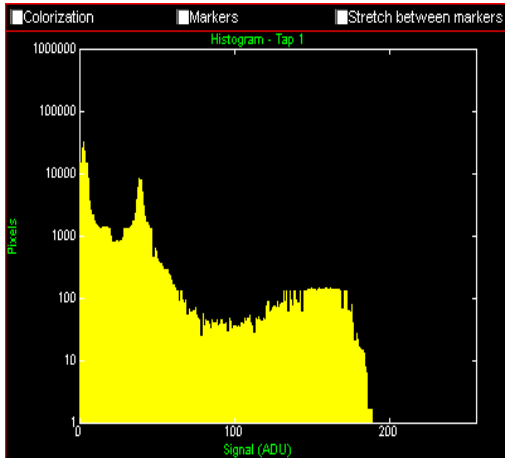
Both the lower limit marker ( green ) and upper limit marker ( red ) are set to the same pixel value of 100.

This causes all pixels with a value less than 100 to be converted to black and with a value greater than 100 to be converted to white.



Resultant black & white image with all grayscale removed.

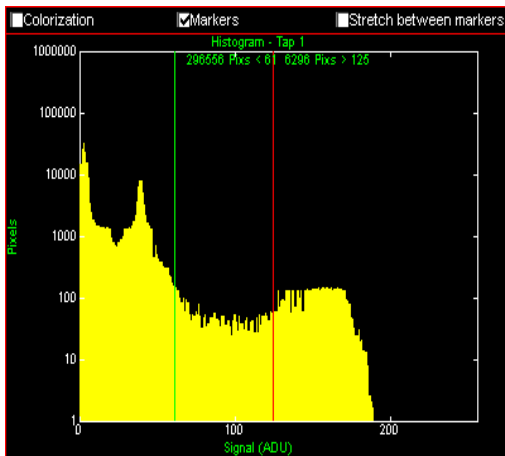
## Example using 'Markers' ( for double thresholding ):



The histogram shows the distribution for the sample image.



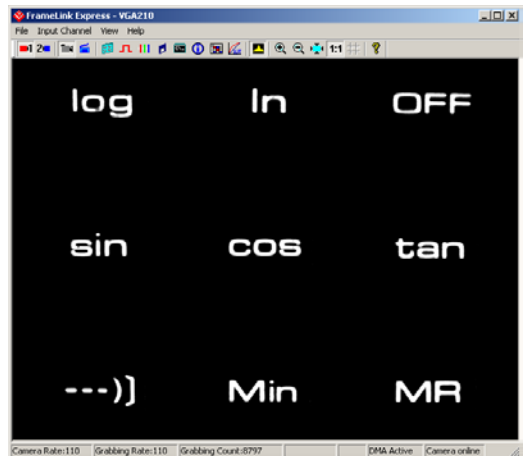
This is the original sample image.



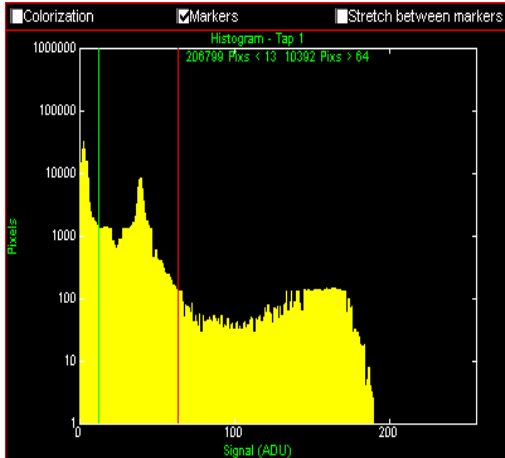
The histogram 'markers' are turned on.

The lower limit marker ( green ) is set to 61 and upper limit marker ( red ) is set to 125.

This causes all pixels with a value less than 61 to be converted to black and with a value greater than 125 to be converted to white.



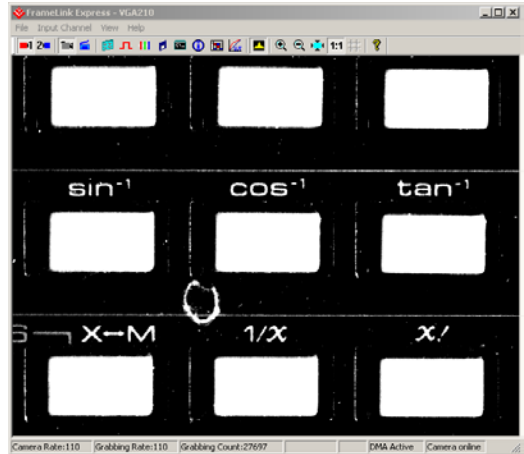
Resultant image.



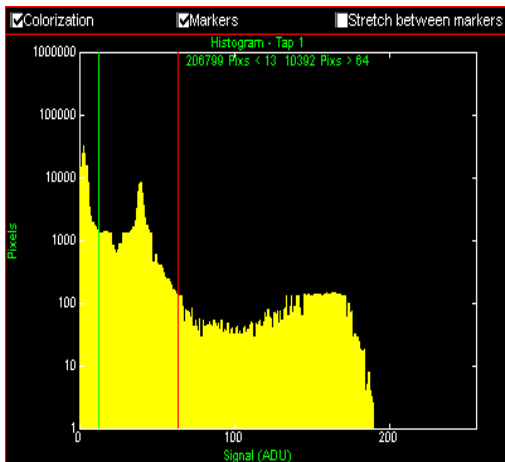
The histogram 'markers' are turned on.

The lower limit marker ( green ) is set to 13 and upper limit marker ( red ) is set to 64.

This causes all pixels with a value less than 13 to be converted to black and with a value greater than 64 to be converted to white.



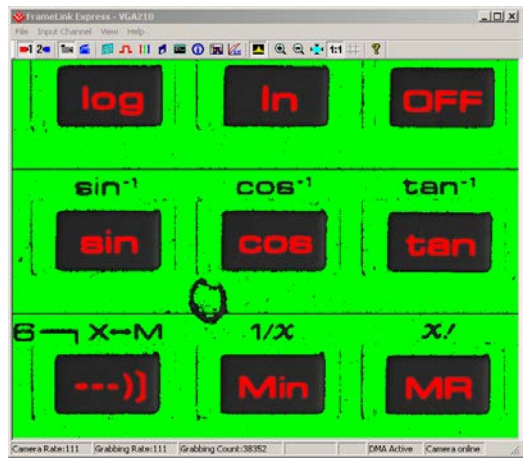
Resultant image.



The histogram 'colorization' and 'markers' are turned on.

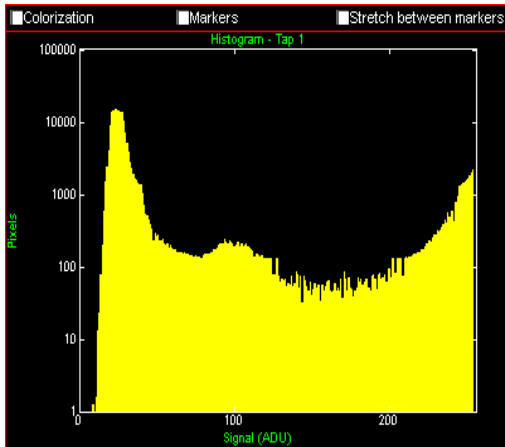
The lower limit marker ( green ) is set to 13 and upper limit marker ( red ) is set to 64.

This causes all pixels with a value less than 13 to be converted to green and with a value greater than 64 to be converted to red.

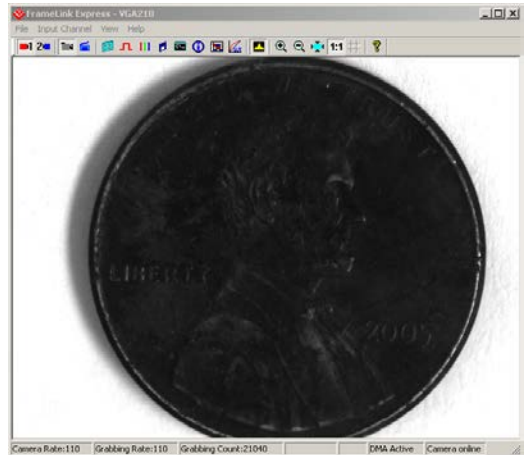


Resultant image.

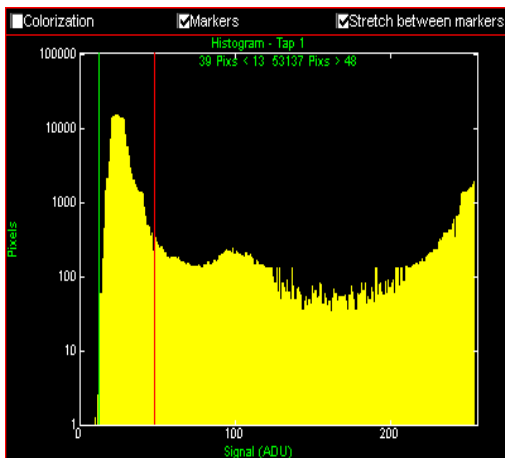
**Example using ‘Stretch between markers’ ( for contrast enhancement ):**



The histogram shows the distribution for the sample image.



This is the original sample image.



The histogram ‘Markers’ and ‘Stretch’ are turned on.

The lower limit marker ( green ) is set to 13 and the upper limit marker ( red ) is set to 48.

This causes all pixels between 13 and 48 to be stretched, all pixels with a value less than 13 to be converted to black and with a value greater than 48 to be converted to white.



Resultant contrast enhanced image.

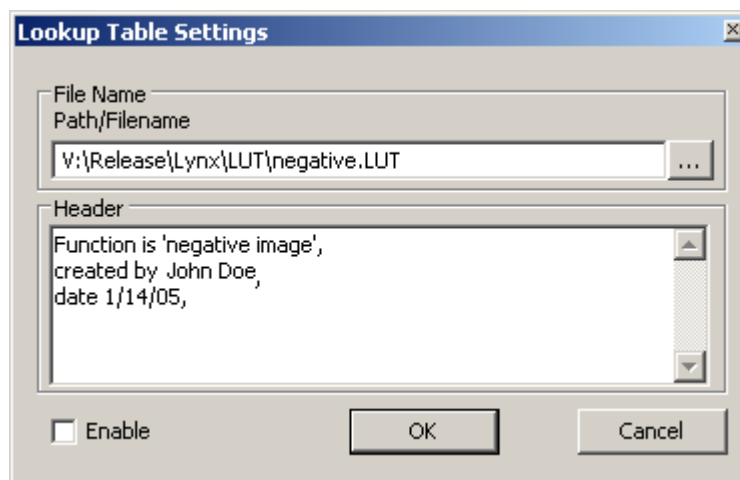


## Lookup Table Dialog

---

The Lookup Table dialog allows the user to select and enable a lookup table transfer function. The lookup table feature allows the user to modify and transform the original video data into any arbitrary value. Any 12-bit value can be transformed into any other 12-bit value. This is useful for Gamma correction, digital gain/offset, thresh-holding, etc. Refer to Appendix B for details on how to create a Lookup Table.

**Note:** A Gamma45 lookup table will be loaded by the application program by default.



### Path/Filename

This text field allows you to provide a path and filename for the lookup table file to be opened. Clicking on the ‘...’ box will cause a Windows ‘browse’ box to appear. The user can then browse to a folder and enter a file name. The filename extension, **.lut**, will automatically be added and therefore you do not need to include the filename extension.

### Header

This text window displays the header read from the LUT file. For example, in the negative.lut file illustrated in Appendix C, the header window would list the following:

```
Function is 'negative image',  
created by John Doe,  
date 1/14/05,
```

### Enable

Causes lookup table processing to be performed on received images using the selected lookup table file. The resultant image will be displayed in the main image window.

## Zoom Menu

---

The Zoom menu allows the user to select various zooming and scaling functions. The zoom menu can be invoked via the View item on the Menu bar or by right clicking the mouse over the image window.

|                                     |               |          |
|-------------------------------------|---------------|----------|
|                                     | Full screen   | F11      |
|                                     | Zoom in       | Ctrl+'+' |
|                                     | Zoom out      | Ctrl+'-' |
|                                     | Fit to window | Ctrl+0   |
|                                     | 25%           | Alt+4    |
|                                     | 50%           | Alt+2    |
| <input checked="" type="checkbox"/> | 100%          | Ctrl+1   |
|                                     | 200%          | Ctrl+2   |
|                                     | 400%          | Ctrl+4   |

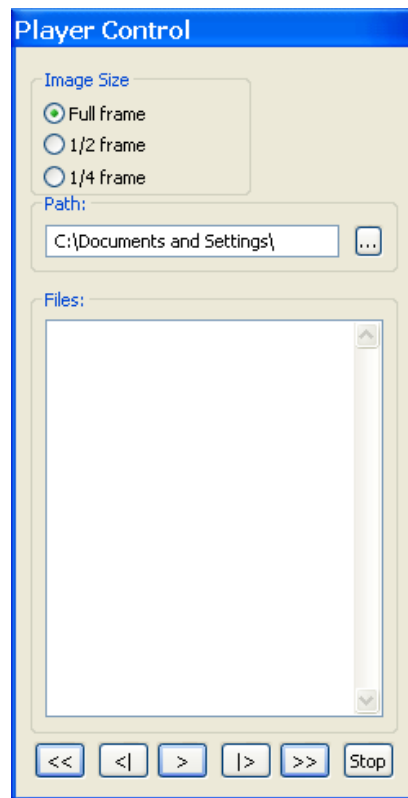
- Full screen** Causes the displayed image to be scaled to fill the entire screen. In this mode, all menu bars will be hidden. The user can hit the 'F11' key or the icon from the icon bar as shortcuts. Pressing 'F11' again or 'ESC' exits this mode.
- Zoom in** Causes the displayed image zoom to be increased. The user can hit the 'Ctrl' and '+' keys or the icon from the icon bar as shortcuts.
- Zoom out** Causes the displayed image zoom to be decreased. The user can hit the 'Ctrl' and '-' keys or the icon from the icon bar as shortcuts.
- Fit to window** Causes the displayed image to be scaled to fill the entire image window. The user can change the image window by dragging its sides or corners. Note that the Fit to Window function will maintain the aspect ratio of the original image.
- 25%** Causes the displayed image to be 25% of the original image. This scaling factor will also be applied to the saved image files.
- 50%** Causes the displayed image to be 50% of the original image. This scaling factor will also be applied to the saved image files.
- 100%** Causes the displayed image to be 100% of the original image. This scaling factor will also be applied to the saved image files.
- 200%** Causes the displayed image to be 200% of the original image. This scaling factor will also be applied to the saved image files.
- 400%** Causes the displayed image to be 400% of the original image. This scaling factor will also be applied to the saved image files.

## Player Control

---

Clicking on the 'Play Files' item under the 'File' pull-down menu at the top of the FrameLink Express main window causes two windows to appear: the 'Player Control' and 'Player Dialog' windows. These windows can be moved anywhere around the screen to suit your needs.

The Player Control window is used to select the pre-recorded image or movie files that you wish to view.



### **Image Size**

Determines the size of the Player Dialog window and the playback image. Changing from one scale to another automatically updates the Player Dialog window and image size.

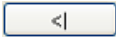
### **Path**


This text field allows you to enter the name of the folder or directory containing the image or movie files. Clicking on the '...' box will cause a Windows 'browse' box to appear.

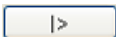
### **Files**


This box lists all of the image or movie files that are in the folder selected under 'Path'.

**Rewind**  Displays the first image in the series.

**Step Backwards**  Displays the previous frame or image. Use this button to back through individual frames of an AVI Movie. Play must be paused for this button to work on AVI Movies.

**Play**  Begins playing the AVI movie. If you are viewing JPEG or BMP images, clicking this button displays a series of images (one after another) starting from the current file selected in the Player Control dialog.

**Step Forward**  Displays the next frame or image. Use this button to advance through individual frames of an AVI Movie. Play must be paused for this button to work on AVI Movies.

**Fast Forward**  Displays the last image in the series.

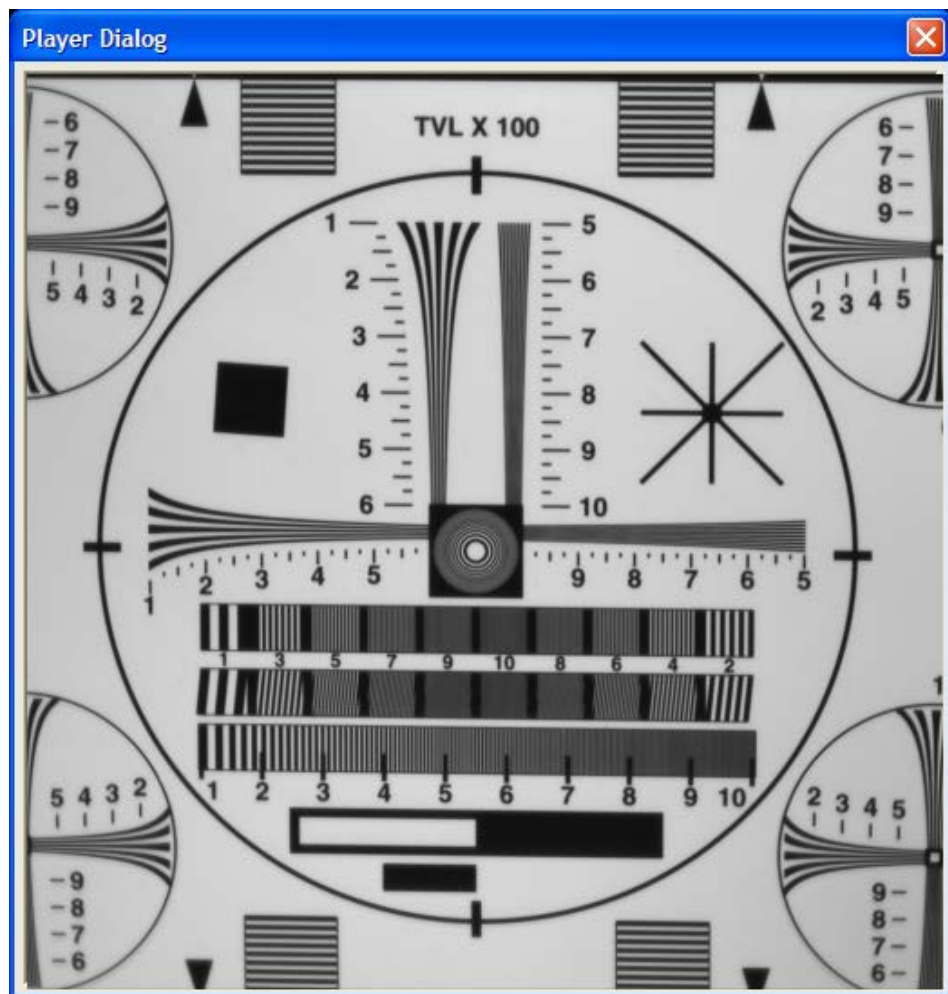
**Stop**  Halts current playback.

## Player Dialog

---

The Player Dialog window appears when the user selects the 'Play Files' item under the 'File' pull-down menu at the top of the FrameLink Express main window. The Player Dialog window provides the primary area for viewing playback of pre-recorded images or movies. This window can be moved anywhere around the screen to suit your needs.

The size of the window ( and image ) is determined by the size of the image file selected in the 'Player Control' window and can be scaled using the 'Image Size' option. For example, if the user selects an image file that was produced by a 640x480 resolution camera, then the 'Full frame' window size will be 640x480. In this example, selecting '½ frame' produces a window size of 320x240 and selecting '¼ frame' produces a size of 160x120.



# *Chapter* **5**



## **Electrical Interfaces**

This chapter contains information on the FrameLink Express's connectors.

## Camera Link Connector

---

The CameraLink connectors are shielded, right angle, through hole, 26 position, female, SDR ( shrunk delta ribbon ) style connectors. Two such connectors are provided on the card. The first connector is used for a Channel #1 Base configuration while the second is used for either a Channel #2 Base or Channel #1 Medium configuration. Note that in the Channel #1 Medium configuration, the second connector's CC[4:1] and SerTC/SerTFG signals are unused.

| Pin # | Cable name   | Signal name  |
|-------|--------------|--------------|
| 1     | Inner Shield | Inner Shield |
| 2     | PAIR11-      | CC4-         |
| 3     | PAIR10+      | CC3+         |
| 4     | PAIR9-       | CC2-         |
| 5     | PAIR8+       | CC1+         |
| 6     | PAIR7+       | SerTFG+      |
| 7     | PAIR6-       | SerTC-       |
| 8     | PAIR5+       | X3+          |
| 9     | PAIR4+       | Xclk+        |
| 10    | PAIR3+       | X2+          |
| 11    | PAIR2+       | X1+          |
| 12    | PAIR1+       | X0+          |
| 13    | Inner Shield | Inner Shield |
| 14    | Inner Shield | Inner Shield |
| 15    | PAIR11+      | CC4+         |
| 16    | PAIR10-      | CC3-         |
| 17    | PAIR9+       | CC2+         |
| 18    | PAIR8-       | CC1-         |
| 19    | PAIR7-       | SerTFG-      |
| 20    | PAIR6+       | SerTC+       |
| 21    | PAIR5-       | X3-          |
| 22    | PAIR4-       | Xclk-        |
| 23    | PAIR3-       | X2-          |
| 24    | PAIR2-       | X1-          |
| 25    | PAIR1-       | X0-          |
| 26    | Inner Shield | Inner Shield |

**Table 6 – Camera Link Connector Pin-out**

Note that the Camera Link connector pin-out for the frame grabber is 180 degrees rotated from the pin-out for the camera.

## ExpressCard Connector ( VCE-CLEX01/CLEX02 only )

---

The ExpressCard connector is a surface mount, right angle, 26 position, female connector.

| Pin # | Signal name | In/Out | Note     |
|-------|-------------|--------|----------|
| 1     | GND         |        |          |
| 2     | USBD-       | I/O    | not used |
| 3     | USBD+       | I/O    | not used |
| 4     | CPUSB#      | O      | not used |
| 5     | reserved    |        |          |
| 6     | reserved    |        |          |
| 7     | SMBCLK      | I/O    | not used |
| 8     | SMBDATA     | I/O    | not used |
| 9     | +1.5V       |        |          |
| 10    | +1.5V       |        |          |
| 11    | WAKE#       | O      | 3        |
| 12    | 3.3VAUX     |        | 5        |
| 13    | PERST#      | I      | 4        |
| 14    | +3.3V       |        |          |
| 15    | +3.3V       |        |          |
| 16    | CLKREQ#     | O      | 2        |
| 17    | CPPE#       | O      | 1        |
| 18    | REFCLK-     | I      |          |
| 19    | REFCLK+     | I      |          |
| 20    | GND         |        |          |
| 21    | PERn0       | O      |          |
| 22    | PERp0       | O      |          |
| 23    | GND         |        |          |
| 24    | PETn0       | I      |          |
| 25    | PETp0       | I      |          |
| 26    | GND         |        |          |

**Table 7 – ExpressCard Connector Pin-out**

Notes:

- 1 – CPPE# indicates to the host that the card has been inserted.
- 2 – CLKREQ# indicates to the host that the card is requesting that the REFCLK be provided. This is a Power Management function and is not implemented on the FrameLink Express.
- 3 – WAKE# is used to notify the host that it should re-apply power to the card. This is a Power Management function and is not implemented on the FrameLink Express.
- 4 – PERST# is a reset signal driven by the host to reset the card.
- 5 – 3.3VAUX is used to power the WAKE# circuitry. This is a Power Management function and is not implemented on the FrameLink Express.



## PCIe x1 Connector ( VCE-CLPCIe01/CLPCIe02 only )

The PCIe x1 connector is a vertical, edge-finger, two-sided, 36 position connector. Side B is on the primary ( component ) side and Side A is on the secondary ( solder ) side. Both pins A1 and B1 are closet to the I/O bracket.

| Side B |             |        |      | Side A |             |        |      |
|--------|-------------|--------|------|--------|-------------|--------|------|
| Pin #  | Signal name | In/Out | Note | Pin #  | Signal name | In/Out | Note |
| B1     | +12V        |        |      | A1     | PRSNT1#     | O      | 5    |
| B2     | +12V        |        |      | A2     | +12V        |        |      |
| B3     | +12V        |        |      | A3     | +12V        |        |      |
| B4     | GND         |        |      | A4     | GND         |        |      |
| B5     | SMBCLK      | I      | 1    | A5     | JTAG_TCK    |        | 2    |
| B6     | SMBDAT      | I/O    | 1    | A6     | JTAG_TDI    |        | 2    |
| B7     | GND         |        |      | A7     | JTAG_TDO    |        | 2    |
| B8     | +3.3V       |        |      | A8     | JTAG_TMS    |        | 2    |
| B9     | JTAG_TRST#  | I      | 2    | A9     | +3.3V       |        |      |
| B10    | 3.3Vaux     |        | 3    | A10    | +3.3V       |        |      |
| B11    | WAKE#       | O      | 2    | A11    | PERST#      | I      | 6    |
| B12    | reserved    |        |      | A12    | GND         |        |      |
| B13    | GND         |        |      | A13    | REFCLK+     | I      |      |
| B14    | PETp0       | I      | 7    | A14    | REFCLK-     | I      |      |
| B15    | PETn0       | I      | 7    | A15    | GND         |        |      |
| B16    | GND         |        |      | A16    | PERp0       | O      | 7    |
| B17    | PRSNT2#     | O      | 5    | A17    | PERn0       | O      | 7    |
| B18    | GND         |        |      | A18    | GND         |        |      |

**Table 8 – PCIe x1 Connector Pin-out**

Notes:

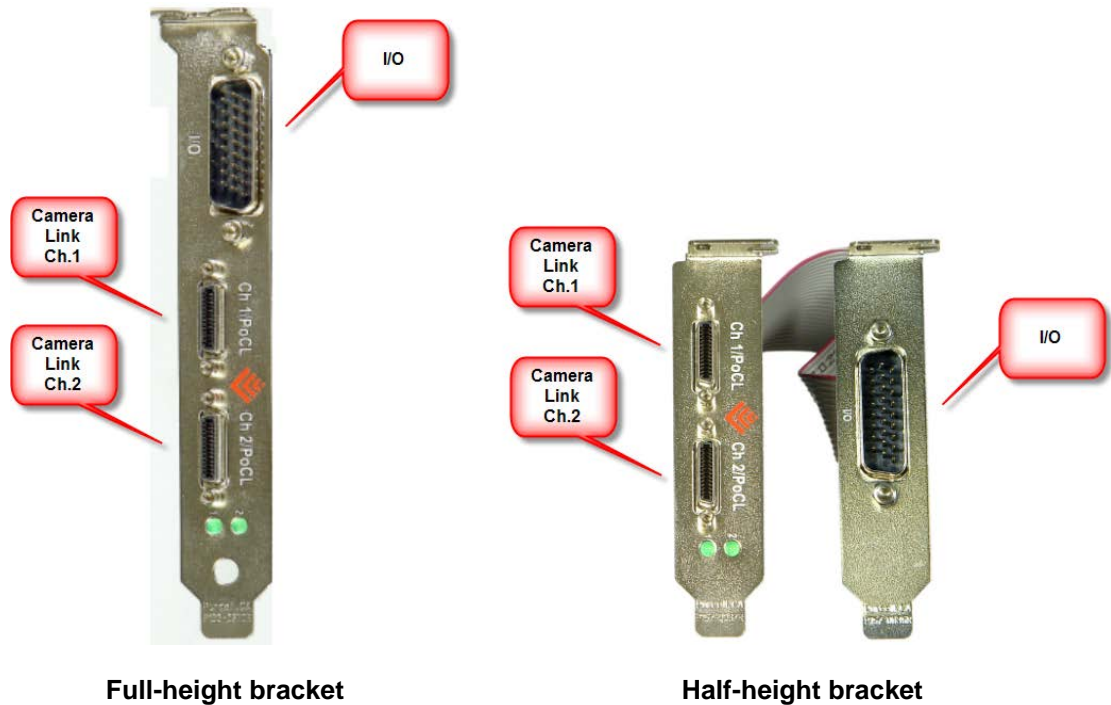
- 1 – The SMB Bus is not implemented.
- 2 – The JTAG interface is not implemented.
- 3 – 3.3Vaux is used to power the WAKE# circuitry. This is a Power Management function and is not implemented.
- 4 – WAKE# is used to notify the host that it should re-apply power to the card. This is a Power Management function and is not implemented.
- 5 – PRSNT1# is tied to PRSNT2# and is used by the host to sense card insertion/removal.
- 6 – PERST# is a reset signal driven by the host to reset the card.
- 7 – Direction for transmit and receive signals are relative to the host.

## I/O Connector ( VCE-CLPCIe02 only )

The I/O connector consists of an internal board mounted 26 pin header and an external bracket mounted HDD-26 jack. A cable assembly connects the internal and external connectors. The pin assignments of the internal and external connectors are one-to-one ( i.e. pin#1 of the internal connector is connected to pin#1 of the external connector ). The external connector can be mounted on either a full-height bracket or a half-height bracket. Use of the half-height bracket requires an adjacent PC expansion slot.

| Pin # | Signal Name | Pin # | Signal Name |
|-------|-------------|-------|-------------|
| 1     | IN1+        | 2     | OUT1+       |
| 3     | IN1-        | 4     | OUT1-       |
| 5     | IN2+        | 6     | OUT2+       |
| 7     | IN2-        | 8     | OUT2-       |
| 9     | IN3+        | 10    | OUT3+       |
| 11    | IN3-        | 12    | OUT3-       |
| 13    | IN4+        | 14    | OUT4+       |
| 15    | IN4-        | 16    | OUT4-       |
| 17    | RXD1        | 18    | TXD1        |
| 19    | RXD2        | 20    | TXD2        |
| 21    | Ext_VCC1    | 22    | Ext_VCC3    |
| 23    | Ext_VCC2    | 24    | Ext_VCC4    |
| 25    | GND         | 26    | GND         |

**Table 9 – I/O Connector Pin-out**



# Chapter 6

## Specifications

### Video Source

Camera Link interface ( Base configuration using a single SDR26 connector or Medium configuration using two SDR26 connectors ).

Base modes supported:

1x8, 2x8, 3x8, 1x10, 2x10, 1x12, 2x12, 1x14, 1x16 and RGB24

Medium modes supported: all Base modes plus

4x8, 3x10, 4x10, 3x12, 4x12, RGB30 and RGB36.

Camera Link clock rates from 20 MHz to 85 MHz.

Color filters supported: Monochrome, Bayer and TrueSense.

UART serial interface, for camera configuration and monitoring, formatted as: no parity, 8 data bits, 1 stop bit and baud rates from 9600 to 115,200 bps.

Four discrete LVDS differential outputs, CC[4:1], for camera control.

### Physical Dimensions

|                |  |
|----------------|--|
| VCE-CLPCIE01   | : 84mm x 69mm ( 3.3 x 2.7 in ).              |
| VCE-CLPCIE02   | : 168mm x 69mm ( 6.6 x 2.7 in ).             |
| ExpressCard/54 | : 108mm x 54mm x 18mm ( 4.3 x 2.1 x .7 in ). |
| ExpressCard/34 | : 108mm x 34mm x 18mm ( 4.3 x 1.3 x .7 in ). |

### Weight

|                |                           |
|----------------|---------------------------|
| VCE-CLPCIE01   | : 45.0 grams ( 1.59 oz )  |
| VCE-CLPCIE02   | : 110.0 grams ( 3.88 oz ) |
| ExpressCard/54 | : 53.6 grams ( 1.91 oz )  |
| ExpressCard/34 | : 35.9 grams ( 1.27 oz )  |

### Electrical Characteristics

|                    |             |
|--------------------|-------------|
| Operating voltage: | 3.3V +/- 5% |
| Operating current: | 500mA       |

### Operating Environment

|                        |                    |
|------------------------|--------------------|
| Operating temperature: | 0°C to 65°C        |
| Relative humidity:     | 90% non-condensing |

### Regulatory

FCC 15 part B, CE, RoHS

# Appendix

# A

## Serial Communications

The FrameLink Express provides a Camera Link compliant serial communications channel. This is an ASYNC interface operating at a user selectable BAUD rate ( set via the Camera Parameters dialog ), with 1 start bit, 8 data bits, 1 stop bit, no parity and no handshake.

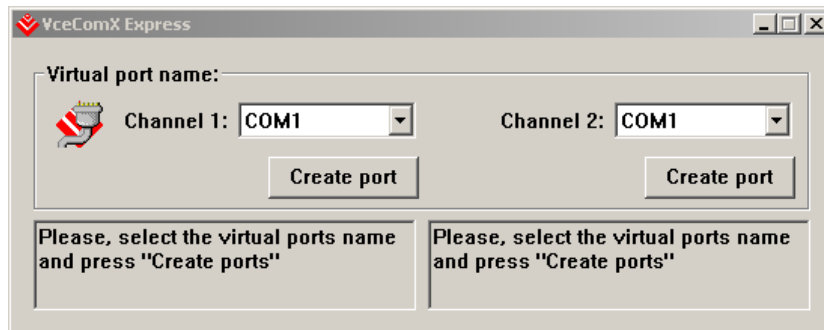
### Clseripx.dll

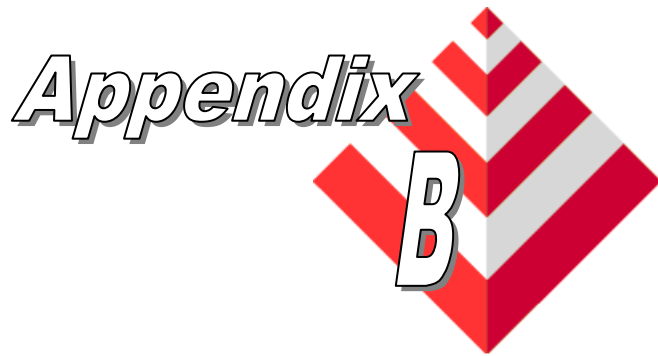
Any standard camera configuration software can access this serial interface by using the FrameLink Express's clseripx.dll file ( located in the c:/WINDOWS/system32 folder for WinXP or c:/WINNT/system32 folder for Win2000). The clseripx.dll is fully compliant with v1.2 of the Camera Link specification.

### COM port emulation

Alternatively, if the camera configuration software does not provide an interface to the Camera Link clser\*\*\*.dll but only supports standard COM ports, then the user can invoke our VceComEX.exe COM port emulator. This software will emulate a PC COM port allowing any terminal emulator or camera configuration tool to access the FrameLink Express serial interface.

To create a virtual COM port, simply run the VceComEX.exe program. Then select the port number from the pull-down list and click on 'Create Port'. You can now begin using the virtual COM port in you terminal or camera configuration software. **NOTE: You must not exit the VceComEX program while it is in use.** When you are done using the COM port, then click on 'Delete Port' and 'Exit'.





## Creating Look Up Tables

This appendix provides a reference on how to create a lookup table using both an ASCII editor and an Excel spreadsheet.

### Overview

The Lookup Table file can be created using any standard ASCII text editor or by using Microsoft Excel. Additionally, any spreadsheet or mathematical program capable of generating a comma delimited file can be used.

### Using an ASCII text editor

A custom LUT ( lookup table ) can be prepared using any ASCII text editor. Alternatively, any spreadsheet program (i.e. Microsoft Excel) can be used by converting the spreadsheet into a comma delimited (.csv ) file. In either case, the file must be renamed to include the .lut extension. The .lut file has three main sections: 'Header', 'Options' and 'Table'.

#### Header Section

The 'Header' section is a free text area of up to 256 ASCII characters. Each line of the header section must be terminated in a comma.

#### Options Section

The 'Options' section includes a 'Depth=x' parameter where x indicates the pixel bit depth of 8, 10, 12, 14 or 16 bits. If the 'Options' section is omitted, then the bit depth will default to 12 bits.

**Note:** The Options Section and Depth parameter are only available in software versions 1.4.0.211 or higher. In previous versions of the software, the LUT is fixed to operate in 12 bit mode with 4096 entries in the table.

#### Table Section

The 'Table' section of the file contains an array of 256, 1024, 4096, 16384 or 65536 lines ( for bit depths of 8, 10, 12, 14 or 16 respectively ) with each line containing an input value followed by a comma and an output value. The input values represent incoming pixels and the output values represent what each incoming pixel should be converted into as an output pixel.

## LUT Format

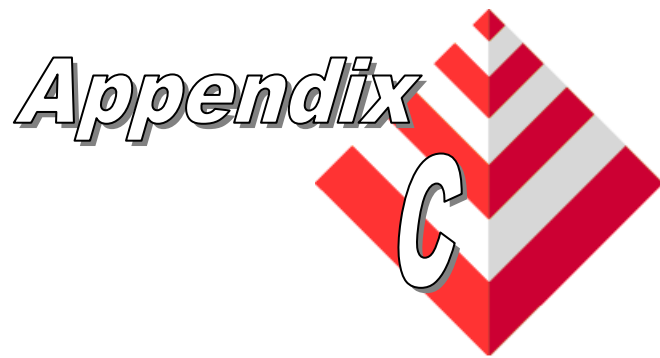
```
-- Look Up Table input file example,  
-- lines beginning with two dashes are comments,  
-- and are ignored by parser,  
:Header,  
Function is 'negative image' for 12-bit pixels,  
created by John Doe,  
date 1/14/05,  
:Options  
-- the Depth token can be set to 8, 10, 12, 14 or 16  
Depth=12  
:Table,  
--input output,  
0,4095  
1,4094  
2,4093  
3,4092  
4,4091  
:  
4095,0
```

## Using Microsoft Excel

The .LUT file can be created in Excel as follows:

- 1 - create the spreadsheet as shown below ( note that since the “:Options” line is missing, the bit depth will default to 12 bits and therefore 4096 rows are required in the table ).
- 2 - add the necessary equations into the output cells to generate the transfer function required.
- 3 - save the file as a .csv ( comma delimited format ).
- 4 - rename the .csv file to an extension of .lut.

|    | A   | B      | C | D | E | F |
|----|---|--------|---|---|---|---|
| 1  | -- Look Up Table input file example             |        |   |   |   |   |
| 2  | -- lines beginning with two dashes are comments |        |   |   |   |   |
| 3  | -- and are ignored by parser                    |        |   |   |   |   |
| 4  | :Header   |        |   |   |   |   |
| 5  | Function is 'negative image'                    |        |   |   |   |   |
| 6  | created by John Doe                             |        |   |   |   |   |
| 7  | date 1/14/05                                    |        |   |   |   |   |
| 8  | :Table  |        |   |   |   |   |
| 9  | -- input  | output |   |   |   |   |
| 10 | 0   | 4095   |   |   |   |   |
| 11 | 1   | 4094   |   |   |   |   |
| 12 | 2   | 4093   |   |   |   |   |
| 13 | 3   | 4092   |   |   |   |   |
| 14 | 4   | 4091   |   |   |   |   |
| 15 | :   | :      |   |   |   |   |
| 16 | 4095  | 0      |   |   |   |   |
| 17 |   |        |   |   |   |   |
| 18 |   |        |   |   |   |   |
| 19 |   |        |   |   |   |   |
| 20 |   |        |   |   |   |   |



## Programmable Logic Controller

This appendix applies to the VCE-CLPCie02 card only and provides a reference on how to use the PLC functionality provided by the FrameLink Express.

### Overview

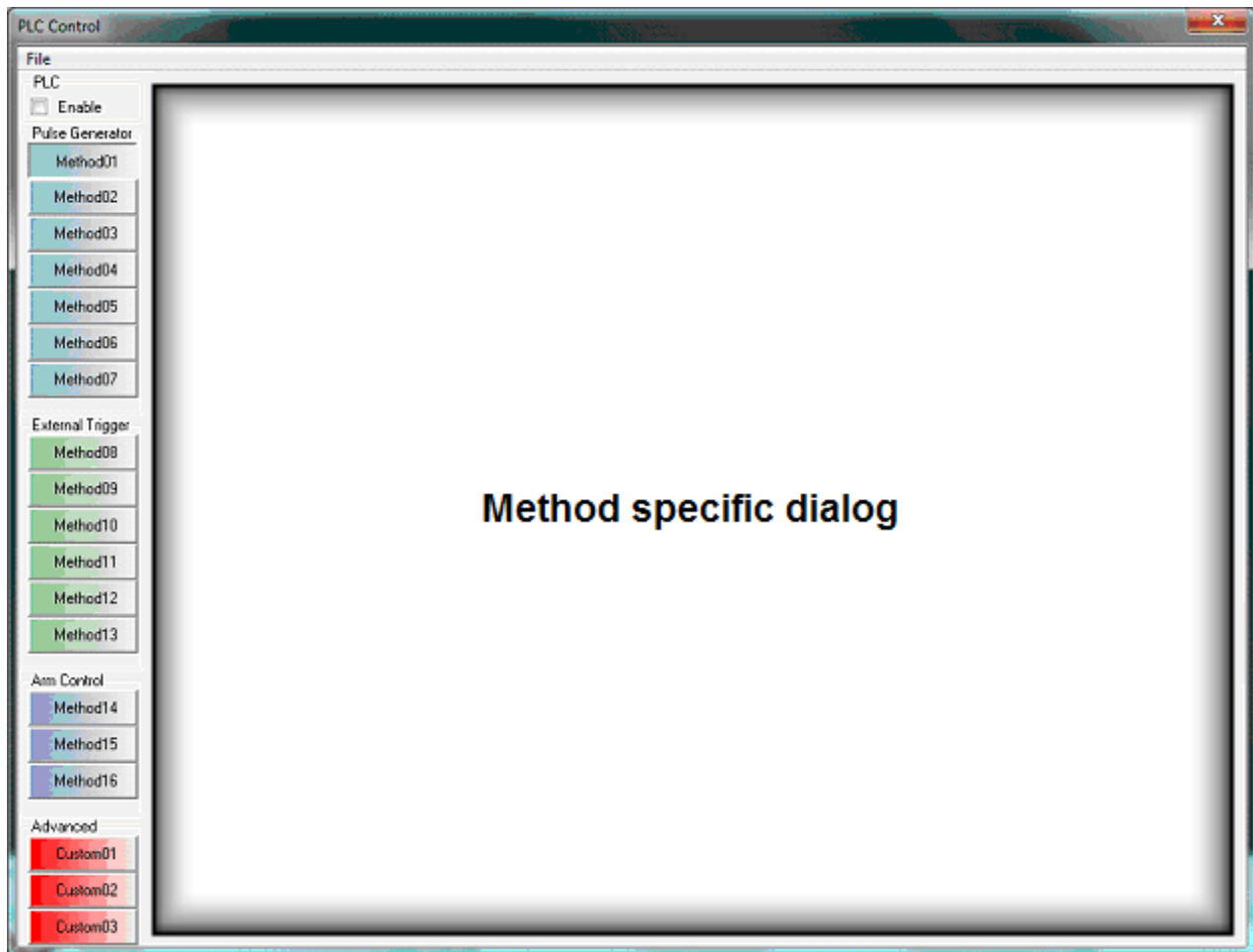
The PLC provides a comprehensive set of programmable functional blocks which allow the user to create arbitrary waveforms. These waveforms are typically used for:

- Triggering an attached camera
- Providing exposure signals to an attached camera
- Triggering an external lighting device
- Arm'ing the frame grabber to capture images

## Common Dialog

---

The common PLC dialog includes a “File” pull-down menu, “Enable” check box, a list of “pre-defined” methods (Method01 – Method16), a list of “custom” methods (Custom01 – Custom03) and an area for the method specific dialog.



### File

Clicking on this item reveals a pull-down menu, which allows the user to “load” or “save” PLC configurations files. The files are text files with a .plc extension and follow an XML-like structure.

### Load

Loads a previously saved PLC configuration file. Clicking on this box will cause a Windows “browse” box to appear. The user can then browse to the folder and file he wishes to open. The program will then open the selected file, parse it and populate the fields in all methods of the PLC dialogs.



|                    |  |
|--------------------|--|
| Save               | Saves the current configuration for all methods as a PLC configuration file. Clicking on this box will cause a Windows “browse” box to appear. The user can then browse to a folder and enter a file name. The program will then create a .PLC file using the values in all methods of the PLC dialogs and write it to the disk.   |
| Enable             | The procedure is for the user to select a given method, configure its fields and then check the <b>Enable</b> box. Checking the <b>Enable</b> box causes the contents of the GUIs fields to be transferred into the hardware and the PLC to start operating. While <b>Enable</b> is checked, the GUI’s fields are rendered un-editable and the user is prevented from switching to a different method. Un-checking the <b>Enable</b> box stops the PLC’s operation and places the GUI back into the edit mode. |
| Methods list       | Selecting a given method, displays the GUI for that method and allows it’s fields to be edited.  |
| Predefined Methods | The PLC can be programmed by a novice user via a set of predefined “methods”. Sixteen methods are provided allowing the user to program the PLC for many of the most common use cases. The methods abstract the underlying details of programming the PLC’s functional blocks and provide an easy to use interface.  |
| Custom Methods     | The PLC can also be programmed by an experienced user via an advanced set of custom methods. The custom method GUIs provide access “under-the-hood” to each of the PLC’s functional blocks allowing the user to create his own method. The ability to create three custom methods is provided. The methods created can be saved for later recall and use.  |

## Predefined Methods

---

The pre-defined methods are separated into three groups: Pulse Generator, External Trigger and Arm Control.

### Pulse Generator

These methods produce free-running, periodic, asynchronous pulses. The pulses can be routed to the GPIO OUT[4:1] signals or the Camera Link's CC[4:1] signals. The OUT or CC signals can be connected to a camera that supports an external triggering capability.

### External Trigger

These methods produce pulses that are synchronized and controlled by an external input. The external input is received via the GPIO IN[4:1] signals. The pulses produced by these methods can then be routed to the GPIO OUT[4:1] or the Camera Link's CC[4:1] signals. The OUT or CC signals can be connected to a camera that supports an external triggering capability.

### Arm Control

These methods are used to “arm” the frame grabber's capture engine and to qualify when it acquires images from the camera. This is useful when the attached camera does not support an external trigger ( i.e. it always provides free-running images ) yet the user wants to synchronize frame capture via an external signal. The arm methods use an external input received via the GPIO IN[4:1] signals to determine when and how to capture images from the camera.

# Method #1

Method #1 programs the PLC to produce a free-running, periodic pulse. The pulse can then be routed to a GPIO OUT[4:1] or CL CC[4:1] output.

The screenshot displays the 'PLC Control' software window. On the left, a sidebar contains several sections: 'File', 'PLC' (with an 'Enable' checkbox), 'Pulse Generator' (with buttons for Method01 through Method07), 'External Trigger' (with buttons for Method08 through Method13), 'Arm Control' (with buttons for Method14 through Method16), and 'Advanced' (with buttons for Custom01 through Custom03). The main area features a timing diagram with four horizontal axes: 'PgTrg' (a periodic square wave), 'Output Signal (integration pulse)' (a pulse whose width is labeled 'exposure time'), 'camera' (with two shaded boxes labeled 'frame delivered'), and 'frame grabber' (with two shaded boxes labeled 'frame acquired'). Below the diagram is a 'Description' box stating: 'This method produces a free-running asynchronous periodic integration pulse to the camera. The width of the integration pulse represents the exposure time.' The configuration panel below the description includes: 'Output signal:' with a dropdown set to 'Out1'; 'Output polarity:' with a dropdown set to 'High'; 'Frame period:' with a text box containing '100' and a dropdown set to 'mSec'; 'Frame rate:' with a text box containing '10.000' and a dropdown set to 'Hz'; and 'Exposure time:' with a text box containing '25' and a dropdown set to 'mSec'. At the bottom right of the window are 'Start' and 'Stop' buttons.

**Figure C.1 – PLC Method #1**

## Method #2

Method #2 programs the PLC to produce two free-running, periodic pulses. The pulses can then be routed to a GPIO OUT[4:1] or CL CC[4:1] output.

**PLC Control**

File  
PLC  
 Enable  
Pulse Generator  
Method01  
Method02  
Method03  
Method04  
Method05  
Method06  
Method07

External Trigger  
Method08  
Method09  
Method10  
Method11  
Method12  
Method13

Arm Control  
Method14  
Method15  
Method16

Advanced  
Custom01  
Custom02  
Custom03

**Timing Diagram:**

- PgTrg: Shows a periodic square wave pulse.
- Output Signal (integration pulse): Shows two consecutive pulses within each frame period.
- camera: Shows 'frame delivered' blocks corresponding to the integration pulses.
- frame grabber: Shows 'frame acquired' blocks corresponding to the integration pulses.
- Labels: 'frame period', 'pulse width', and 'exposure time' are indicated with arrows.

**Description:**

This method produces two free-running periodic consecutive integration pulses to the camera. The time interval between the start of the two pulses represents the exposure time.

**Configuration:**

- Output signal: CC1
- Output polarity: Low
- Frame period: 100 mSec
- Frame rate: 10.000 Hz
- Exposure time: 25 mSec
- Integration pulse: 10 mSec

Start Stop

**Figure C.2 – PLC Method #2**

## Method #3

Method #3 programs the PLC to produce two free-running, periodic pulses. The pulses can then be routed to the GPIO OUT[4:1] or CL CC[4:1] outputs.

The screenshot displays the 'PLC Control' software window. On the left, a sidebar lists methods under three categories: 'Pulse Generator' (Method01-07), 'External Trigger' (Method08-13), and 'Arm Control' (Method14-16). Below these is an 'Advanced' section with 'Custom01', 'Custom02', and 'Custom03'. The main area features a timing diagram with five traces: 'PgTrg' (a periodic square wave), 'Output Signal 1 (integration pulse)' (a pulse whose width is labeled 'exposure time' and whose period is 'frame period'), 'Output Signal 2 (VD pulse)' (a pulse whose delay is 'VD pulse delay' and width is 'VD pulse width'), 'camera' (showing 'frame delivered' pulses), and 'frame grabber' (showing 'frame acquired' pulses). Below the diagram is a 'Description' box stating: 'This method produces a free-running periodic integration pulse on one output followed by a VD pulse on another output. The width of the integration pulse represents the exposure time.' The configuration panel below contains the following settings: Output signal 1: CC1; Output 1 polarity: High; Output signal 2: CC2; Output 2 polarity: Low; Frame period: 100 mSec; Frame rate: 10.000 Hz; Exposure time: 30 mSec; VD pulse delay: 20 mSec; VD pulse width: 10 mSec. At the bottom right are 'Start' and 'Stop' buttons.

**Figure C.3 – PLC Method #3**

## Method #4

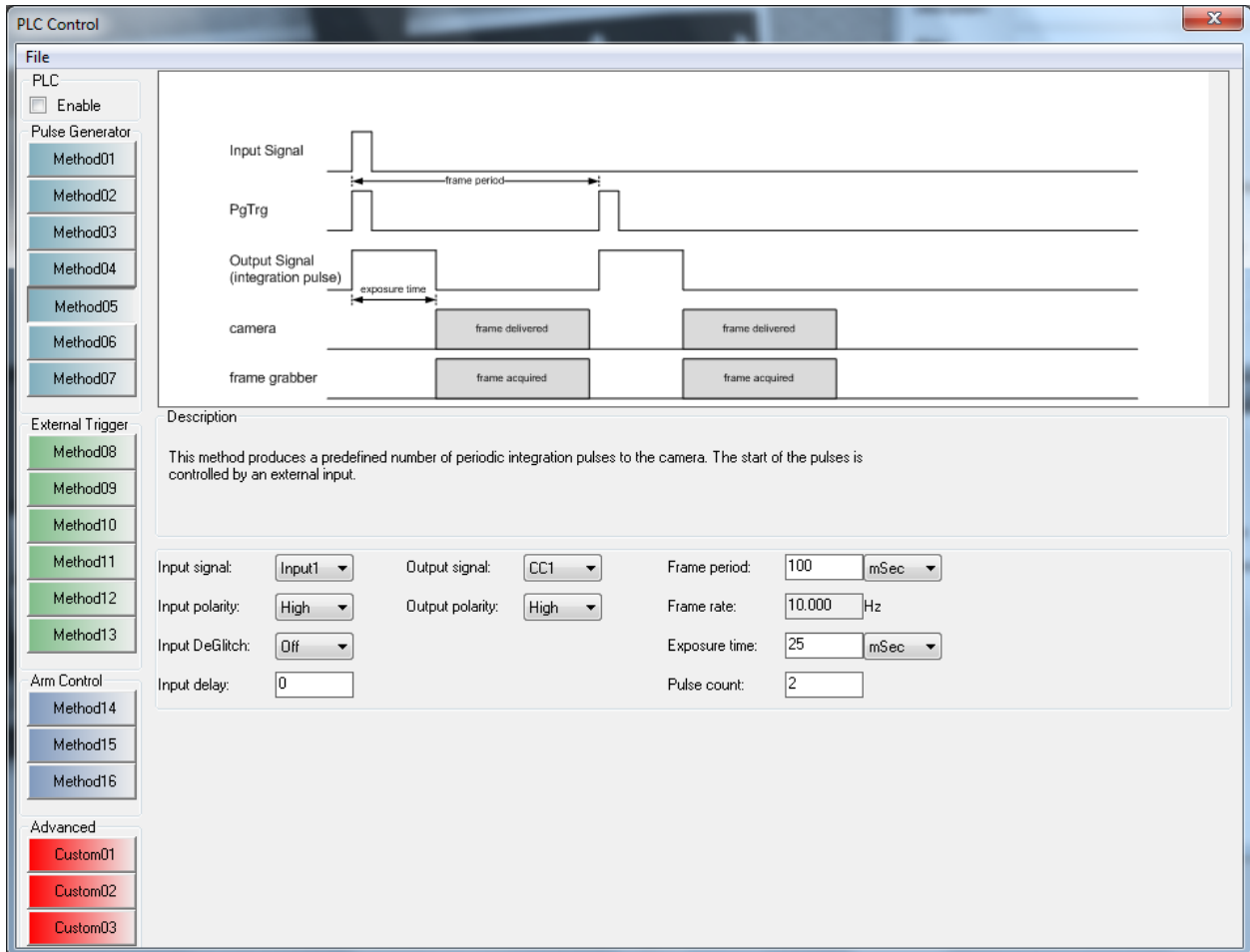
Method #4 programs the PLC to produce two free-running, periodic pulses. The pulses can then be routed to the GPIO OUT[4:1] or CL CC[4:1] outputs.

The screenshot displays the 'PLC Control' software window. On the left, there is a sidebar with a 'File' menu and several sections: 'PLC' (with an 'Enable' checkbox), 'Pulse Generator' (containing Method01 through Method07), 'External Trigger' (containing Method08 through Method13), 'Arm Control' (containing Method14 through Method16), and 'Advanced' (containing Custom01 through Custom03). The main area features a timing diagram with five traces: 'PgTrg' (a periodic square wave), 'Output Signal 1 (integration pulse)' (a pulse whose width is labeled 'pulse width'), 'Output Signal 2 (VD pulse)' (a pulse whose width is labeled 'VD pulse width'), 'camera' (showing 'frame delivered' pulses), and 'frame grabber' (showing 'frame acquired' pulses). The 'exposure time' is indicated as the interval between the start of the integration pulse and the start of the VD pulse. Below the diagram is a 'Description' box stating: 'This method produces a free-running periodic integration pulse on one output followed by a VD pulse on another output. The time interval between the start of the two pulses represents the exposure time.' The configuration panel below the description includes: 'Output signal 1: CC1', 'Output 1 polarity: High', 'Output signal 2: CC2', 'Output 2 polarity: Low', 'Frame period: 100 mSec', 'Frame rate: 10.000 Hz', 'Exposure time: 50 mSec', 'Integration pulse: 30 mSec', and 'VD pulse width: 10 mSec'. At the bottom right, there are 'Start' and 'Stop' buttons.

**Figure C.4 – PLC Method #4**

## Method #5

Method #5 programs the PLC to produce a programmable number of periodic pulses. The pulse train is started by the receipt of an external trigger via a GPIO IN[4:1] input. The pulse produced can then be routed to a GPIO OUT[4:1] or CL CC[4:1] output. A debounce or deglitch filter can be applied to the input signal.



**PLC Control**

File

PLC

Enable

Pulse Generator

Method01

Method02

Method03

Method04

Method05

Method06

Method07

External Trigger

Method08

Method09

Method10

Method11

Method12

Method13

Arm Control

Method14

Method15

Method16

Advanced

Custom01

Custom02

Custom03

Input Signal

PgTrg

Output Signal (integration pulse)

camera

frame grabber

frame period

exposure time

frame delivered

frame acquired

Description

This method produces a predefined number of periodic integration pulses to the camera. The start of the pulses is controlled by an external input.

Input signal:  Output signal:  Frame period:  mSec

Input polarity:  Output polarity:  Frame rate:  Hz

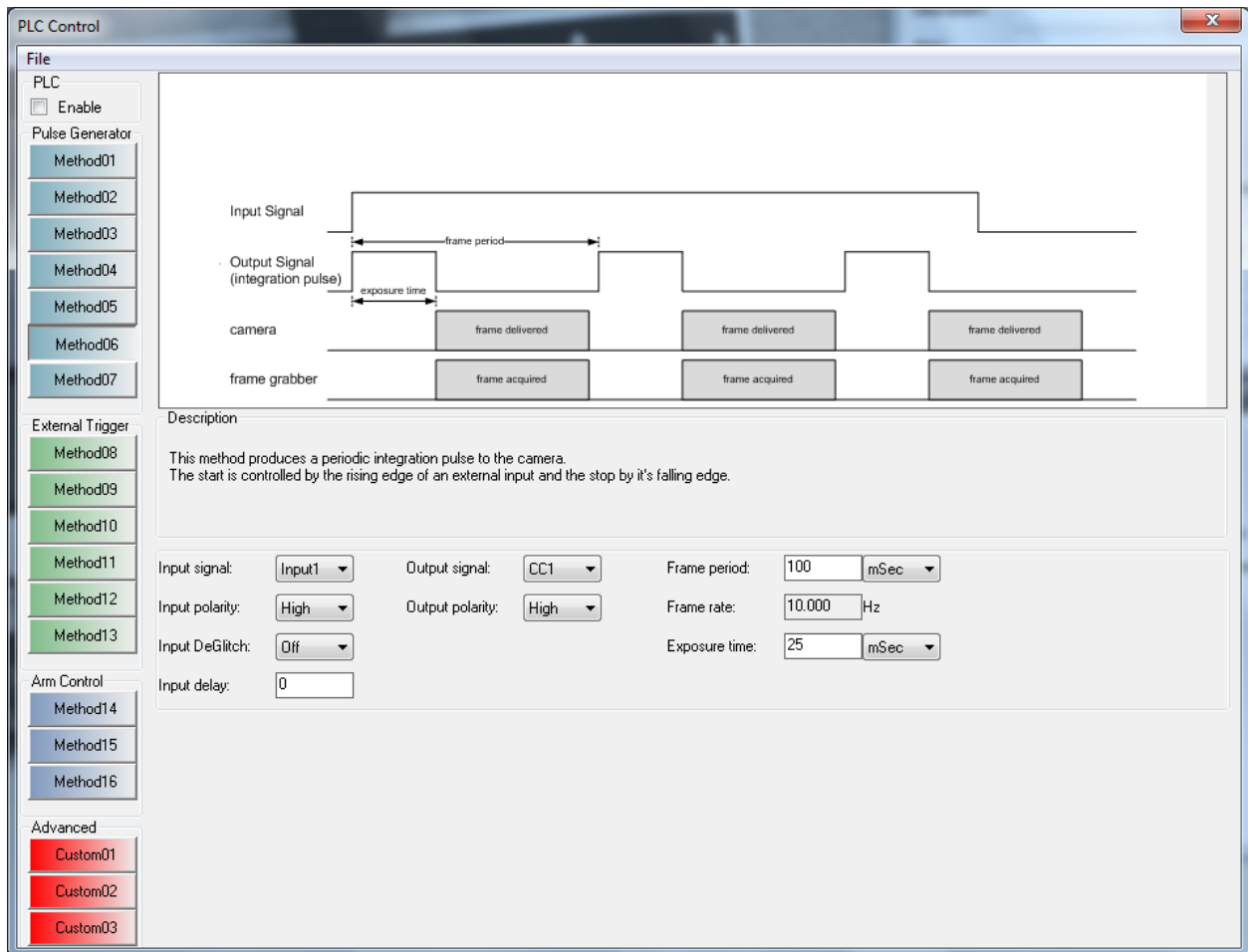
Input DeGlitch:  Exposure time:  mSec

Input delay:  Pulse count:

**Figure C.5 – PLC Method #5**

## Method #6

Method #6 programs the PLC to produce a periodic pulse qualified by an external trigger. The pulse train is started/stopped by the presence/absence of an external trigger via a GPIO IN[4:1] input. The pulse produced can then be routed to a GPIO OUT[4:1] or CL CC[4:1] output. A debounce or deglitch filter can be applied to the input signal.



**PLC Control**

File

PLC

Enable

Pulse Generator

Method01

Method02

Method03

Method04

Method05

Method06

Method07

External Trigger

Method08

Method09

Method10

Method11

Method12

Method13

Arm Control

Method14

Method15

Method16

Advanced

Custom01

Custom02

Custom03

Input Signal

Output Signal (integration pulse)

camera

frame grabber

frame period

exposure time

frame delivered

frame acquired

Description

This method produces a periodic integration pulse to the camera. The start is controlled by the rising edge of an external input and the stop by its falling edge.

Input signal: Input1    Output signal: CC1    Frame period: 100 mSec

Input polarity: High    Output polarity: High    Frame rate: 10.000 Hz

Input DeGlitch: Off    Exposure time: 25 mSec

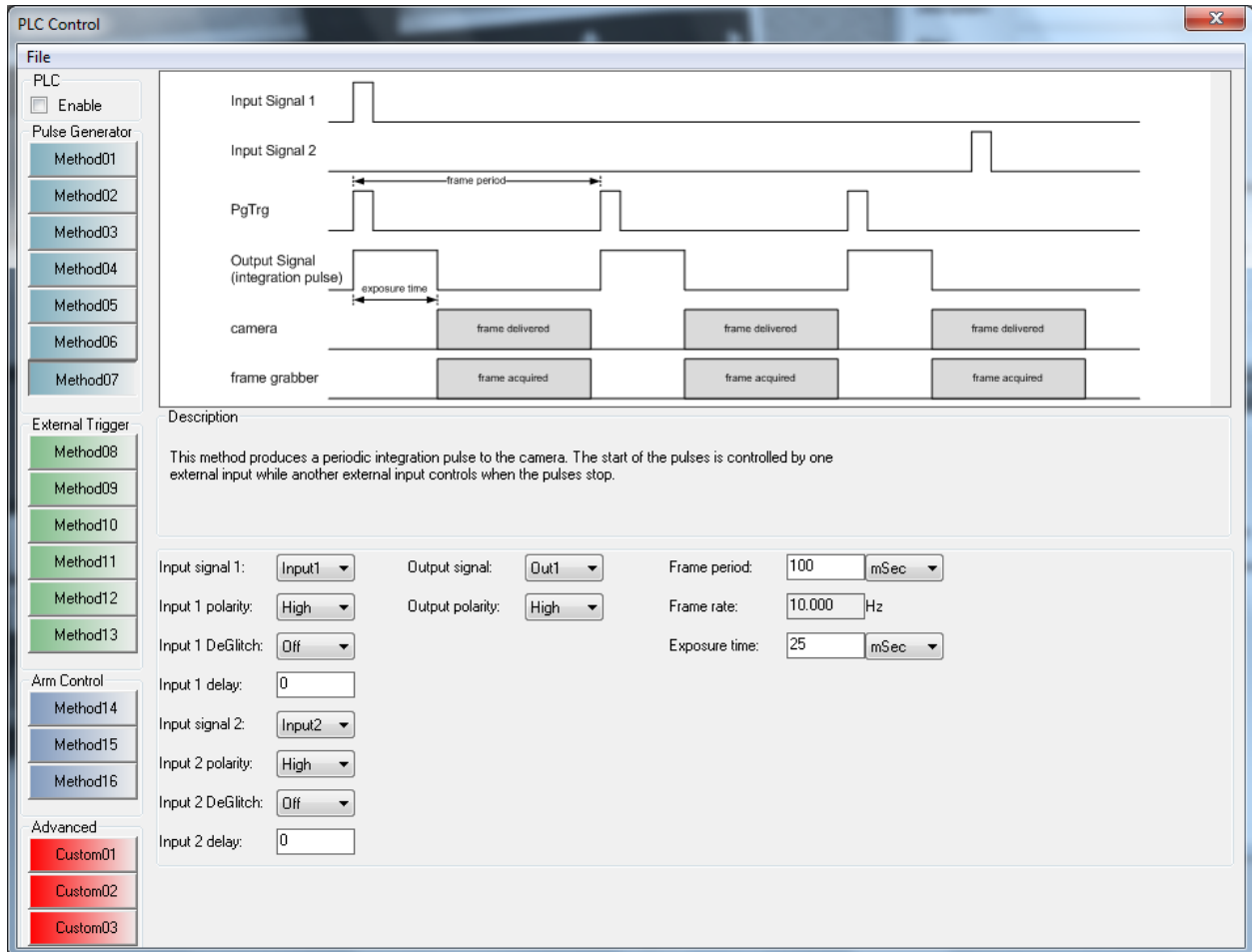
Input delay: 0

**Figure C.6 – PLC Method #6**



## Method #7

Method #7 programs the PLC to produce a periodic pulse qualified by two external triggers. The pulse train is started by the receipt of the first signal and stopped by the receipt of the second signal. The external trigger signals are received via a GPIO IN[4:1] input. The pulse produced can then be routed to a GPIO OUT[4:1] or CL CC[4:1] output. A debounce or deglitch filter can be applied to the input signals.



**Figure C.7 – PLC Method #7**

## Method #8

Method #8 programs the PLC to route an external trigger signal to an output. The external trigger signal is received via a GPIO IN[4:1] input and then routed to a GPIO OUT[4:1] or CL CC[4:1] output. A debounce or deglitch filter can be applied to the input signal.

The screenshot shows the 'PLC Control' software interface. On the left, there is a sidebar with several sections: 'PLC' (with an 'Enable' checkbox), 'Pulse Generator' (with buttons for Method01 through Method07), 'External Trigger' (with buttons for Method08 through Method13), 'Arm Control' (with buttons for Method14 through Method16), and 'Advanced' (with buttons for Custom01 through Custom03). The main area displays a timing diagram with four horizontal axes: 'Input Signal', 'Output Signal (integration pulse)', 'camera', and 'frame grabber'. The 'Input Signal' shows a rectangular pulse. The 'Output Signal' shows a pulse that starts at the beginning of the input pulse and has a duration labeled 'exposure time'. The 'camera' axis shows a shaded box labeled 'frame delivered' that occurs during the output pulse. The 'frame grabber' axis shows a shaded box labeled 'frame acquired' that also occurs during the output pulse. Below the diagram is a 'Description' box containing the text: 'This method produces an integration pulse to the camera. The width of the pulse represents the exposure time and is controlled by an external signal.' At the bottom of the main area, there are configuration settings: 'Input signal:' (dropdown menu set to 'Input1'), 'Output signal:' (dropdown menu set to 'CC1'), 'Input polarity:' (dropdown menu set to 'High'), 'Output polarity:' (dropdown menu set to 'High'), 'Input DeGlitch:' (dropdown menu set to 'Off'), and 'Input delay:' (text input field set to '0').

**Figure C.8 – PLC Method #8**

## Method #9

Method #9 programs the PLC to route an external trigger signal to an output. The external trigger signal is received via a GPIO IN[4:1] input, is stretched by a programmable amount of time and then routed to a GPIO OUT[4:1] or CL CC[4:1] output. A debounce or deglitch filter can be applied to the input signal.

The screenshot displays the 'PLC Control' software window. On the left sidebar, the 'External Trigger' section is active, with 'Method08' selected. The main area features a timing diagram with four horizontal axes: 'Input Signal', 'Output Signal (integration pulse)', 'camera', and 'frame grabber'. The 'Input Signal' shows a single high pulse. The 'Output Signal' shows a wider pulse labeled 'exposure time'. The 'camera' axis shows a grey box labeled 'frame delivered' occurring during the exposure time. The 'frame grabber' axis shows a grey box labeled 'frame acquired' also occurring during the exposure time. Below the diagram is a 'Description' box: 'This method produces an integration pulse to the camera. The start of the pulse is controlled by an external input. The width of the pulse represents the exposure time.' At the bottom, configuration parameters are set: 'Input signal: Input1', 'Output signal: CC1', 'Exposure time: 25 mSec', 'Input polarity: High', 'Output polarity: High', 'Input DeGlitch: Off', and 'Input delay: 0'.

**Figure C.9 – PLC Method #9**

## Method #10

Method #10 programs the PLC to route an external trigger signal to an output. The external trigger signal is received via a GPIO IN[4:1] input, is delayed and stretched by a programmable amount of time and then routed to a GPIO OUT[4:1] or CL CC[4:1] output. A debounce or deglitch filter can be applied to the input signal.

The screenshot shows the 'PLC Control' software window. On the left, there is a sidebar with several sections: 'PLC' with an 'Enable' checkbox; 'Pulse Generator' with buttons for Method01 through Method07; 'External Trigger' with buttons for Method08 through Method13; 'Arm Control' with buttons for Method14 through Method16; and 'Advanced' with buttons for Custom01 through Custom03. The main window area is divided into three parts. The top part is a timing diagram with five horizontal axes: 'Input Signal', 'Output Signal (integration pulse)', 'camera', 'frame delivered', and 'frame grabbed'. The 'Input Signal' shows a single high pulse. The 'Output Signal' shows a pulse that starts after a delay (labeled 'exposure delay') and has a duration (labeled 'exposure time'). The 'camera' axis shows a grey box labeled 'frame delivered' corresponding to the output pulse. The 'frame grabbed' axis shows a grey box labeled 'frame acquired' corresponding to the frame delivered. The middle part is a 'Description' box containing the text: 'This method produces an integration pulse to the camera. The start of the pulse is controlled by an external input and is delayed. The width of the pulse represents the exposure time.' The bottom part is a configuration area with the following settings: 'Input signal:' dropdown set to 'Input1'; 'Output signal:' dropdown set to 'CC1'; 'Exposure delay:' input field '15' and dropdown 'mSec'; 'Input polarity:' dropdown set to 'High'; 'Output polarity:' dropdown set to 'High'; 'Exposure time:' input field '10' and dropdown 'mSec'; 'Input DeGlitch:' dropdown set to 'Off'; and 'Input delay:' input field '0'.

**Figure C.10 – PLC Method #10**

## Method #11

Method #11 programs the PLC to produce two programmable pulses. The pulse train is started by the receipt of an external trigger via a GPIO IN[4:1] input. The pulse produced can then be routed to a GPIO OUT[4:1] or CL CC[4:1] output. A debounce or deglitch filter can be applied to the input signal.

The screenshot shows the 'PLC Control' software window. On the left sidebar, the 'External Trigger' section has 'Method11' selected. The main area contains a waveform diagram with four traces: 'Input Signal' (a single pulse), 'Output Signal (integration pulse)' (two consecutive pulses), 'camera' (a grey bar labeled 'frame delivered' corresponding to the second pulse), and 'frame grabber' (a grey bar labeled 'frame acquired' corresponding to the second pulse). Below the diagram is a 'Description' box: 'This method produces two consecutive integration pulses to the camera. The start of the pulses is controlled by an external input. The time interval between the start of the two pulses represents the exposure time.' At the bottom, configuration parameters are set: Input signal: Input1, Output signal: CC1, Exposure time: 100 mSec, Input polarity: High, Output polarity: Low, Integration pulse: 10 mSec, and Input delay: 0.

**Figure C.11 – PLC Method #11**

## Method #12

Method #12 programs the PLC to produce two programmable pulses. The pulse train is started by the receipt of an external trigger via a GPIO IN[4:1] input. The pulses produced can then be routed to the GPIO OUT[4:1] or CL CC[4:1] outputs. A debounce or deglitch filter can be applied to the input signal.

**PLC Control**

File

PLC

Enable

Pulse Generator

Method01

Method02

Method03

Method04

Method05

Method06

Method07

External Trigger

Method08

Method09

Method10

Method11

Method12

Method13

Arm Control

Method14

Method15

Method16

Advanced

Custom01

Custom02

Custom03

Input Signal

Output Signal 1 (integration pulse)

Output Signal 2 (VD pulse)

camera

frame grabber

exposure time

VD pulse delay

VD pulse width

frame delivered

frame acquired

Description

This method produces an integration pulse on one output followed by a VD pulse on another output. The start of the pulses is controlled by an external input. The width of the integration pulse represents the exposure time.

Input signal: Input1 Output signal 1: CC1 Exposure time: 75 mSec

Input polarity: High Output 1 polarity: High VD pulse delay: 40 mSec

Input DeGlitch: Off Output signal 2: CC2 VD pulse width: 25 mSec

Input delay: 0 Output 2 polarity: Low

**Figure C.12 – PLC Method #12**

## Method #13

Method #13 programs the PLC to produce two programmable pulses. The pulse train is started by the receipt of an external trigger via a GPIO IN[4:1] input. The pulses produced can then be routed to the GPIO OUT[4:1] or CL CC[4:1] outputs. A debounce or deglitch filter can be applied to the input signal.

The screenshot displays the PLC Control software interface for Method #13. The interface is organized into several sections:

- File:** A menu bar at the top.
- PLC:** A section with an  Enable checkbox.
- Pulse Generator:** A vertical list of buttons labeled Method01 through Method07.
- External Trigger:** A vertical list of buttons labeled Method08 through Method13.
- Arm Control:** A vertical list of buttons labeled Method14 through Method16.
- Advanced:** A vertical list of buttons labeled Custom01 through Custom03.

The main control area contains a timing diagram and a configuration panel:

- Timing Diagram:** Shows the sequence of events: an input signal pulse, followed by an integration pulse (Output Signal 1) with a defined pulse width, an exposure time interval, and a VD pulse (Output Signal 2) with a defined VD pulse width. Below the diagram, a camera frame is shown as 'frame delivered' and a frame grabber frame as 'frame acquired'.
- Description:** This method produces an integration pulse on one output followed by a VD pulse on another output. The time interval between the start of the two pulses represents the exposure time.
- Configuration Panel:** Includes fields for:
  - Input signal: Input1
  - Output signal 1: CC1
  - Exposure time: 100 mSec
  - Input polarity: High
  - Output 1 polarity: High
  - Integration pulse: 75 mSec
  - Input DeGlitch: Off
  - Output signal 2: CC2
  - VD pulse width: 25 mSec
  - Input delay: 0
  - Output 2 polarity: Low

**Figure C.13 – PLC Method #13**

## Method #14

Method #14 programs the PLC to wait for the receipt of an external trigger signal and then to “arm” the frame grabber’s capture engine to acquire a single frame. The external trigger signal is received via a GPIO IN[4:1] input, is stretched by a programmable amount of time and then routed to a GPIO OUT[4:1] or CL CC[4:1] output. A debounce or deglitch filter can be applied to the input signal.

The screenshot displays the 'PLC Control' software interface. On the left sidebar, the 'Method' list is expanded to show 'Method14' under the 'Arm Control' section. The main window features a timing diagram with four horizontal tracks: 'Input Signal', 'Output Signal (reset/integration pulse)', 'camera', and 'frame grabber'. The 'Input Signal' track shows a single pulse. The 'Output Signal' track shows a pulse that starts at the beginning of the input pulse and extends for a duration labeled 'exposure time'. The 'camera' track shows a sequence of frames: two 'frame delivered' blocks, a 'partial frame' block, and four more 'frame delivered' blocks. The 'frame grabber' track shows a single 'frame acquired' block that begins at the start of the 'exposure time' pulse. Below the diagram is a 'Description' box containing the text: 'This method produces a synchronous reset/integration pulse to the camera. The start of the pulse is controlled by an external input. The frame grabber will ignore all frames delivered by the camera except for the one following the external input. The frame grabber will be arm'ed to acquire the start of the first frame delivered after the external input is present.' At the bottom, configuration parameters are set: 'Input signal' is 'Input1', 'Output signal' is 'CC1', 'Exposure time' is '15 mSec', 'Input polarity' is 'High', 'Output polarity' is 'High', 'Input DeGlitch' is 'Off', and 'Input delay' is '0'.

**Figure C.14 – PLC Method #14**



## Method #15

Method #15 programs the PLC to wait for the receipt of an external trigger signal and then to “arm” the frame grabber’s capture engine to acquire a programmable number of frames. The external trigger signal is received via a GPIO IN[4:1] input. A debounce or deglitch filter can be applied to the input signal.

The screenshot displays the 'PLC Control' software window. On the left, a sidebar lists various methods under categories: 'PLC' (with an 'Enable' checkbox), 'Pulse Generator' (Methods 01-07), 'External Trigger' (Methods 08-13), 'Arm Control' (Methods 14-16), and 'Advanced' (Custom01-03). Method #15 is selected and highlighted in blue. The main window area shows a timing diagram with three horizontal lines: 'Input Signal', 'camera', and 'frame grabber'. The 'Input Signal' line shows a single high pulse. The 'camera' line shows a sequence of seven 'frame delivered' boxes. The 'frame grabber' line shows three 'frame acquired' boxes, which begin after the external trigger pulse and end after the third 'frame delivered' box. Below the diagram, a 'Description' box explains that the method ignores frames until a pre-defined number (set to 3) are received after the trigger. Configuration fields include: 'Input signal' (dropdown: Input1), 'Frame count' (input: 3), 'Input polarity' (dropdown: High), 'Input DeGlitch' (dropdown: Off), and 'Input delay' (input: 0).

**Figure C.15 – PLC Method #15**

## Method #16

Method #16 programs the PLC to wait for the receipt of an external trigger signal and then to “arm” the frame grabber’s capture engine to acquire frames. The frame acquisition is started/stopped by the presence/absence of an external trigger via a GPIO IN[4:1] input. A debounce or deglitch filter can be applied to the input signal.

The screenshot displays the 'PLC Control' software window. On the left sidebar, the 'Pulse Generator' section is active, with 'Method07' selected. The main area shows a timing diagram with three horizontal axes: 'Input Signal', 'camera', and 'frame grabber'. The 'Input Signal' shows a pulse that occurs after the first three 'frame delivered' events from the 'camera'. The 'frame grabber' shows three 'frame acquired' events corresponding to the fourth, fifth, and sixth 'frame delivered' events from the camera, which occur during the high state of the input signal. Below the diagram, the 'Description' for Method #16 reads: 'This method instructs the frame grabber to ignore all frames delivered by the camera except for the frames that are enveloped by an external input. The frame grabber will be armed to acquire the start of the first frame delivered after the external input is present. It will continue to acquire frames until the external input is negated.' Configuration options include: 'Input signal: Input1', 'Input polarity: High', 'Input DeGlitch: Off', and 'Input delay: 0'.

**Figure C.16 – PLC Method #16**

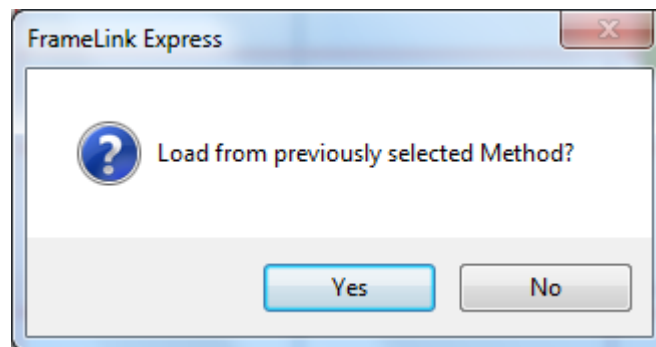
## Custom Methods

---

The custom methods allow users to program the PLC directly by providing access to each of its functional blocks. The ability to create three custom methods is provided. After creation, the custom methods can be saved for later use. Creating a custom method requires configuring the following PLC functional blocks:

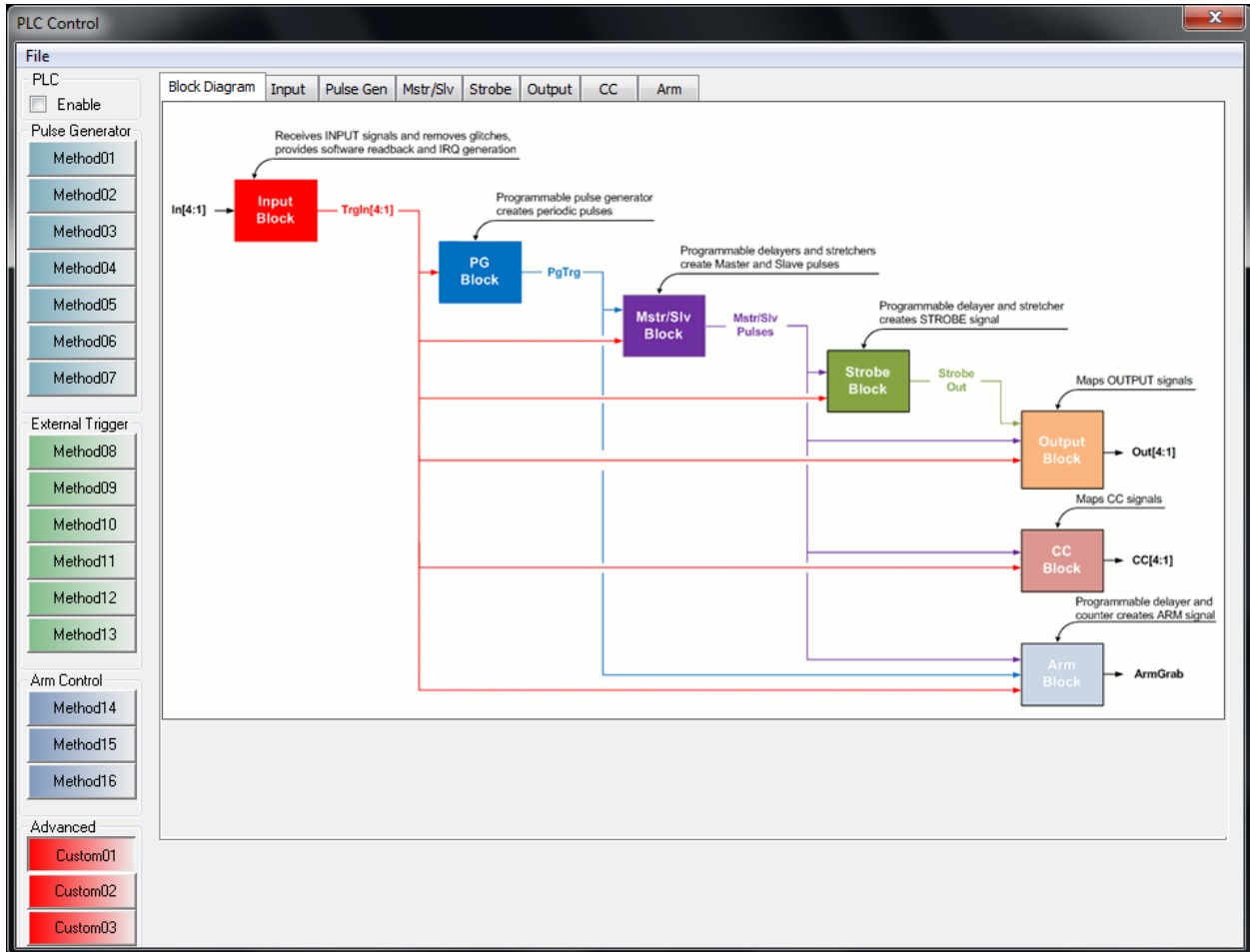
|                       |   |
|-----------------------|---|
| <b>Block Diagram</b>  | Illustrates the PLC's functional blocks and their interconnect.                                   |
| <b>Input Block</b>    | Configures the polarity and filtering of the GPIO IN[4:1] inputs.                                 |
| <b>PG Block</b>       | Configures the Pulse Generator function.  |
| <b>Mstr/Slv Block</b> | Configures the generation of the Master and Slave pulses.   |
| <b>Strobe Block</b>   | Configures the generation of the STROBE output signal.  |
| <b>Output Block</b>   | Configures the generation of the GPIO OUT[4:1] output signals.                                    |
| <b>CC Block</b>       | Configures the generation of the CL CC[4:1] output signals.                                       |
| <b>Arm Block</b>      | Configures the generation of the ARM signal to be used by the frame grabber's acquisition engine. |

Selecting any of the custom methods results in the following pop-up message. Clicking on **Yes** causes the PLC functional blocks to be preloaded with the contents of the previously selected method.



# Block Diagram

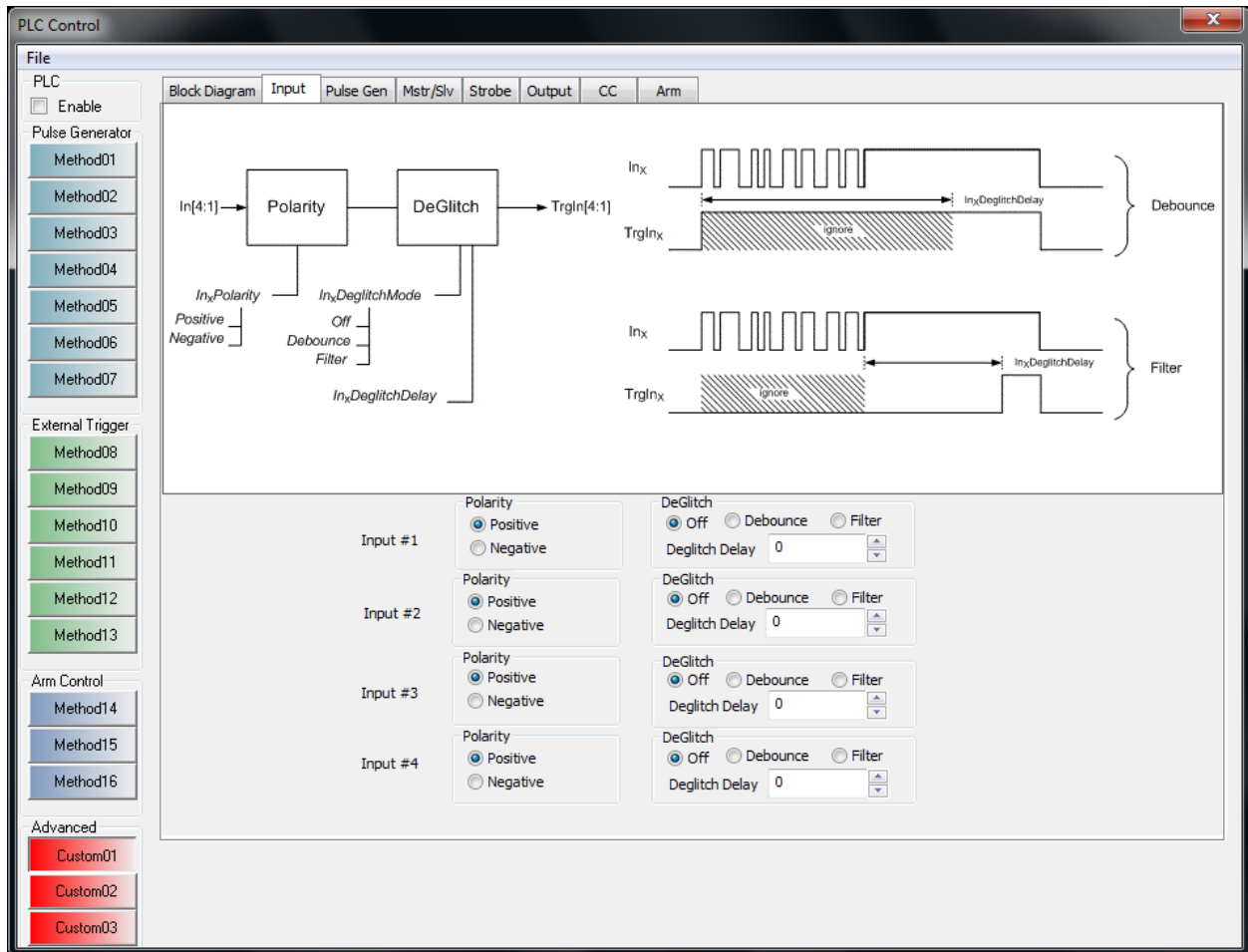
The Block Diagram dialog illustrates the PLC's functional blocks and their interconnect. It is used for illustrative purposes only.



**Figure C.17 – PLC Block Diagram**

# Input

The Input dialog allows the user to select the polarity of the GPIO IN[4:1] input signals and to apply a debounce or deglitch filter.



**Figure C.18 – PLC Input block**

**Polarity** Selects the polarity of the GPIO IN[4:1] input signal. Selecting **Negative** will invert the signal.

**DeGlitch** Selects the mode of operation of the deglitch circuit.

**Off** Turns off the deglitch circuit. Deglitch is not required if the input signal is stable. Deglitch is required if the input signal contains any spurious glitches ( i.e. contact bounce in a mechanical switch ).

**Debounce** This selection will cause the trigger to immediately assert with the active edge of the input signal. Any subsequent edges in the input signal will be ignored for a period of time set by the **DeglitchDelay**.

**Filter** This selection will cause the trigger to be asserted only after the input signal has been stable for a period of time set by the **DeglitchDelay**.

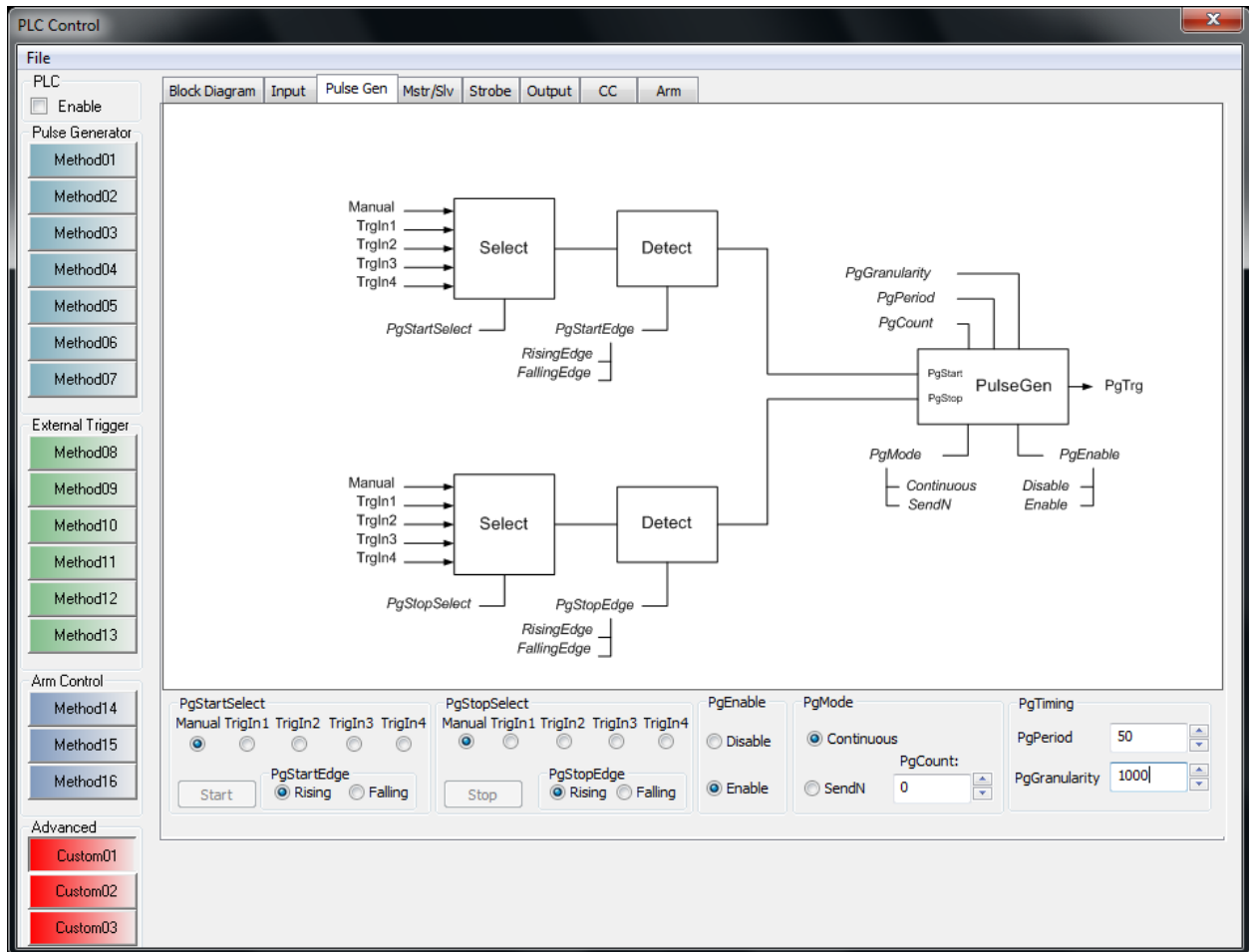
**Deglitch  
Delay**

In **Debounce** mode: Determines the amount of the time that the input signal is ignored.

In **Filter** mode: Determines the amount of time that the input signal has to be stable and glitch-free.

## Pulse Gen

The Pulse Gen dialog allows the user to configure the pulse generator using the following parameters:



**Figure C.19 – PLC Pulse Generator block**

**PgStartSelect** Selects the source signal that will start the pulse generator. If **Manual** is selected, then the **Start** button is used. **TrgIn[4:1]** refers to the trigger signals generated by the Input block.

**PgStartEdge** Selects the active edge of the start source as either **Rising** or **Falling**.

**PgStopSelect** Selects the source signal that will stop the pulse generator. If **Manual** is selected, then the **Stop** button is used. **TrgIn[4:1]** refers to the trigger signals generated by the Input block.

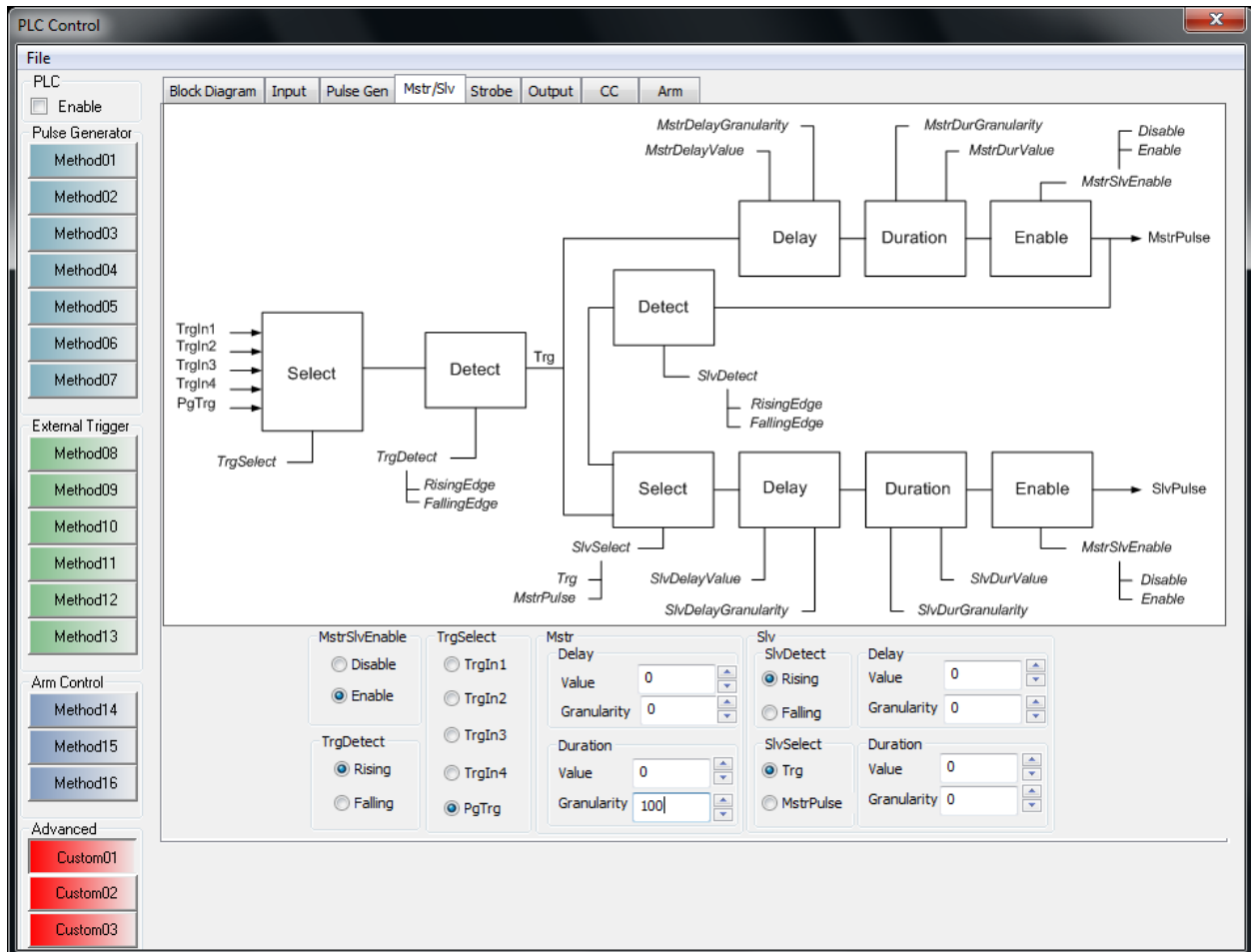
|                      |   |
|----------------------|---|
| <b>PgStopEdge</b>    | Selects the active edge of the stop source as either <b>Rising</b> or <b>Falling</b> .  |
| <b>PgEnable</b>      | Enables/disables the operation of the Pulse Generator.  |
| <b>PgMode</b>        | Selects the mode of operation of the Pulse Generator.   |
| <b>Continuous</b>    | The Pulse Generator will provide a continuous train of pulses.  |
| <b>SendN</b>         | The Pulse Generator will only provide N pulses and then automatically stop. The value N is set in the <b>PgCount</b> field.   |
| <b>PgCount</b>       | Determines the number of pulses to produce when <b>PgMode</b> = <b>SendN</b> .  |
| <b>PgPeriod</b>      | Determines the period of the pulses produced by the Pulse Generator. The units/increment of the period is determined by the <b>PgGranularity</b> field.   |
| <b>PgGranularity</b> | Determines the clock multiplication factor to be used for the <b>PgPeriod</b> field. The reference clock is 100 MHz, so a <b>PgGranularity</b> of 1 results in the <b>PgPeriod</b> to be in units of 10 nSeconds. |

For example: if **PgGranularity** is set to 10 and **PgPeriod** is set to 5, then the Pulse Generator will produce a signal with a period of 500 nSeconds.



## Mstr/Slv

The Mstr/Slv dialog allows the user to configure a set of Master and Slave pulses using the following parameters:



**Figure C.20 – PLC Master/Slave block**

**MstrSlvEnable** Enables/disables the generation of the Master and Slave pulses.

**TrgSelect** Selects the source signal that will be used to generate the Master and Slave pulses. **TrgIn[4:1]** refers to the trigger signals generated by the Input block. **PgTrg** refers to the trigger signals generated by the PG block.

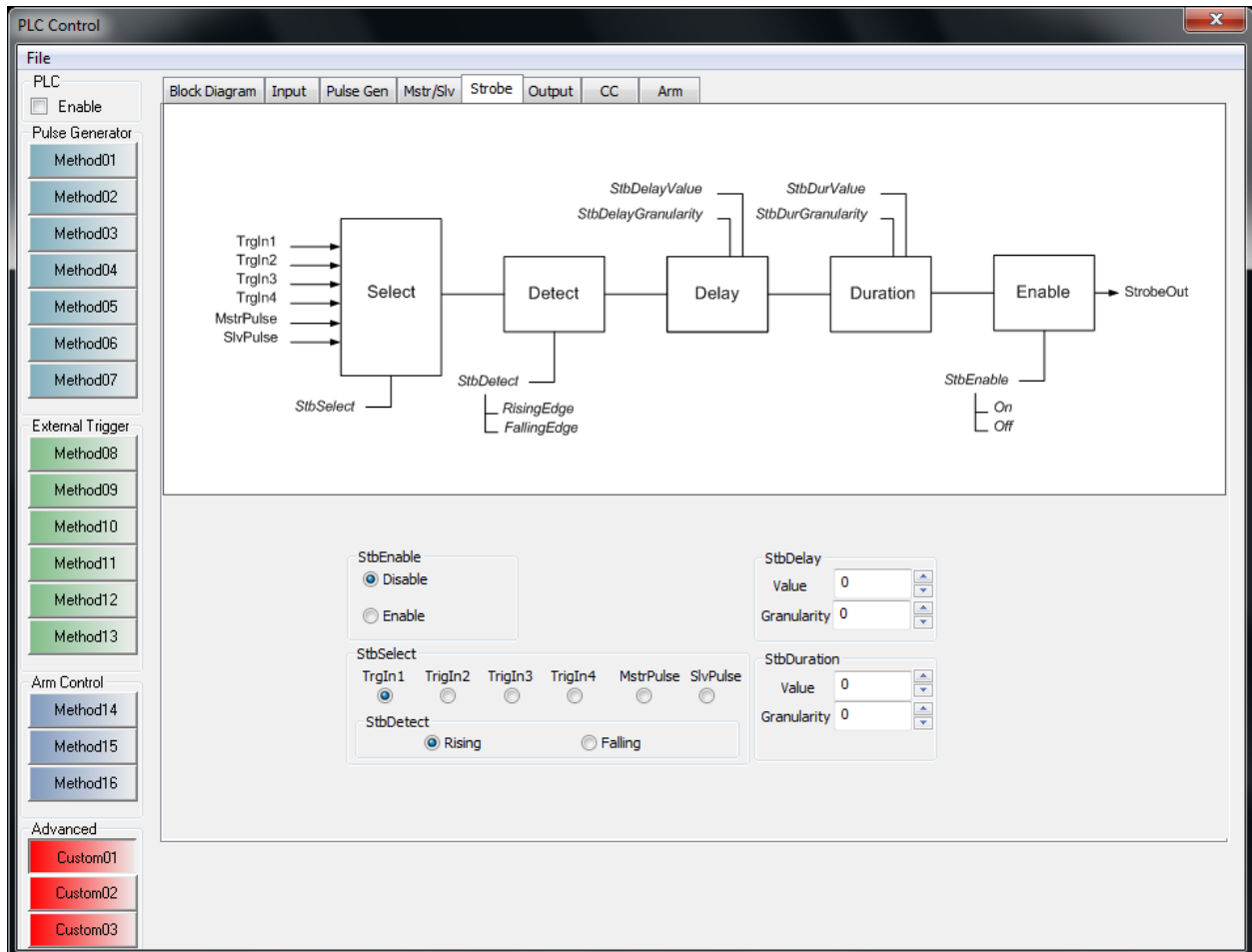
**TrgDetect** Selects the active edge of the selected source signal as either **Rising** or **Falling**.

|                      |   |
|----------------------|---|
| Mstr                 | These parameters control the generation of the Master pulse.  |
| Delay Value          | Determines how much the Master pulse will be delayed from the selected source signal. The units/increment of the delay is determined by the <b>DelayGranularity</b> field.  |
| Delay Granularity    | Determines the clock multiplication factor to be used for the <b>DelayValue</b> field. The reference clock is 100 MHz, so a <b>DelayGranularity</b> of 1 results in the <b>DelayValue</b> to be in units of 10 nSeconds.          |
| Duration Value       | Determines the width of the generated Master pulse. The units/increment of the duration is determined by the <b>DurationGranularity</b> field.  |
| Duration Granularity | Determines the clock multiplication factor to be used for the <b>DurationValue</b> field. The reference clock is 100 MHz, so a <b>DurationGranularity</b> of 1 results in the <b>DurationValue</b> to be in units of 10 nSeconds. |
| Slv                  | These parameters control the generation of the Slave pulse.   |
| Slv Detect           | Selects the active edge of the Master pulse, as either <b>Rising</b> or <b>Falling</b> , to be used to drive the creation of the Slave pulse.   |
| Slv Select           | Selects the source signal that will be used to generate the Slave pulse. Either the Master pulse or the results of the TrgDetect block can be used as the source of the Slave pulse.  |
| Delay Value          | Determines how much the Slave pulse will be delayed from the selected source signal. The units/increment of the delay is determined by the <b>DelayGranularity</b> field.   |
| Delay Granularity    | Determines the clock multiplication factor to be used for the <b>DelayValue</b> field. The reference clock is 100 MHz, so a <b>DelayGranularity</b> of 1 results in the <b>DelayValue</b> to be in units of 10 nSeconds.          |
| Duration Value       | Determines the width of the generated Slave pulse. The units/increment of the duration is determined by the <b>DurationGranularity</b> field.   |
| Duration Granularity | Determines the clock multiplication factor to be used for the <b>DurationValue</b> field. The reference clock is 100 MHz, so a  |

**DurationGranularity** of 1 results in the **DurationValue** to be in units of 10 nSeconds.

## Strobe

The Strobe dialog allows the user to configure the generation of a Strobe pulse. The Strobe pulse can then be routed to a GPIO OUT[4:1] output signal.



**Figure C.21 – PLC Strobe block**

**StbEnable**

Enables/disables the generation of the Strobe pulse.

**StbSelect**

Selects the source signal that will be used to generate the Strobe pulse. **TrgIn[4:1]** refers to the trigger signals generated by the Input block. **MstrPulse** and **SlvPulse** refers to the pulses generated by the Mstr/Slv block.

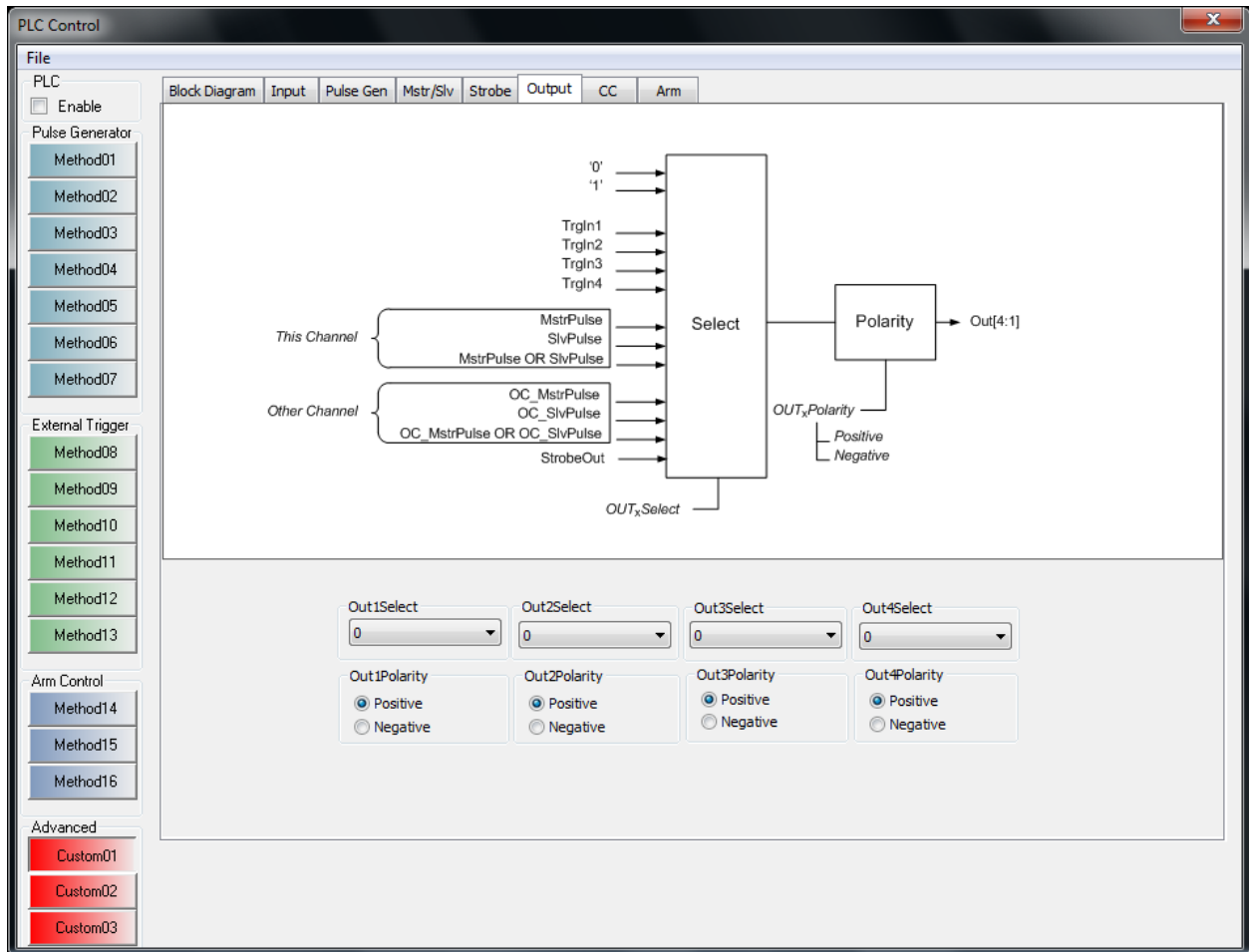
**StbDetect**

Selects the active edge of the selected source signal as either **Rising** or **Falling**.

|                         |  |
|-------------------------|--|
| StbDelay Value          | Determines how much the Strobe pulse will be delayed from the selected source signal. The units/increment of the delay is determined by the <b>StbDelayGranularity</b> field.  |
| StbDelay Granularity    | Determines the clock multiplication factor to be used for the <b>StbDelayValue</b> field. The reference clock is 100 MHz, so a <b>StbDelayGranularity</b> of 1 results in the <b>StbDelayValue</b> to be in units of 10 nSeconds.          |
| StbDuration Value       | Determines the width of the generated Strobe pulse. The units/increment of the duration is determined by the <b>StbDurationGranularity</b> field.  |
| StbDuration Granularity | Determines the clock multiplication factor to be used for the <b>StbDurationValue</b> field. The reference clock is 100 MHz, so a <b>StbDurationGranularity</b> of 1 results in the <b>StbDurationValue</b> to be in units of 10 nSeconds. |

# Output

The Output dialog allows the user to select the source and polarity of the GPIO OUT[4:1] output signals.



**Figure C.22 – PLC Output block**

## Out<sub>x</sub>Select

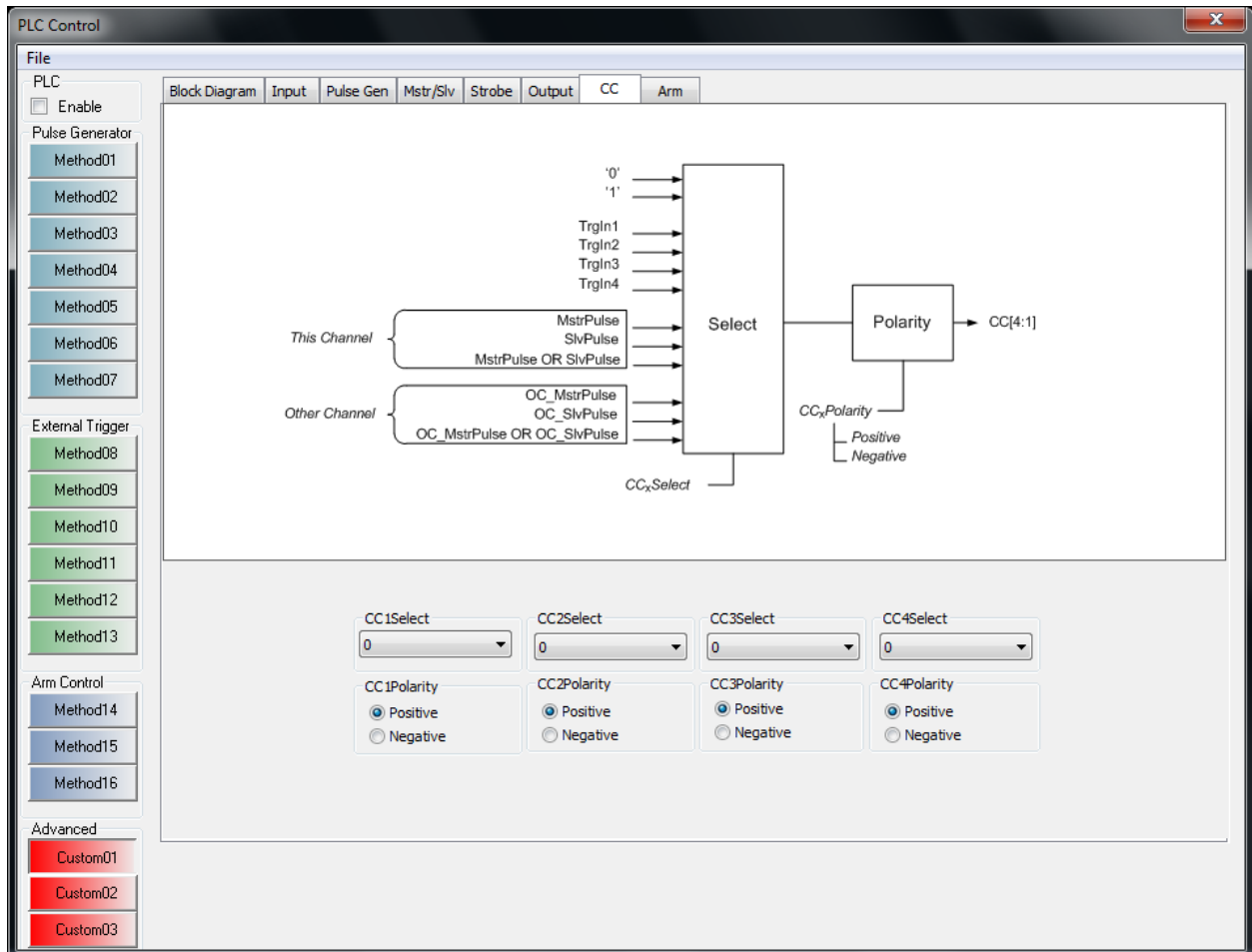
Selects the source signal that will be routed to the OUT signal. **TrglIn[4:1]** refers to the trigger signals generated by the Input block. **MstrPulse** and **SlvPulse** refers to the pulses generated by the Mstr/Slv block. “This Channel” refers to pulses created by the PLC attached to the current channel, while “Other Channel” refers to pulses created by the other channel’s PLC. **StrobeOut** refers to the pulse created by the Strobe block.

## Out<sub>x</sub>Polarity

Selects the polarity of the output signal. Selecting **Negative** will invert the selected source signal.

## CC

The CC dialog allows the user to select the source and polarity of the Camera Link CC[4:1] output signals.



**Figure C.22 – PLC CC block**

### CC<sub>x</sub>Select

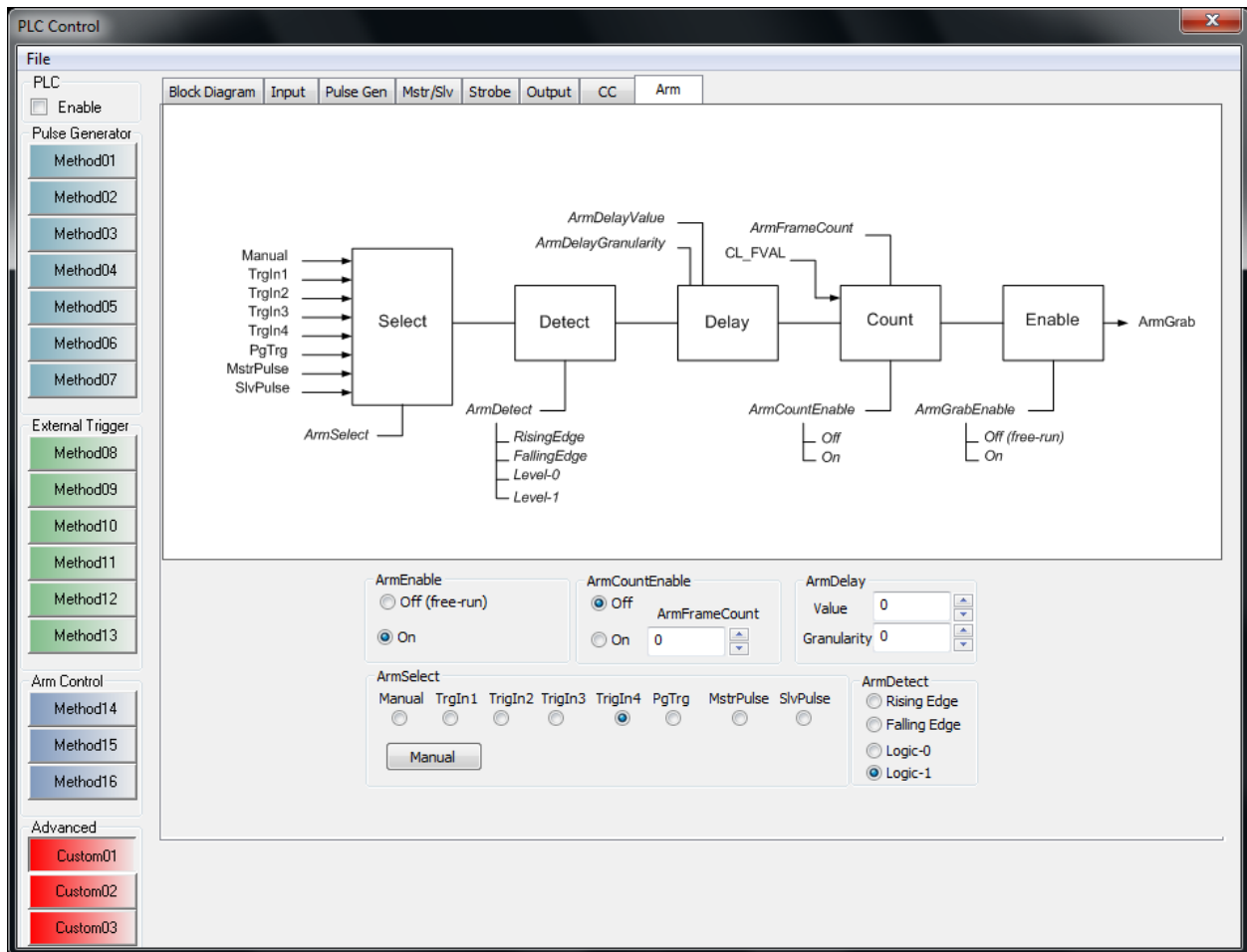
Selects the source signal that will be routed to the Camera Link CC signal. **TrgIn[4:1]** refers to the trigger signals generated by the Input block. **MstrPulse** and **SlvPulse** refers to the pulses generated by the Mstr/Slv block. “This Channel” refers to pulses created by the PLC attached to the current channel, while “Other Channel” refers to pulses created by the other channel’s PLC. This is useful when you want to have one channel’s PLC drive the CC signals on both Camera Link channels ( i.e. to synchronize two cameras ).

### CC<sub>x</sub>Polarity

Selects the polarity of the CC signal. Selecting **Negative** will invert the selected source signal.

# Arm

The Arm dialog allows the user to configure the generation of an ArmGrab signal. The ArmGrab signal is used by the grabber's capture engine to qualify the acquisition of frames. The capture engine will acquire frames, from the Camera Link interface, as long as the ArmGrab signal is asserted.



**Figure C.23 – PLC ARM block**

## ArmEnable

Enables/disables the operation of the 'arm' function. Selecting **Off** returns the grabber into the free-running mode.

## ArmSelect

Selects the source signal that will be used to generate the ArmGrab signal. If **Manual** is selected, then the **Manual** button is used. **TrgIn[4:1]** refers to the trigger signals generated by the Input block. **PgTrg** refers to the trigger signal generated by the PG block. **MstrPulse** and **SlvPulse** refers to the pulses generated by the Mstr/Slv block.



|                      |   |
|----------------------|---|
| ArmDetect            | Selects the active edge of the selected source signal as either <b>Rising</b> or <b>Falling</b> .   |
| ArmDelay Value       | Determines how much the ArmGrab signal will be delayed from the selected source signal. The units/increment of the delay is determined by the <b>ArmDelayGranularity</b> field.   |
| ArmDelay Granularity | Determines the clock multiplication factor to be used for the <b>ArmDelayValue</b> field. The reference clock is 100 MHz, so a <b>ArmDelayGranularity</b> of 1 results in the <b>ArmDelayValue</b> to be in units of 10 nSeconds. |
| ArmCount Enable      | If set to <b>On</b> , causes the ArmGrab signal to be active for a limited number of frames as determined by the <b>ArmFrameCount</b> field.  |
| ArmFrame Count       | Determines the number of frames that the ArmGrabsignal will be active for when <b>ArmCountEnable = On</b> .   |

# Appendix

## D

## Power Over CameraLink (PoCL)

This appendix applies to the VCE-CLPCIe02 card only and provides a reference on how to use the PoCL functionality provided by the FrameLink Express.

### Overview

The FrameLink Express design is fully compliant with the Power Over Camera Link standard as specified in Annex E of the Camera Link specification version 1.2.

Power Over Camera Link describes an extension to the Camera Link standard to allow a camera to be powered by the frame grabber via the Camera Link cable. This allows a single cable solution to provide power and data, useful in low cost applications. Power is supplied to the camera by redefining the four “Inner Shield” wires in a Camera Link cable as two power lines and two power returns. This means that PoCL continues to use the existing Camera Link connectors, allowing backwards compatibility with existing equipment. All existing signals and functions available to a conventional (non-PoCL) system are still available in a PoCL system. The FrameLink Express implements the SafePower protocol to protect systems in the event of an accidental mix of PoCL and conventional Camera Link products.

### Compatibility

The FrameLink Express is considered a “Switchable PoCL frame grabber”, where the 12V can be switched to ground to allow the frame grabber to operate with both PoCL and conventional Camera Link cameras, as opposed to a “Dedicated PoCL frame grabber” which is dedicated to PoCL operation and therefore always supplies 12V.

### Voltage

The FrameLink Express supplies 12V DC  $\pm 1V$  to pins and 1 and 26 on the Camera Link connector.

### Power

The FrameLink Express is capable of supplying 4W over the full voltage. The FrameLink Express ties together pin 1 to pin 26, and pin 13 to pin 14, on the Camera Link connector.

*Comment: This helps ensure that the power is equally split between the four power lines in the cable.*

## Over-Current Protection

In the event of a conventional Camera Link cable or camera being plugged into a PoCL frame grabber, the power output from the frame grabber would get shorted to ground. Therefore, the FrameLink Express implements an over-current protection circuit to limit the transient power in the event of a power-ground short.

## SafePower

SafePower is a protocol to prevent the frame grabber from attempting to supply power to a conventional cable or camera.

The FrameLink Express meets the following SafePower requirements:

- It senses that a PoCL camera and cable are connected before applying power. It can do this by sensing the camera's nominal  $10\text{k}\Omega$  input resistance "Rs", in which case it shall use a sense current of  $52\mu\text{A} \pm 10\%$ .

*Comment: The  $10\text{k}\Omega / 52\mu\text{A}$  combination, with a total tolerance of 15%, gives a sensed voltage of 0.44V to 0.6V after allowing for the RC time constant of 0.57s from the  $57\mu\text{F}$  maximum capacitance "Cs" with the  $10\text{k}\Omega$  input resistance. Note that if a conventional camera or cable is connected, the sensed voltage will be near zero.*

- Once power has been applied to a PoCL camera, the FrameLink Express monitors the Camera Link XCLK clock pair. If the clock is not present within a specified time of the frame grabber supplying power, or if at any time the clock stops for more than a specified time, the frame grabber shall remove power from the camera.

*Comment: This causes power to be removed if the camera or cable is unplugged, and prevents the risk of a short should a user unplug a powered PoCL camera, and plug in a conventional camera in its place. It also allows the state machine controlling SafePower to return to its "Sense" state ready to detect a new camera.*

- Once power has been applied to a PoCL camera, the FrameLink Express monitors the voltage on pins 1 and 26 on the Camera Link connector. If this voltage drops to a level for more than 20ms indicating that the OCP has tripped, the frame grabber shall remove power from the camera.
- If the FrameLink Express senses that a conventional Camera Link camera or cable is connected, it shall connect its PoCL power lines to ground.

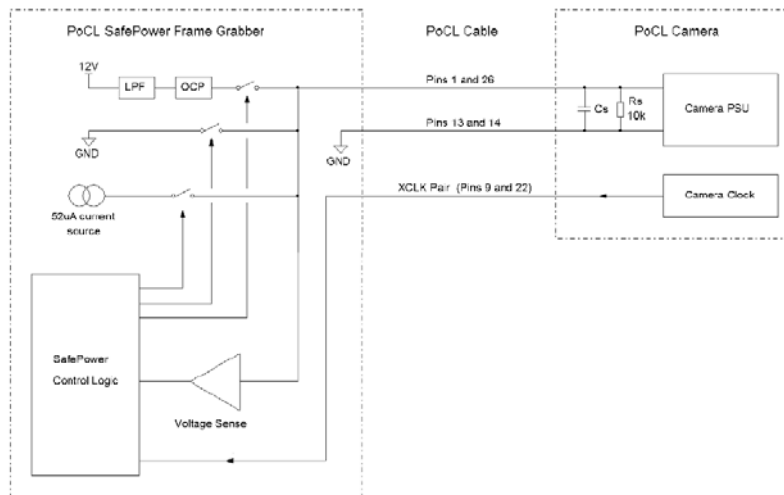
*Comment: This allows them to operate as inner shield wires.*

- Once the PoCL power lines have been connected to ground for a conventional camera, the FrameLink Express monitors the Camera Link XCLK clock pair. If the clock is not present within a specified time of the frame grabber supplying power, or if at any time the clock stops for more than 1s, the frame grabber shall disconnect the PoCL power lines from ground.

*Comment: This allows the state machine controlling SafePower to return to its “Sense” state ready to detect a new camera.*

## Disable Mode

The FrameLink Express allows the user to place the card into a “PoCL Disable” mode where its PoCL power lines are always connected to ground. This allows for legacy conventional cameras with very long clock startup or clock disconnection times, in case any operational problems result from the action of the PoCL sense circuit.



**Figure D.1 – PoCL Block Diagram**

### Notes:

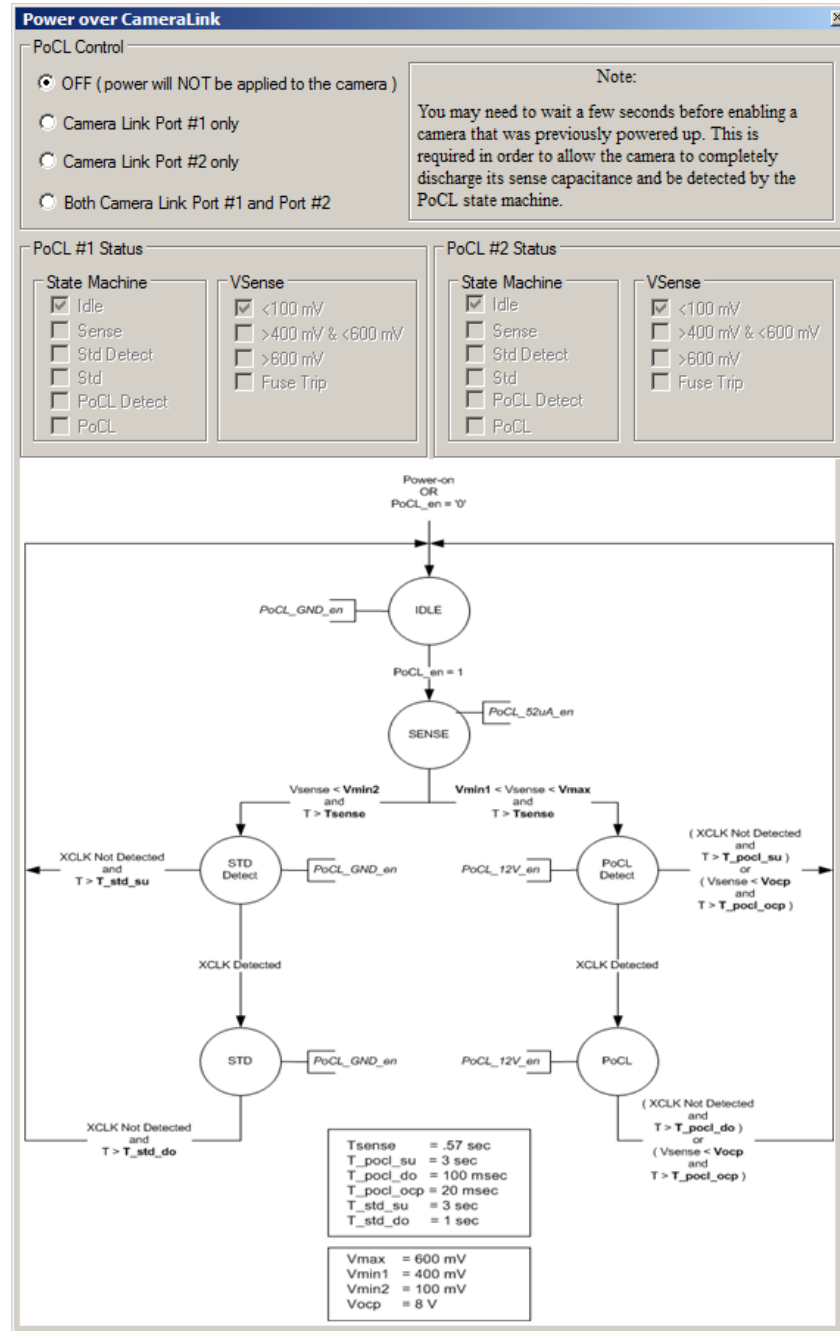
- LPF = Power supply low pass filter.
- OCP = Over current protection circuit.
- PSU = Power supply unit.
- SafePower Control Logic = SafePower protection protocol.
- Rs = Camera sense resistor for SafePower.
- Cs = Camera input capacitance for SafePower.

## LEDs

Two LED indicators are provided, one per channel, on the IO bracket to indicate that the FrameLink Express is supplying power to the camera.

## PoCL Dialog

The PoCL dialog allows the user to enable PoCL operation. It also provides status which reflects the current state of the PoCL State Machine as well as the VSense ( voltage sensing ) circuitry. Support for both Camera Link ports ( i.e. connectors ) is provided.



**Figure D.2 – PoCL Safe Power state machine**

## PoCL Control

|         |  |
|---------|--|
| Off     | Turns off both PoCL state machines. Power will not be applied to the camera. Use this for cameras that are <u>not</u> PoCL compliant.  |
| Port #1 | Turns on the state machine for Camera Link connector #1 only.  |
| Port #2 | Turns on the state machine for Camera Link connector #2 only.  |
| Both    | Turns on the state machine for both Camera Link port #1 and port #2 simultaneously. This is required when connecting to a PoCL compliant camera that expects power from both camera link connectors. |

## PoCL Status

|               |  |
|---------------|--|
| State Machine | Displays the current state of the PoCL state machine. Refer to the state diagram for more information.                 |
| VSense        | Displays the voltages measured by the PoCL voltage sensing circuitry. Refer to the state diagram for more information. |

# Appendix

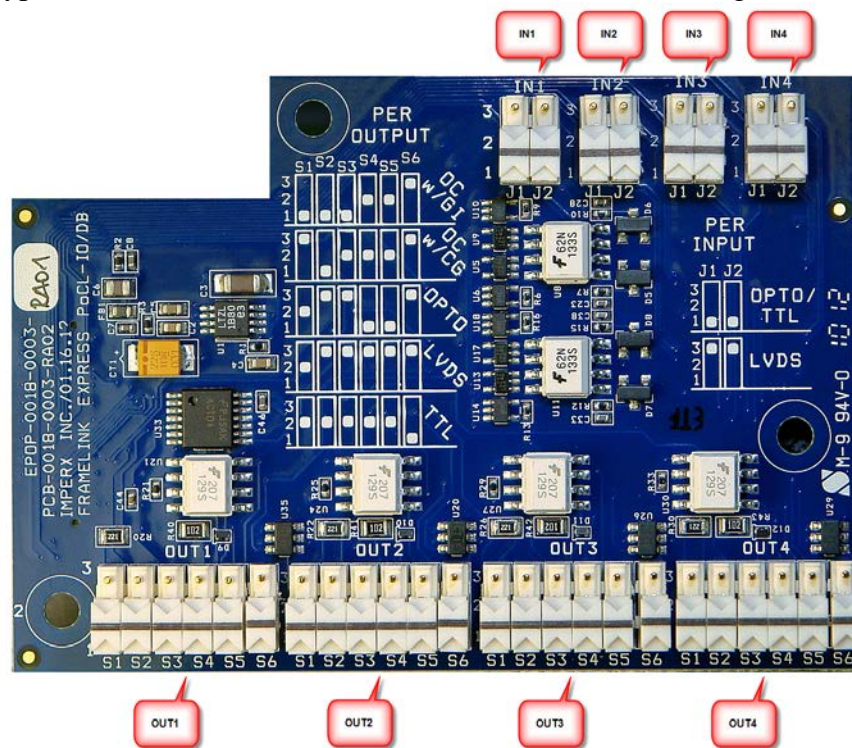
# E

## General Purpose Input/Output

This appendix applies to the VCE-CLPCIE02 card only and provides a reference on how to use the GPIO functionality provided by the FrameLink Express.

### Overview

The FrameLink Express design includes an I/O capability which supports four inputs and four outputs. These signals are shared between the two channels and are connected to the PLC of each channel. Each channel's PLC can sink the inputs and source the outputs. The outputs are logical-or'ed between the two channels. Support for a variety of electrical interfaces is provided. Selection of which electrical interface signaling type to use is set via switches on the VCE-CLPCIE02 daughter-card.



**Figure E.1 – VCE-CLPCIE02 Daughter-card GPIO Switches**

## Inputs

The FrameLink Express design supports three input signaling types:

- Opto-coupled
- LVDS
- TTL

Each of the four inputs, IN[4:1], can be independently configured as one of these three signaling types. The configuration is made by setting switches J1 and J2 on the daughter-card.

| <b>Signaling</b> | <b>J1</b> | <b>J2</b> |
|------------------|-----------|-----------|
| Opto-coupled     | 1         | 1         |
| LVDS             | 3         | 3         |
| TTL              | 1         | 1         |

**Table E.1 – GPIO IN[4:1] switch settings**

## Outputs

The FrameLink Express design supports five output signaling types:

- Open-collector with Galvanic Isolation ( OC w/GI )
- Open-collector with Common Ground ( OC w/CG )
- Opto-coupled
- LVDS
- TTL

Each of the four outputs, OUT[4:1], can be independently configured as one of these five signaling types. The configuration is made by setting switches S1 thru S6 on the daughter-card.

| <b>Signaling</b> | <b>S1</b> | <b>S2</b> | <b>S3</b> | <b>S4</b> | <b>S5</b> | <b>S6</b> |
|------------------|-----------|-----------|-----------|-----------|-----------|-----------|
| OC w/GI          | 1         | 1         | 1         | 2         | 2         | 3         |
| OC w/CG          | 3         | 1         | 2         | 2         | 2         | 3         |
| Opto-coupled     | 2         | 3         | 3         | 1         | 1         | 3         |
| LVDS             | 2         | 3         | 3         | 3         | 3         | 3         |
| TTL              | 2         | 2         | 2         | 2         | 2         | 1         |

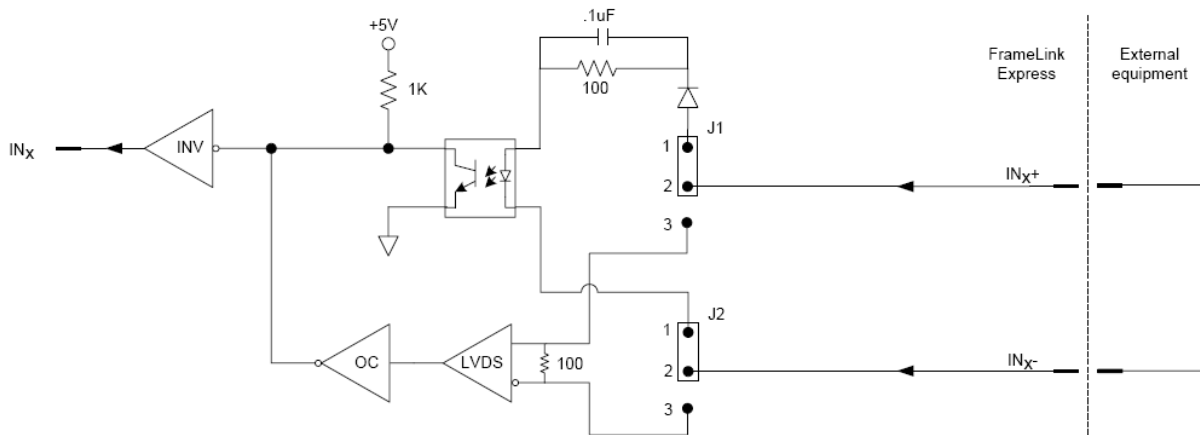
**Table E.2 – GPIO OUT[4:1] switch settings**



## General Purpose Input Circuit

---

The input circuit can be configured, via switches J1 and J2, to accept external sources which provide opto-coupled, LVDS or TTL signaling.

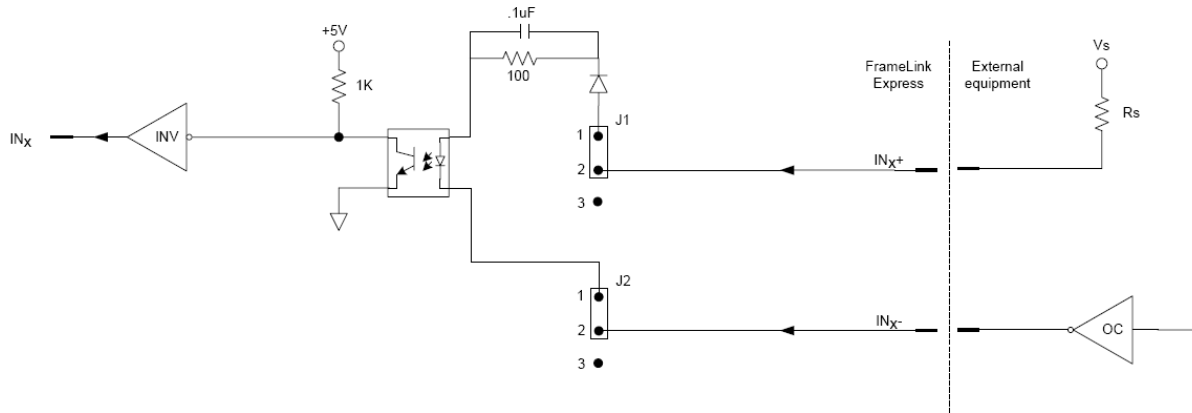


**Figure E.2 – General Purpose Input Circuit**

## Opto-coupled Input Circuit

---

This configuration accepts an external source which is electrically isolated from the FrameLink Express card. The user must supply a current limited LED voltage on the IN+ pin and must sink the LED's current on the IN- pin.

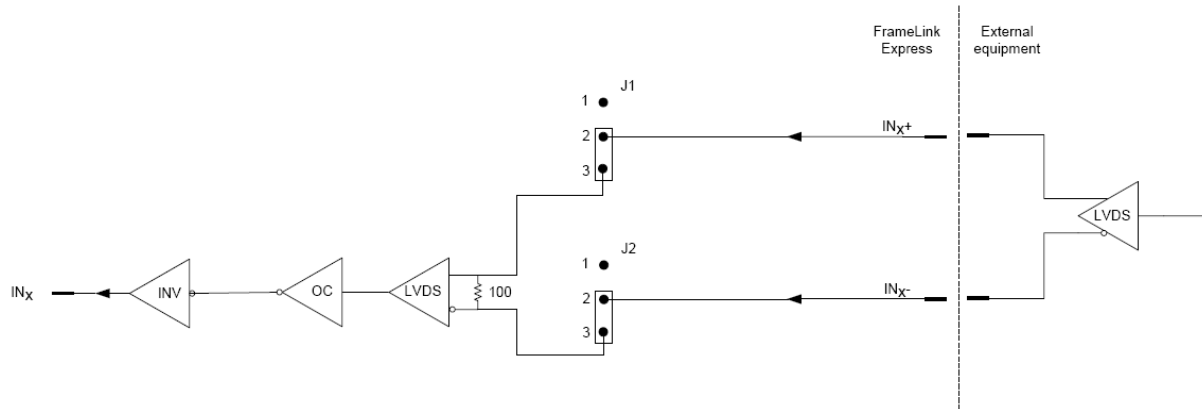


**Figure E.4 – Opto-coupled Input Circuit**

## LVDS Input Circuit

---

This configuration accepts an external source which provides differential LVDS signaling. The FrameLink Express's LVDS receiver is terminated via a 100 Ohm parallel resistor.

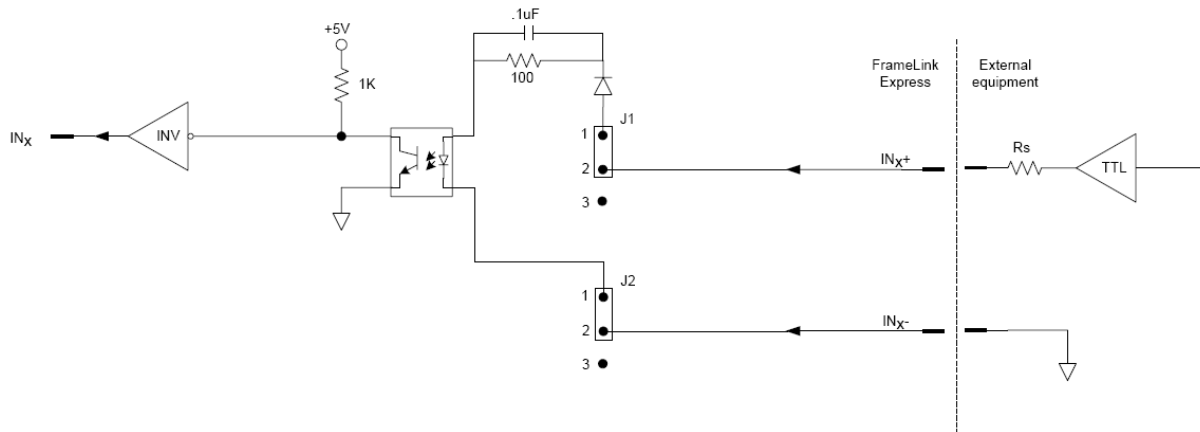


**Figure E.5 – LVDS Input Circuit**

# TTL Input Circuit

---

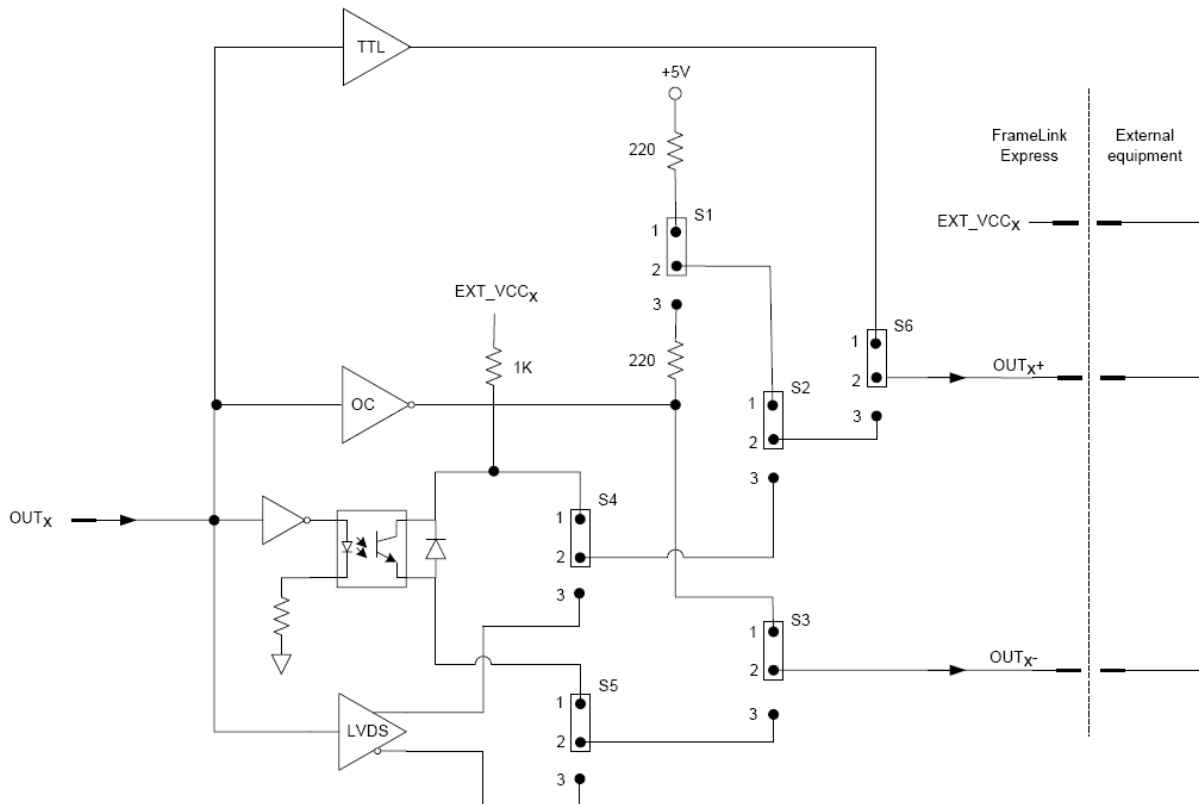
This configuration accepts an external source which provides single ended TTL signaling.



**Figure E.6 – TTL Input Circuit**

## General Purpose Output Circuit

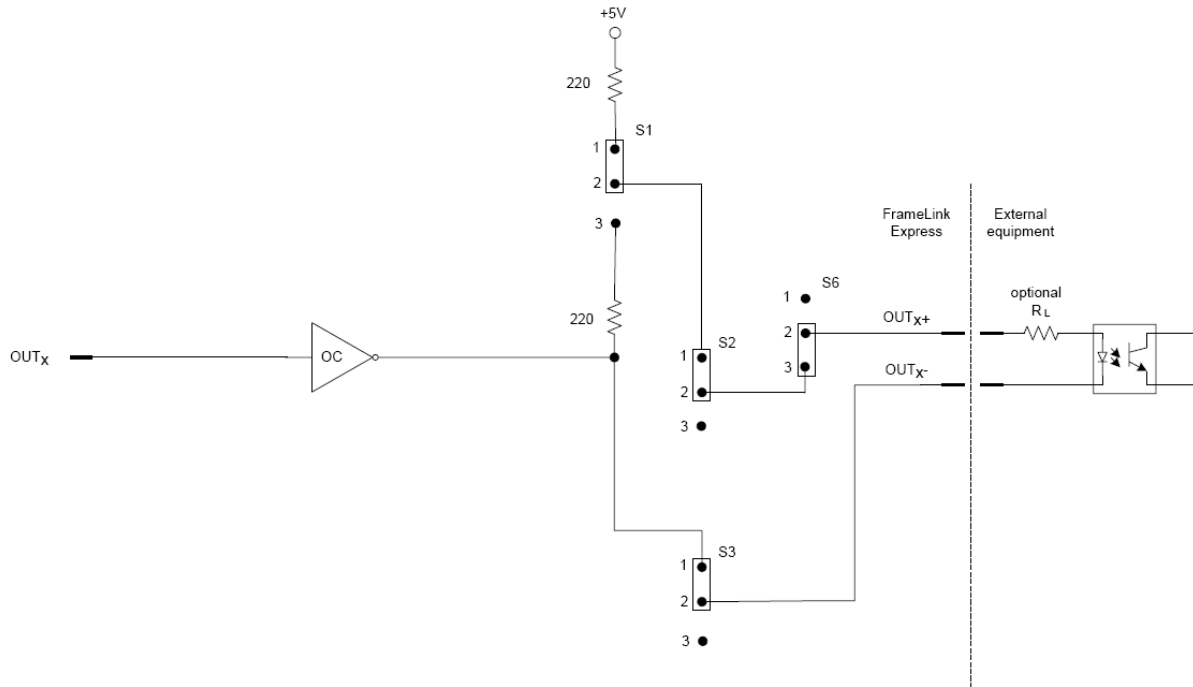
The output circuit can be configured, via switches S1 through S6, to provide open-collector with galvanic isolation, open-collector with common ground, opto-coupled, LVDS or TTL signaling.



**Figure E.3 – General Purpose Output Circuit**

## Open Collector using Galvanic Isolation Output Circuit

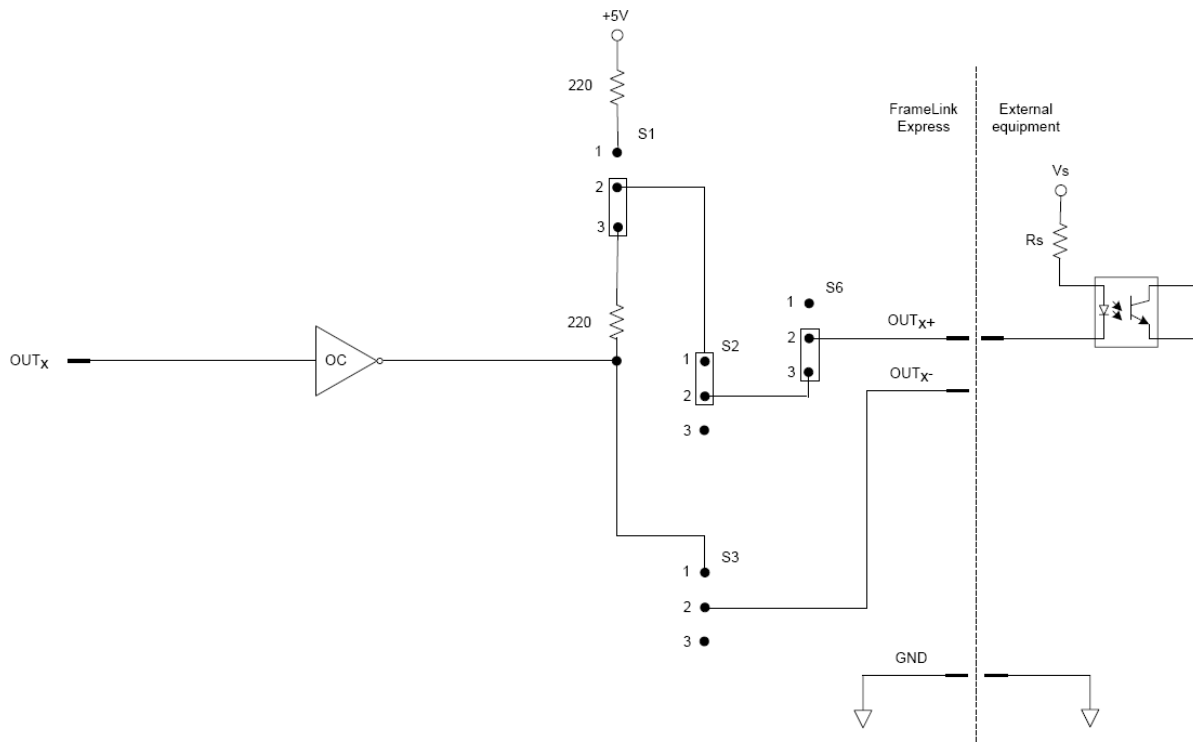
This configuration drives a user's opto-coupled device configured for galvanic isolation between the Framelink Express and the user. The power for the user's LED is supplied by the board's +5V through a 220 Ohm resistor. The open-collector driver will sink the current from the LED.



**Figure E.7 – Open Collector using Galvanic Isolation Output Circuit**

## Open Collector using Common Ground Output Circuit

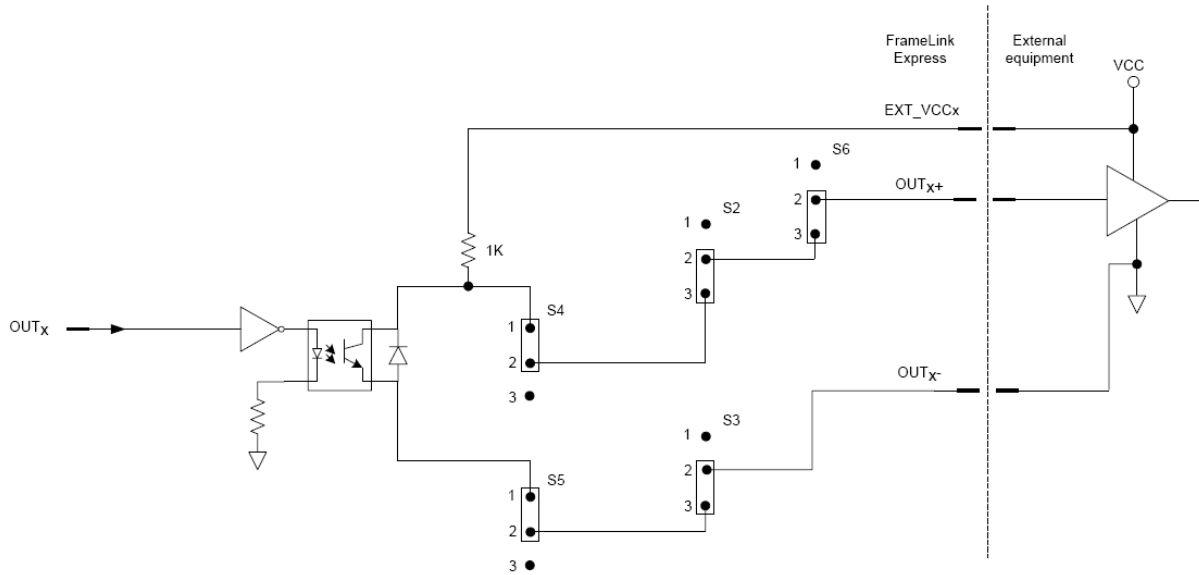
This configuration drives a user's opto-coupled device configured for a common ground between the Framelink Express and the user. The user must supply the +5V for his LED and the two systems must have their grounds connected. The open-collector driver will sink the current from the LED.



**Figure E.8 – Open Collector using Common Ground Output Circuit**

## Opto-Isolated Output Circuit

This configuration drives a user's receiver configured for galvanic isolation between the Framelink Express and the user. The Framelink Express output is opto-coupled and provides an isolated NPN transistor switch. The user must supply the voltage required by his receiver via the EXT\_VCC pin and must also connect the ground required by his receiver to the OUT- pin.



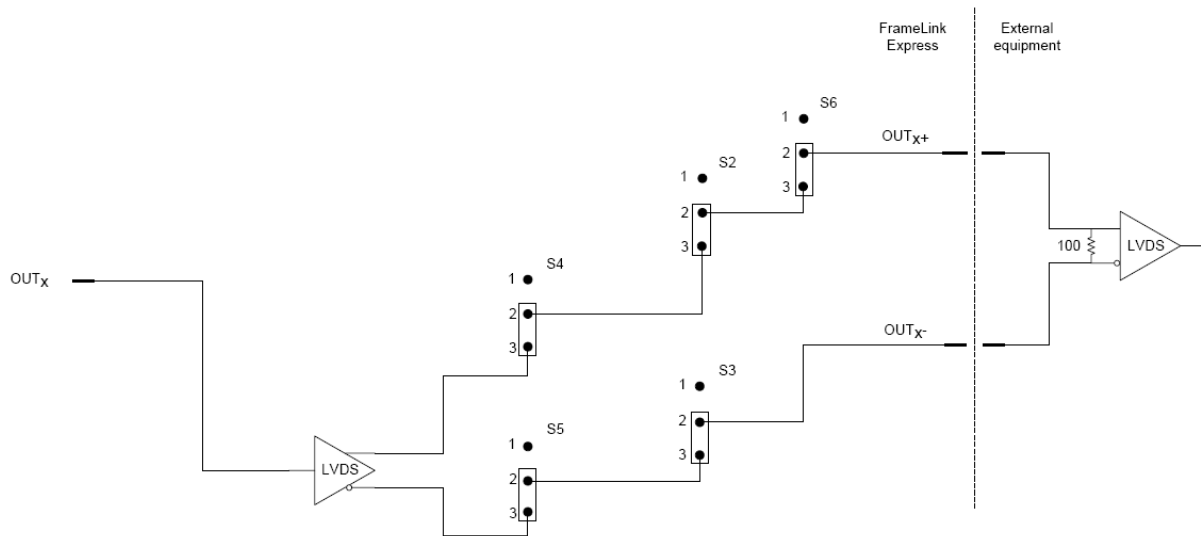
**Figure E.9 – Opto-coupled Output Circuit**



## LVDS Output Circuit

---

This configuration drives a user's differential LVDS receiver. The user's LVDS receiver should be terminated via a 100 Ohm parallel resistor.



**Figure E.10 – LVDS Output Circuit**

## TTL Output Circuit

---

This configuration drives a user's single-ended TTL receiver. The two systems must have their grounds connected.



**Figure E.11 – TTL Output Circuit**

## I/O Electrical Specifications

---

| Input |              |  |
|-------|--------------|--|
|       | Opto-coupled | Input current:<br>logic-0: 250 uA (max)<br>logic-1: 6.3 mA (min) to 15 mA (max)                                  |
|       |              | Input voltage threshold:<br>logic-0: 1.0 V (max)<br>logic-1: 3.5 V (min)   |
|       | LVDS         | 100 ohm differential termination   |
|       |              | Input current: -20 uA (min) to +20 uA (max)  |
|       |              | Input voltage:<br>common mode: -5 V (min) to +5 V (max)<br>differential threshold: -200 mV (min) to 200 mV (max) |
|       | TTL          | Use 330 Ohm series resistor (Rs)   |
|       |              | Input voltage threshold:<br>logic-0: 1.0 V (max)<br>logic-1: 3.5 V (min)   |

**Table E.3 – Input electrical specifications**

| Output |  |  |
|--------|--|--|
|        | Open-collector with galvanic isolation |  |
|        | Open-collector with common ground      | Vout: 30V (max) pull-up  |
|        |  | Vol: 0.7V (max) @ 30mA   |
|        | Opto-coupled                           | ExtVCC: 5V(min), 15V (max)   |
|        |  | Internal Rp: 1.00 KOhm   |
|        |  | Vol: 0.4V (max) @ 2mA  |
|        | LVDS                                   | Output voltage (loaded to 100 ohm):<br>differential: 250 mV (min) to 450 mV (max)<br>common mode: 1.125 V (min) to 1.375 V (max)<br>logic-0: 0.9 V (min)<br>logic-1: 1.6 V (max) |
|        | TTL                                    | Output voltage:<br>logic-0: 0.55 V (max) at -32 mA<br>logic-1: 3.8 V (min) at 32 mA  |

**Table E.4 – Output electrical specifications**