



# ***Inverted Magnetron Pirani Gauge***

*FRG-700  
FRG-702*

Short Operating Instructions

# ***Inverted Magnetron Pirani Gauge*** **FRG-700 FRG-702**

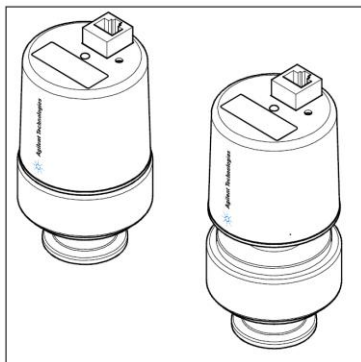

Declaration of Conformity  
Konformitätserklärung  
Déclaration de Conformité  
Declaración de Conformidad  
Verklaring de Overeenstemming  
Dichiarazione di Conformità

一致性声明  
適合宣言  
적합성 선언

We  
Wir  
Nous  
Nosotros  
Wij  
Noi  
我们  
私たち  
우리는



Agilent Technologies



Agilent Technologies  
121 Hartwell Ave.  
Lexington, MA 02421-3133 USA

declare under our sole responsibility that the product,  
erklären, in alleniniger Verantwortung, daß dieses Produkt,  
déclarons sous notre seule responsabilité que le produit,  
declaramos, bajo nuestra sola responsabilidad, que el producto,  
verklaren onder onze verantwoordelijkheid, dat het product,  
dichiariamo sotto nostra unica responsabilità, che il prodotto,  
基于独立承担责任的的原则, 特声明  
は、当社単独の責任の下、この宣言が該当する製品  
당사의 책임하에

#### Inverted Magnetron Pirani Gauge FRG-700 FRG-702

to which this declaration relates is in conformity with the following standard(s) or other normative documents.  
auf das sich diese Erklärung bezieht, mit der/den folgenden Norm(en) oder Richtlinie(n) übereinstimmt.  
auquel se réfère cette déclaration est conforme à la (auz) norme(s) ou au(x) document(s) normatif(s).  
al que se refere esta declaración es conforme a la(s) norma(s) u otro(s) documento(s) normativo(s).  
waarnaar deze verklaring verwijst, aan de volende norm(en) of richtlijn(en) beantwoordt.  
a cui se riferisce questa dichiarazione è conforme alla/e seguente/i norma/o documento/i normativo/i.  
符合以下标准或其它标准文档要求。



が、以下の規格またはその他の基準書類に適合することを宣言します。  
이 선언과 관련한 제품이 다음의 표준과 기타 표준 문서를 준수한다는 것을 선언합니다.

- EN 61000 6 2:2005 (EMC: generic immunity standard)
- EN 61000 6 3:2007 (EMC: generic emission standard)
- EN 61010 1:2001 (Safety requirements for electrical equipment for measurement, control and laboratory use)
- EN 61326:2006 (EMC requirements for electrical equipment for measurement, control and laboratory use)

John Ehmann  
Operations Manger  
Agilent, Inc.  
Vacuum products Division  
Lexington, MA USA

# Contents

Product Identification	5
Validity	5
Intended Use	6
Functional Principle	6
<b>1 Safety</b>	<b>7</b>
1.1 Symbols Used	7
1.2 Personnel Qualifications	7
1.3 General Safety Instructions	7
1.4 Liability and Warranty	9
<b>2 Technical Data</b>	<b>10</b>
<b>3 Installation</b>	<b>17</b>
3.1 Vacuum Connection	177
3.2 Power Connection	18
<b>4 Operation</b>	<b>233</b>
4.1 Gas Type Dependence	233
4.2 Ignition Delay	23
4.3 Adjusting the Gauge	244
<b>5 Deinstallation</b>	<b>277</b>
<b>6 Maintenance, Troubleshooting</b>	<b>288</b>
<b>7 Returning the Product</b>	<b>299</b>
<b>8 Disposal</b>	<b>30</b>
<b>9 Literature</b>	<b>31</b>

For cross-references within this document, the symbol (→  XY) is used, for cross-references to further documents, listed under literature, the symbol (→  [Z]).

## Product Identification

In all communications with Agilent, please specify the information given on the product nameplate. For convenient reference copy that information into the space provided below.

Agilent Technologies	
Model: _____	
PN: _____	
SN: _____	
_____ V _____ Hz _____ VA	
Made in Liechtenstein	

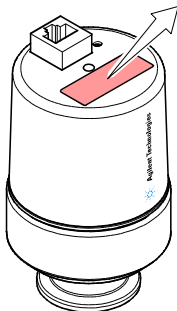

## Validity

This document applies to products with the following part numbers:

<b>FRG-700 (FPM sealed)</b>	<b>FRG-702 (all-metal)</b>
FRG700KF25 (DN 25 ISO-KF)	FRG702KF25 (DN 25 ISO-KF)
FRG700CF35 (DN 40 CF-F)	FRG702KF40 (DN 40 ISO-KF)
	FRG702CF35 (DN 40 CF-F)

The part number (PN) can be taken from the product nameplate.

## **Inverted Magnetron Pirani Gauge FRG-700 FRG-702**

If not indicated otherwise in the legends, the illustrations in this document correspond to the product with part number FRG700KF25. They apply to the other products by analogy.

We reserve the right to make technical changes without prior notice.

All dimensions in mm.

### **Intended Use**

The Inverted Magnetron Pirani Gauges FRG-700 and FRG-702 have been designed for vacuum measurement of gases in the pressure range of  $5 \times 10^{-9}$  ... 1000 mbar.

They must not be used for measuring flammable or combustible gases in mixtures containing oxidants (e.g. atmospheric oxygen) within the explosion range.

The gauges can be operated in connection with an Agilent AGC-100 Vacuum Gauge Controller, an Agilent Turbo AG Rack Controller, or with another controller.

### **Functional Principle**

The gauges consist of two separate measurement systems (Pirani and cold cathode system) the signals of which are combined in such a way that one measurement signal is output. The Pirani measurement circuit is always on.

# 1 Safety

## 1.1 Symbols Used



**DANGER**

Information on preventing any kind of physical injury.



**WARNING**

Information on preventing extensive equipment and environmental damage.



**Caution**

Information on correct handling or use. Disregard can lead to malfunctions or minor equipment damage.



Notice

## 1.2 Personnel Qualifications





**Skilled personnel**

All work described in this document may only be carried out by persons who have suitable technical training and the necessary experience or who have been instructed by the end-user of the product.

### 1.3 General Safety Instructions

- Adhere to the applicable regulations and take the necessary precautions for the process media used.  
Consider possible reactions with the product materials.  
Consider possible reactions (e.g. explosion) of the process media due to the heat generated by the product.
- Adhere to the applicable regulations and take the necessary precautions for all work you are going to do and consider the safety instructions in this document.
- Before beginning to work, find out whether any vacuum components are contaminated. Adhere to the relevant regulations and take the necessary precautions when handling contaminated parts.

 <b>DANGER</b>	
	<b>DANGER: magnetic fields</b> Strong magnetic fields can disturb electronic devices like heart pacemakers or impair their function.
	Maintain a safety distance of $\geq 10$ cm between the magnet and the heart pacemaker or prevent the influence of strong magnetic fields by antimagnetic shielding.

Communicate the safety instructions to all other users.



## 1.4 Liability and Warranty



Agilent assumes no liability and the warranty becomes null and void if the end-user or third parties

- disregard the information in this document
- use the product in a non-conforming manner
- make any kind of interventions (modifications, alterations etc.) on the product
- use the product with accessories not listed in the product documentation.

The end-user assumes the responsibility in conjunction with the process media used.



Gauge failures due to contamination or wear and tear, as well as expendable parts (e.g. seals, filament), are not covered by the warranty.

## 2 Technical Data

Measuring range (air, N <sub>2</sub> )	5×10 <sup>-9</sup> ... 1000 mbar
Accuracy	≈±30% (in the range 1×10 <sup>-8</sup> ... 100 mbar)
Repeatability	≈±5% (in the range 1×10 <sup>-8</sup> ... 100 mbar)
<hr/>	
Output signal (measuring signal)	
Voltage range	0 ... +10.5 V
Measurement range	1.82 ... 8.6 V
Voltage vs. pressure	logarithmic , 0.6 V/decade
Error signal	<0.5 V no supply >9.5 V Pirani sensor defective (filament rupture)
<hr/>	
Output impedance	2×10 Ω
Minimum loaded impedance	10 kΩ, short-circuit proof
Response time	(pressure dependent)
p > 10 <sup>-6</sup> mbar	<10 ms
p = 10 <sup>-8</sup> mbar	≈1000 ms
<hr/>	
Identification gauge	85 kΩ, referenced to supply common
<hr/>	
Status	pin 6
p > 10 <sup>-2</sup> mbar Pirani-only mode	 Low = 0 V
p < 10 <sup>-2</sup> mbar Cold cathode not ignited Pirani-only mode	 Low = 0 V
p < 10 <sup>-2</sup> mbar Cold cathode ignited Combined Pirani / cold cathode mode	 High = 15 ... 30 VDC
LED	High voltage on (LED on)

## Inverted Magnetron Pirani Gauge FRG-700 FRG-702

### Supply

	 <b>DANGER</b>
<p>The gauge may only be connected to power supplies, instruments or control devices that conform to the requirements of a grounded protective extra-low voltage (SELV). The connection to the gauge has to be fused <sup>1)</sup>.</p>	

Voltage at the gauge	15 ... 30 VDC (ripple $\leq 1 V_{pp}$ )
Power consumption	$\leq 2$ W
Fuse <sup>1)</sup>	$\leq 1$ AT
Voltage at the supply unit with maximum cable length	16 ... 30 VDC (ripple $\leq 1 V_{pp}$ ) <sup>2)</sup>
Adjustment	
Potentiometer <HV>	adjustment under $10^{-4}$ mbar
Potentiometer <ATM>	adjustment at atmospheric pressure
Electrical connection	FCC68 socket, 8-pin
Sensor cable	8-pin, shielded
Line length	$\leq 50$ m      ( $8 \times 0.14$ mm <sup>2</sup> )
Operating voltage	$\leq 3.3$ kV
Operating current	$\leq 500$ $\mu$ A
Grounding concept	→ "Electrical Connection"
Vacuum connection –measuring common	connected via 10 k $\Omega$ (max. voltage differential with respect to safety $\pm 50$ V accuracy $\pm 10$ V)
Supply common – signal common	conducted separately

<sup>1)</sup> Agilent controllers fulfill this requirement.

<sup>2)</sup> The minimum voltage of the power supply unit must be increased proportionally to the length of the sensor cable.

## Inverted Magnetron Pirani Gauge FRG-700 FRG-702

### Materials on the vacuum side

Vacuum connection	stainless steel
Measurement chamber	stainless steel
Feedthrough isolation	ceramic
Internal seal	
FRG-700	FPM 75
FRG-702	Ag, Cu, soft solder (Sn, Ag)
Anode	Mo
Ignition aid	stainless steel
Pirani measurement tube	Ni, Au
Pirani filament	W
Internal volume	≈20 cm <sup>3</sup>
Pressure	≤10 bar (absolute), limited to inert gases

---

### Temperatures

Operation	
FRG-700	+5 ... +55 °C
FRG-702	+5 ... +150 °C <sup>3)</sup>
Bakeout	150 °C (without electronics and magnetic shielding)
Pirani filament	120 °C
Storage	-40 ... +65 °C
Relative humidity	≤80% at temperatures ≤+31°C decreasing to 50% at +40°C
Mounting orientation	any
Use	indoors only, altitude up to 2000 m
Degree of protection	IP 40

---

<sup>3)</sup> Up to 150 °C at the flange if mounted horizontally; without magnetic shielding.

## Inverted Magnetron Pirani Gauge FRG-700 FRG-702

### Dimensions [mm]

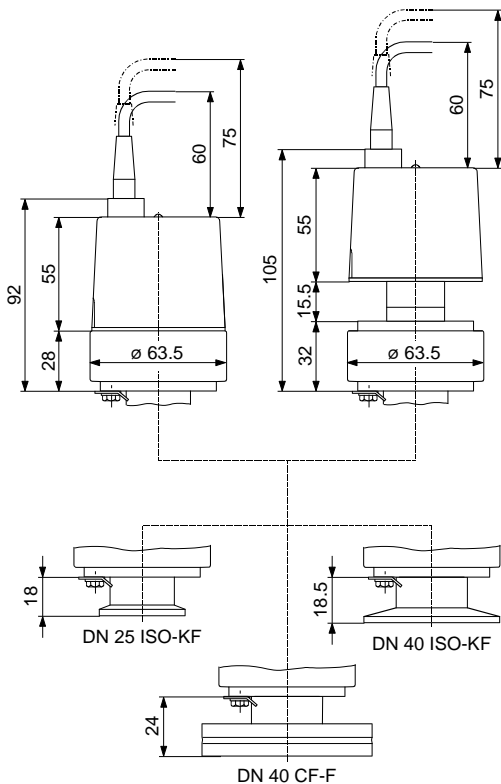

## Inverted Magnetron Pirani Gauge FRG-700 FRG-702

Weight

FRG700KF25	≈700 g	FRG702KF25	≈730 g
FRG700CF35	≈980 g	FRG702KF40	≈750 g
		FRG702CF35	≈1010 g

### Measuring Signal vs. Pressure

Pressure p

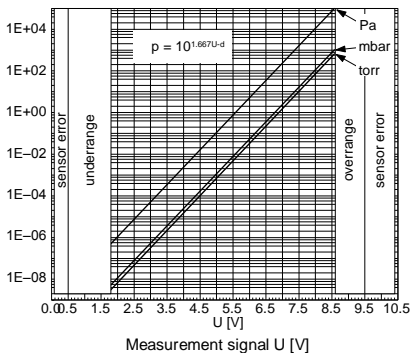

$$p = 10^{1.667 \times U - d} \quad \Leftrightarrow \quad U = c + 0.6 \log_{10} p$$

	mbar	Pa	Torr
d	11.33	9.33	11.46
c	6.8	5.6	6.875

valid in the range  $5 \times 10^{-9}$  mbar  $< p < 1000$  mbar  
 $3.8 \times 10^{-9}$  Torr  $< p < 750$  Torr  
 $5 \times 10^{-7}$  Pa  $< p < 1 \times 10^5$  Pa

## Gas Type Dependence

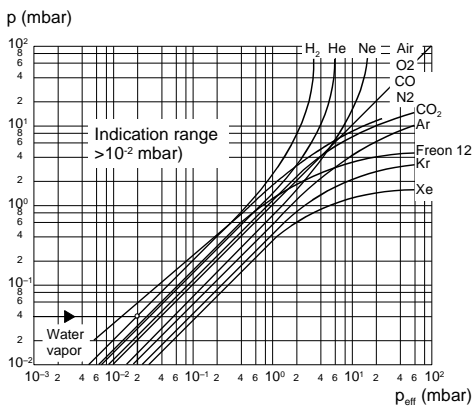

## Inverted Magnetron Pirani Gauge FRG-700 FRG-702

p (mbar)

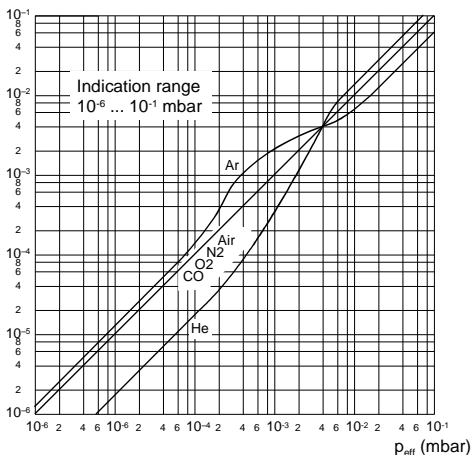

In the range below  $10^{-5}$  mbar, the pressure indication is linear. For gases other than air, the pressure can be determined by means of a simple conversion formula:

$$p_{\text{eff}} = K \times \text{pressure reading}$$

Where

Gas type	K (mean values)
Air (O <sub>2</sub> , CO, N <sub>2</sub> )	1.0
Xe	0.4
Kr	0.5
Ar	0.8
H <sub>2</sub>	2.4
Ne	4.1
He	5.9



## 3 Installation

### 3.1 Vacuum Connection

 **DANGER**



**DANGER:** overpressure in the vacuum system  
>1 bar

Injury caused by released parts and harm caused by escaping process gases can result if clamps are opened while the vacuum system is pressurized.

Do not open any clamps while the vacuum system is pressurized. Use the type clamps which are suited to overpressure.

 **DANGER**



**DANGER:** overpressure in the vacuum system  
>2.5 bar

KF flange connections with elastomer seals (e.g. O-rings) cannot withstand such pressures. Process media can thus leak and possibly damage your health.

Use O-rings provided with an outer centering ring.



**DANGER**



**DANGER:** protective ground

Products that are not correctly connected to ground can be extremely hazardous in the event of a fault.

Electrically connect the gauge to the grounded vacuum chamber. This connection must conform to the requirements of a protective connection according to EN 61010:

- CF flanges fulfill this requirement.
- For gauges with a KF flange, use a conductive metallic clamping ring.



**Caution**



**Caution:** vacuum component

Dirt and damages impair the function of the vacuum component.

When handling vacuum components, take appropriate measures to ensure cleanliness and prevent damages.



**Caution**



**Caution:** dirt sensitive area

Touching the product or parts thereof with bare hands increases the desorption rate.

Always wear clean, lint-free gloves and use clean tools when working in this area.



**WARNING**



**WARNING:** electric arcing

Helium may cause electric arcing with detrimental effects on the electronics of the product.

Before performing any tightness tests put the product out of operation and remove the electronics unit.



The gauge may be mounted in any orientation. To keep condensates and particles from getting into the measuring chamber preferably choose a horizontal to upright position and possibly use a seal with a centering ring and filter.



If adjustment should be possible after the gauge has been installed, be sure to install it so that potentiometers <HV> and <ATM> can be accessed with a screwdriver (→ "Adjusting the Gauge").

## Inverted Magnetron Pirani Gauge FRG-700 FRG-702



When making a CF flange connection, it can be advantageous to temporarily remove the electronics and the magnet unit.

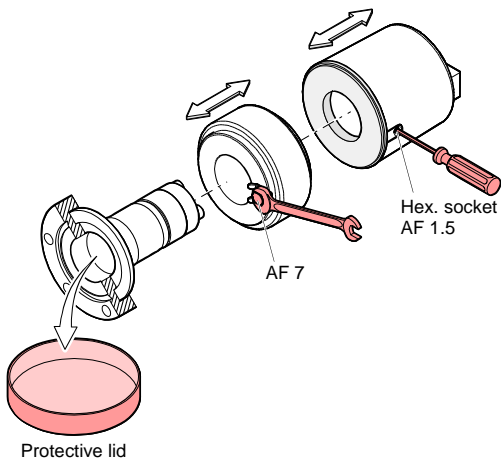

Keep the protective lid.

## Inverted Magnetron Pirani Gauge FRG-700 FRG-702

Remove the protective lid and connect the product to the vacuum system.

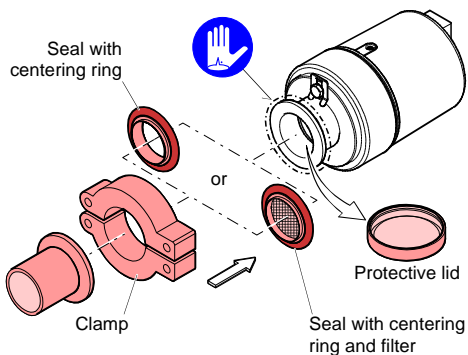

Keep the protective lid.

## 3.2 Power Connection



Make sure the vacuum connection is properly made (→ "Vacuum Connection").

**1**

If no sensor cable is available, make one according to the following diagram.

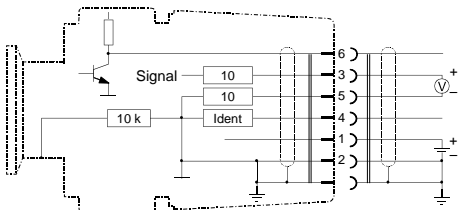

### Electrical connection

Pin 1	Supply (15 ... 30 VDC)
Pin 2	Supply common
Pin 3	Signal output (measuring signal)
Pin 4	Identification
Pin 5	Signal common
Pin 6	Status
Pin 7, 8	n.c.

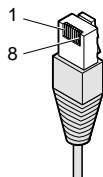

8-pin FCC-68

**2**

Connect the gauge to the controller using the sensor cable.

## 4 Operation

When the supply voltage is applied, the measuring signal is available between pins 3 and 5. Over the whole measurement range, the measuring signal is output as a logarithm of the pressure (measuring signal vs. pressure → "Technical Data").

Allow for a stabilizing time of  $\approx 10$  minutes. Once the gauge has been switched on, permanently leave it on irrespective of the pressure.

- The Pirani measurement circuit is always on.
- The cold cathode measurement circuit is controlled by the Pirani circuit and is activated only at pressures  $< 1 \times 10^{-2}$  mbar.

### 4.1 Gas Type Dependence

The measurement value depends on the type of gas being measured. The value displayed is accurate for dry air, O<sub>2</sub>, CO and N<sub>2</sub>. It can be mathematically converted for other gases (→ "Technical Data").

If the gauge is operated in connection with an Agilent vacuum gauge controller, a calibration factor can be entered for correction of the reading.

### 4.2 Ignition Delay

When cold cathode measurement systems are activated upon switching the gauge on, an ignition delay occurs, which is typically:

$10^{-5}$ mbar	$\approx$ 1 second
$10^{-7}$ mbar	$\approx$ 20 seconds
$5 \times 10^{-9}$ mbar	$\approx$ 2 minutes

As long as the cold cathode measurement circuit has not yet ignited, the measurement value of the Pirani is output as measuring signal.

### 4.3 Adjusting the Gauge

The gauge is factory-calibrated. If used under different climatic conditions, through extreme temperatures, aging or contamination, and after exchanging the sensor, the characteristic curve can be offset and readjustment may become necessary.

The cold cathode measurement circuit, which is dominant for low pressures ( $<1 \times 10^{-3}$  mbar), is factory-calibrated. By way of contrast, the Pirani measurement circuit can be adjusted. Any adjustment has a negligible effect on the pressure range between approx.  $10^{-2}$  mbar and  $10^2$  mbar.

- 1** If you are using a seal with centering ring and filter, check that they are clean or replace them if necessary (→ "Deinstallation").
- 2** Activate the gauge.
- 3** Evacuate it to  $p \ll 10^{-4}$  mbar and wait at least 10 minutes.
- 4** Turn the nameplate counter-clockwise until the mechanical stop is reached.



## Inverted Magnetron Pirani Gauge FRG-700 FRG-702

5

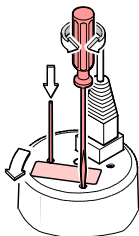

While depressing the tactile switch with a cylindrical pin ( $\varnothing \approx 3$  mm), adjust the <HV> potentiometer by means of a 1.5 mm screwdriver ...

... to 4.20 V

or ... to  $5 \times 10^{-4}$  mbar

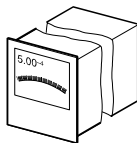

After that, turn the potentiometer counter-clockwise by 1/3 of a turn.

6

Vent the gauge with air or nitrogen to atmospheric pressure, and wait at least 10 minutes.

7

Turn the nameplate clockwise until the mechanical stop is reached.

## Inverted Magnetron Pirani Gauge FRG-700 FRG-702

8

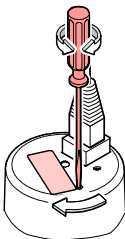

Using the 1.5 mm screwdriver, adjust the <ATM> potentiometer ...

... to 8.60 V

or ... to  $1 \times 10^3$  mbar

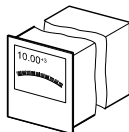

9 Turn the nameplate back to its original position (it catches).

## 5 Deinstallation

 **DANGER**



**DANGER:** contaminated parts

Contaminated parts can be detrimental to health and environment.

Before beginning to work, find out whether any parts are contaminated. Adhere to the relevant regulations and take the necessary precautions when handling contaminated parts.



**Caution**



**Caution:** vacuum component

Dirt and damages impair the function of the vacuum component.

When handling vacuum components, take appropriate measures to ensure cleanliness and prevent damages.



**Caution**



**Caution:** dirt sensitive area

Touching the product or parts thereof with bare hands increases the desorption rate.

Always wear clean, lint-free gloves and use clean tools when working in this area.

- 1** Vent the vacuum system.

## Inverted Magnetron Pirani Gauge FRG-700 FRG-702

- 2** Put the gauge out of operation and unplug the sensor cable.
- 3** Remove the gauge from the vacuum system and place the protective lid.



When deinstalling a CF flange connection, it can be advantageous to temporarily remove the electronics and the magnet unit (→  20).

## 6 Maintenance, Troubleshooting

→  Operating Manual tqna74e1 under [www.agilent.com](http://www.agilent.com)



If operated at high pressures or under dirty conditions, the gauge must be regularly cleaned.

Gauge failures due to contamination or wear and tear, as well as expendable parts (e.g. seals, filament), are not covered by the warranty.

## 7 Returning the Product



### WARNING

WARNING: forwarding contaminated products  
Contaminated products (e.g. radioactive, toxic, caustic or microbiological hazard) can be detrimental to health and environment.

Products returned to Agilent should preferably be free of harmful substances. Adhere to the forwarding regulations of all involved countries and forwarding companies and enclose a duly completed declaration of contamination.

Products that are not clearly declared as "free of harmful substances" are decontaminated at the expense of the customer. Products not accompanied by a duly completed declaration of contamination are returned to the sender at his own expense.

## 8 Disposal



### DANGER



**DANGER:** contaminated parts

Contaminated parts can be detrimental to health and environment.

Before beginning to work, find out whether any parts are contaminated. Adhere to the relevant regulations and take the necessary precautions when handling contaminated parts.



### WARNING



**WARNING:** substances detrimental to the environment

Products or parts thereof (mechanical and electric components, operating fluids etc.) can be detrimental to the environment.



Dispose of such substances in accordance with the relevant local regulations.

### Separating the components

After disassembling the product, separate its components according to the following criteria:

- Contaminated components  
Contaminated components (radioactive, toxic, caustic or biological hazard etc.) must be decontaminated in accordance with the relevant national regulations, separated according to their materials, and disposed of.
- Other components  
Such components must be separated according to their materials and recycled.

## 9 Literature

-  [1] [www.agilent.com](http://www.agilent.com)  
Operating Manual  
Inverted Magnetron Pirani Gauge FRG-700, FRG 702  
tqna74e1  
Agilent Technologies, Lexington, MA 02421, USA
  
-  [2] [www.agilent.com](http://www.agilent.com)  
Operating Manual  
AGC-100 Vacuum Gauge Controller  
tqnb15e1  
Agilent Technologies, Lexington, MA 02421, USA

**Notes**





**Vacuum Products Division  
Instructions for returning products**

Dear Customer:

Please follow these instructions whenever one of our products needs to be returned.

- 1) Complete the attached Request for Return form and send it to Agilent Technologies (see below), taking particular care to identify all products that have pumped or been exposed to any toxic or hazardous materials.
- 2) After evaluating the information, Agilent Technologies will provide you with a Return Authorization (RA) number via email or fax, as requested.  
**Note:** Depending on the type of return, a Purchase Order may be required at the time the Request for Return is submitted. We will quote any necessary services (evaluation, repair, special cleaning, eg).
- 3) **Important steps for the shipment of returning product:**
  - Remove all accessories from the core product (e.g. inlet screens, vent valves).
  - Prior to shipment, drain any oils or other liquids, purge or flush all gasses, and wipe off any excess residue.
  - If ordering an Advance Exchange product, **please use the packaging from the Advance Exchange to return the defective product.**
  - Seal the product in a plastic bag, and package product carefully to avoid damage in transit. You are responsible for loss or damage in transit.
  - Agilent Technologies is not responsible for returning customer provided packaging or containers.
  - **Clearly label package with RA number.** Using the shipping label provided will ensure the proper address and RA number are on the package. Packages shipped to Agilent without a RA clearly written on the outside cannot be accepted and will be returned.
- 4) Return only products for which the RA was issued.
- 5) **Product being returned under a RA must be received within 15 business days.**
- 6) **Ship to the location specified on the printable label, which will be sent, along with the RA number, as soon as we have received all of the required information.** Customer is responsible for freight charges on returning product.
- 7) Return shipments must comply with all applicable **Shipping Regulations** (IATA, DOT, etc.) and carrier requirements.

RETURN THE COMPLETED REQUEST FOR RETURN FORM TO YOUR NEAREST LOCATION:

**EUROPE:**

Fax: 00 39 011 9979 330  
Fax Free: 00 800 345 345 00  
Toll Free: 00 800 234 234 00  
[vpt-customer-care@agilent.com](mailto:vpt-customer-care@agilent.com)

**NORTH AMERICA:**

Fax: 1 781 860 9252  
Toll Free: 800 882 7426, Option 3  
[vpl-ra@agilent.com](mailto:vpl-ra@agilent.com)

**PACIFIC RIM:**

please visit our website for individual office information  
<http://www.agilent.com>



Please read important policy information on Page 3 that applies to all returns.

**1) CUSTOMER INFORMATION**

<b>Company Name:</b>		<b>Contact Name:</b>	
<b>Tel:</b>	<b>Email:</b>	<b>Fax:</b>	
<b>Customer Ship To:</b>		<b>Customer Bill To:</b>	
<b>Europe only: VAT reg. Number:</b>		<b>USA/Canada only:</b> <input type="checkbox"/> <b>Taxable</b> <input type="checkbox"/> <b>Non-taxable</b>	

**2) PRODUCT IDENTIFICATION**

Product Description	Agilent P/N	Agilent S/N	Original Purchasing Reference

**3) TYPE OF RETURN** (Choose one from each row and supply Purchase Order if requesting a billable service)

- 3A.  Non-Billable  Billable **➔** New PO # (hard copy must be submitted with this form):
- 3B.  Exchange  Repair  Upgrade  Consignment/Demo  Calibration  Evaluation  Return for Credit

**4) HEALTH and SAFETY CERTIFICATION**

**AGILENT TECHNOLOGIES CANNOT ACCEPT ANY PRODUCTS CONTAMINATED WITH BIOLOGICAL OR EXPLOSIVE HAZARDS, RADIOACTIVE MATERIAL, OR MERCURY AT ITS FACILITY.**  
**Call Agilent Technologies to discuss alternatives if this requirement presents a problem.**

**The equipment listed above (check one):**

**HAS NOT** pumped or been exposed to any toxic or hazardous materials. OR

**HAS** pumped or been exposed to the following toxic or hazardous materials. If this box is checked, the following information must also be filled out. Check boxes for all materials to which product(s) pumped or was exposed:

Toxic  Corrosive  Reactive  Flammable  Explosive  Biological  Radioactive

**List all toxic/hazardous materials. Include product name, chemical name, and chemical symbol or formula:**

---

**NOTE:** If a product is received at Agilent which is contaminated with a toxic or hazardous material that was not disclosed, **the customer will be held responsible** for all costs incurred to ensure the safe handling of the product, and **is liable** for any harm or injury to Agilent employees as well as to any third party occurring as a result of exposure to toxic or hazardous materials present in the product.

**Print Name:** \_\_\_\_\_ **Authorized Signature:** ..... **Date:** \_\_\_\_\_

**5) FAILURE INFORMATION:**

Failure Mode (REQUIRED FIELD. See next page for suggestions of failure terms):
Detailed Description of Malfunction: (Please provide the error message)
Application (system and model):

**I understand and agree to the terms of Section 6, Page 3/3.**

**Print Name:** \_\_\_\_\_ **Authorized Signature:** ..... **Date:** \_\_\_\_\_



Please use these Failure Mode to describe the concern about the product on Page 2.

**TURBO PUMPS and TURBO CONTROLLERS**

APPARENT DEFECT/MALFUNCTION	POSITION	PARAMETERS
- Does not start - Does not spin freely - Does not reach full speed - Mechanical Contact - Cooling defective	- Noise - Vibrations - Leak - Overtemperature - Clogging	- Vertical - Horizontal - Upside-down - Other: ..... OPERATING TIME:
		Power:                   Rotational Speed: Current:                Inlet Pressure: Temp 1:                 Foreline Pressure: Temp 2:                 Purge flow:

**ION PUMPS/CONTROLLERS**

- Bad feedthrough	- Poor vacuum
- Vacuum leak	- High voltage problem
- Error code on display	- Other

**VALVES/COMPONENTS**

- Main seal leak	- Bellows leak
- Solenoid failure	- Damaged flange
- Damaged sealing area	- Other

**LEAK DETECTORS**

- Cannot calibrate	- No zero/high background
- Vacuum system unstable	- Cannot reach test mode
- Failed to start	- Other

**INSTRUMENTS**

- Gauge tube not working	- Display problem
- Communication failure	- Degas not working
- Error code on display	- Other

**SCROLL AND ROTARY VANE PUMPS**

- Pump doesn't start	- Noisy pump (describe)
- Doesn't reach vacuum	- Over temperature
- Pump seized	- Other

**DIFFUSION PUMPS**

- Heater failure	- Electrical problem
- Doesn't reach vacuum	- Cooling coil damage
- Vacuum leak	- Other

Section 6) **ADDITIONAL TERMS**

**Please read the terms and conditions below as they apply to all returns and are in addition to the Agilent Technologies Vacuum Product Division – Products and Services Terms of Sale.**

- Customer is responsible for the freight charges for the returning product. Return shipments must comply with all applicable **Shipping Regulations** (IATA, DOT, etc.) and carrier requirements.
- Customers receiving an **Advance Exchange** product agree to return the defective, rebuildable part to Agilent Technologies **within 15 business days**. Failure to do so, or returning a non-rebuildable part (crashed), will result in an invoice for the non-returned/non-rebuildable part.
- Returns for credit toward the purchase of new or refurbished Products are subject to prior Agilent approval and may incur a restocking fee. Please reference the original purchase order number.
- Units returned for evaluation will be evaluated, and a quote for repair will be issued. If you choose to have the unit repaired, the cost of the evaluation will be deducted from the final repair pricing. A Purchase Order for the final repair price should be issued within 3 weeks of quotation date. Units without a Purchase Order for repair will be returned to the customer, and the evaluation fee will be invoiced.
- A Special Cleaning fee will apply to all exposed products per Section 4 of this document.
- If requesting a calibration service, units must be functionally capable of being calibrated.

## Service & Support

### North America

Agilent Technologies  
121 Hartwell Avenue  
Lexington, MA 02421 USA  
Tel: +1 781 861 7200  
Toll-Free: +1 800 882 7426  
Fax: +1 781 860 5437  
vpl-customerservice@agilent.com

### Benelux

Agilent Technologies Netherlands B.V.  
Herculesweg 8  
4338 PL Middelburg The Netherlands  
Tel: +31 118 671570  
Fax: +31 118 671569  
Toll free: 00 800 234 234 00

### China

Agilent Technologies (China) Co. Ltd  
No.3, Wang Jing Bei Lu,  
Chao Yang District, Beijing,  
100102 China Tel: +86  
(10) 6439 7888  
Fax: +86 (10) 6439 1318  
Toll-Free: 800 820 8266  
vpc-customerservice@agilent.com

### France

Agilent Technologies France  
7 avenue des Topiques  
Z.A. de Courtaboeuf - B.P. 12  
91941 Les Ulis cedex France  
Tel: +33 (0) 1 69 86 38 84  
Fax: +33 (0) 1 69 86 29 88  
Toll free: 00 800 234 234 00  
vpt.sales@agilent.com

### Germany & Austria

Agilent Technologies  
Lyoner Str. 20  
60 528 Frankfurt am Main Germany  
Tel: +49 69 6773 43 2230  
Fax: +49 69 6773 43 2250  
Toll free: 00 800 234 234 00

### India

Agilent Technologies India Pvt. Ltd.  
G01, Prime corporate Park,  
230/231, Sahar Road,  
Opp. Blue Dart Centre,  
Andheri (East), Mumbai - 400 099 India  
Tel: +91 22 30648287/8200  
Fax: +91 22 30648250  
Toll Free: 1800 113037  
cag\_india@agilent.com

### Italy

Agilent Technologies Italia S.p.A.  
via F.lli Vantani 54  
10040 Leini, (Torino) Italy  
Tel: +39 011 997 9111  
Fax: +39 011 997 9350  
Toll-Free: 00 800 234 234 00  
vpt.sales@agilent.com  
vpc-customerservice@agilent.com

### Japan

Agilent Technologies Japan, Ltd.  
8th Floor  
Sumitomo Shibaura Building  
4-16-36 Shibaura Minato-ku  
Tokyo 108-0023 Japan  
Tel: +81 3 5232 1253  
Toll-Free: 0120 655 040  
Fax: +81 3 5232 1710  
vpj-customerservice@agilent.com

### Korea

Agilent Technologies Korea Ltd.  
Shinsa 2nd Bldg. 2F  
966-5 Daechi-dong  
Kangnam-gu, Seoul Korea 135-280  
Tel: +82 2 3452 2455  
Toll-Free: 080 222 2452  
Fax: +82 2 3452 2451  
vpl-customerservice@agilent.com

### Singapore

Agilent Technologies Singapore Pte Ltd  
No.1 Vishnu Avenue 7 Singapore 768923  
Tel: +65 6215 8045  
Fax: +65 6754 0574  
Toll-Free: 1 800 2762622  
vps-customerservice@agilent.com

### South East Asia

Agilent Technologies Sales Sdn Bhd  
Unit 201, Level 2 Uptown 2,  
2 Jalan SS21/37, Damansara Uptown  
47400 Petaling Jaya, Selangor, Malaysia  
Tel: +603 7712 6106  
Fax: +603 6733 8121  
Toll-Free: 1 800 880 8005  
vpi-customerservice@agilent.com

### Taiwan

Agilent Technologies Taiwan Limited  
20 Kao-Shuang Rd.,  
Pin-Chen City, 324  
Taoyuan Hsien, Taiwan, R.O.C.  
Tel: +886 348959281  
Toll Free: 0800 051 342  
vpu-customerservice@agilent.com

### UK & Ireland

Agilent Technologies UK Ltd  
6 Mead Road  
Oxford Industrial Park  
Yarnton, Oxford OX5 1QU UK  
Tel: +44 (0) 1865 291570  
Fax: +44 (0) 1865 291571  
Toll free: 00 800 234 234 00  
vpt-customerservice@agilent.com

This information is subject to change without notice.

© Agilent Technologies, Inc., 2011  
Published in USA, October, 2011



Agilent Technologies



t q ma 7 4 e 1

Learn more:

[www.agilent.com/chem/vacuum](http://www.agilent.com/chem/vacuum)